



[WWW.GEKOSHOP.IT](http://WWW.GEKOSHOP.IT)



PREZZI IVA E TRASPORTO ESCLUSI

Via Professor Filippo Manna 27 - Complesso Millefiori

INFO@GEKOSHOP.IT - INFO: 081 18214718





# LISTINO PREZZI 2025 VERS. 1.1

VALIDO A PARTIRE DAL 01/11/2024



**SISTEMI ESPOSITIVI VERS 1.0**

**PAG 1**



**COMUNICAZIONE PREZZO VERS.  
1.0**

**PAG 61**



**COMUNICAZIONE GLOBALE  
VERS. 1.0**

**PAG 170**



**ACCESSORI AREA VENDITA VERS.  
1.0**

**PAG 200**



**EXPOWORLD VERS. 1.0**

**PAG 233**



**IGIENE E AMBIENTE  
VERS. 1.0**

**PAG 251**



**GESTIONE CODE E  
VIDEOCOMUNICAZIONE  
VERS. 1.0**

**PAG 267**





**PREZZATRICI, ETICHETTE E  
ROTOLI VERS. 1.0**

**PAG 290**



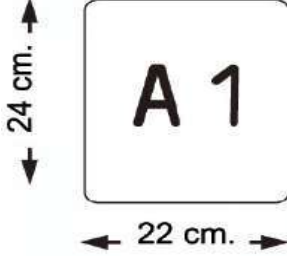

## COLOURS

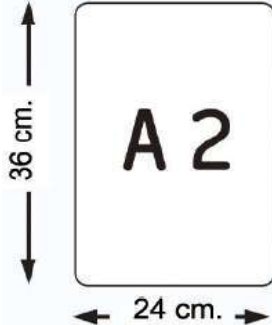
01	WHITE	21	BEIGE	52	GREEN
02	BLUE	22	LIGHT GREY	53	ORANGE
03	YELLOW	23	PURPLE	54	FUCHSIA
04	BROWN	24	PINK	<b>WOOD TEXTURE</b>	
05	BLACK	31	STEEL	55	PINE TREE
06	RED	32	ECRU	56	FIR TREE
07	GREEN	33	EARTHENWARE	57	CHERRY TREE
08	TRANSPARENT	34	LIGHT WOOD	58	ASH TREE
09	ORANGE	35	DARK WOOD	59	WALNUT TREE
10	DARK GREY	98	NATURAL COLOR	60	ROSEWOOD
12	SILVER	99	UNDEFINED	W1	WOOD 1
13	LIGHT BLUE	<b>FLUORESCENT COLOURS</b>		W2	WOOD 2
14	FUCHSIA	50	YELLOW	W3	WOOD 3
17	GOLD	51	RED	W4	WOOD 4



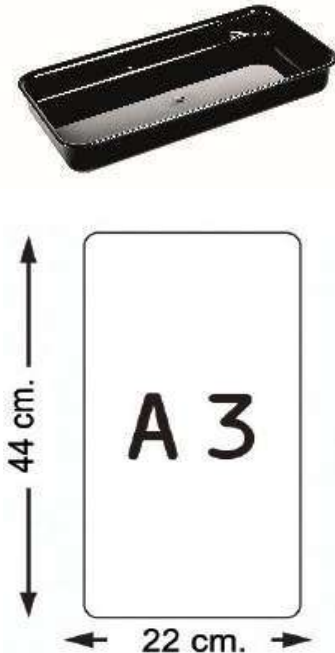

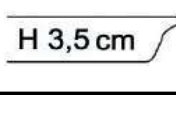
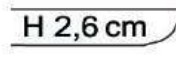

# SISTEMI ESPOSITIVI

IMMAGINE	DESCRIZIONE	CODICE E COLORE	PAG CAT	PREZZO	NOTE
 	VASSOIO TRAY MODELLO A1 CON BORDO VIVO PMMAD: 24 x 22 x 8,5 H cm PESO: 0,375 KG <b>H 8,5 cm.</b>	SECTP18501	9	€ 10,80	
		SECTP18505	9	€ 10,61	
	VASSOIO TRAY MODELLO A1 CON BORDO VIVO PMMA D: 24 x 22 x 5 H cm PESO: 0,289 KG <b>H 5 cm.</b>	SECTP15001	9	€ 9,24	
		SECTP15005	9	€ 9,06	
	VASSOIO TRAY MODELLO A1 CON BORDO VIVO PMMA D: 24 x 22 x 3,5 H cm PESO: 0,252 KG <b>H 3,5 cm.</b>	SECTP13501	9	€ 8,47	
		SECTP13505	9	€ 8,31	
 	VASSOIO TRAY MODELLO A2 CON BORDO VIVO PMMA D: 36 x 24 x 8,5 H cm PESO: 0,590 KG <b>H 8,5 cm.</b>	SECTP28501	9	€ 15,41	
		SECTP28505	9	€ 15,13	
	VASSOIO TRAY MODELLO A2 CON BORDO VIVO PMMA D: 36 x 24 x 5 H cm PESO: 0,472 KG <b>H 5 cm.</b>	SECTP25001	9	€ 13,62	
		SECTP25005	9	€ 13,36	
	VASSOIO TRAY MODELLO A2 CON BORDO VIVO PMMA D: 36 x 24 x 3,5 H cm PESO: 0,424 KG <b>H 3,5 cm.</b>	SECTP23501	9	€ 12,24	
		SECTP23505	9	€ 12,01	

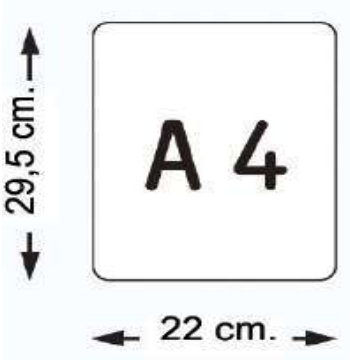
# SISTEMI ESPOSITIVI

IMMAGINE	DESCRIZIONE	CODICE E COLORE	PAG CAT	PREZZO	NOTE	
 <p>44 cm.</p> <p>A 3</p> <p>22 cm.</p>	VASSOIO TRAY MODELLO A3 CON BORDO STONDATO PMMA D: 44 x 22 x 8,5 H cm PESO: 0,704 KG 	SECTP38501	9	€ 16,45		
		SECTP38505	9	€ 16,14		
		VASSOIO TRAY MODELLO A3 CON BORDO STONDATO PMMA D: 44 x 22 x 5 H cm PESO: 0,545 KG 	SECTP35001	9	€ 13,38	
			SECTP35005	9	€ 13,14	
	VASSOIO TRAY MODELLO A3 CON BORDO STONDATO PMMA D: 44 x 22 x 3,5 H cm PESO: 0,476 KG 	SECTP33501	9	€ 11,90		
		SECTP33505	9	€ 11,66		
	VASSOIO TRAY MODELLO A3 CON BORDO STONDATO PMMA D: 44 x 22 x 2,6 H cm PESO: 0,437 KG 	SECTP32601	9	€ 10,91		
		SECTP32605	9	€ 10,71		



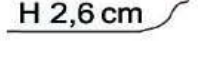
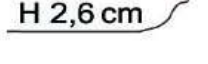
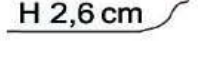

# SISTEMI ESPOSITIVI

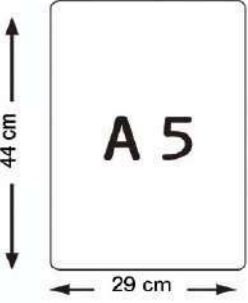
IMMAGINE	DESCRIZIONE	CODICE E COLORE	PAG CAT	PREZZO	NOTE
 <p>29,5 cm. →</p> <p>← 22 cm. →</p> <p><b>A 4</b></p>	VASSOIO TRAY MODELLO A4 CON BORDO STONDATO PMMA D: 29,5 x 22 x 8,5 H cm PESO: 0,493 KG 	SECTP48501	9	€ 11,17	
	VASSOIO TRAY MODELLO A4 CON BORDO STONDATO PMMA D: 29,5 x 22 x 5 H cm PESO: 0,374 KG 	SECTP48505	9	€ 10,96	
	VASSOIO TRAY MODELLO A4 CON BORDO STONDATO PMMA D: 29,5 x 22 x 5 H cm PESO: 0,374 KG 	SECTP45001	9	€ 8,94	
	VASSOIO TRAY MODELLO A4 CON BORDO STONDATO PMMA D: 29,5 x 22 x 3,5 H cm PESO: 0,322 KG 	SECTP45005	9	€ 8,78	
	VASSOIO TRAY MODELLO A4 CON BORDO STONDATO PMMA D: 29,5 x 22 x 3,5 H cm PESO: 0,322 KG 	SECTP43501	9	€ 7,78	
	VASSOIO TRAY MODELLO A4 CON BORDO STONDATO PMMA D: 29,5 x 22 x 2,6 H cm PESO: 0,292 KG 	SECTP43505	9	€ 7,64	
	VASSOIO TRAY MODELLO A4 CON BORDO STONDATO PMMA D: 29,5 x 22 x 2,6 H cm PESO: 0,292 KG 	SECTP42601	9	€ 7,22	
	VASSOIO TRAY MODELLO A4 CON BORDO STONDATO PMMA D: 29,5 x 22 x 2,6 H cm PESO: 0,292 KG 	SECTP42605	9	€ 7,09	

# SISTEMI ESPOSITIVI

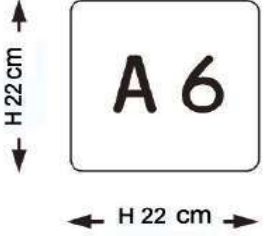
IMMAGINE	DESCRIZIONE	CODICE E COLORE	PAG CAT	PREZZO	NOTE
 	VASSOIO TRAY MODELLO A5 CON BORDO STONDATO PMMA D: 44 x 29 x 10 H cm PESO: 0,951 KG H 10 cm.	SECTP51001	9	€ 21,33	
		SECTP51005	9	€ 20,93	
	VASSOIO TRAY MODELLO A5 CON BORDO STONDATO PMMA D: 44 x 29 x 8,5 H cm PESO: 0.874 KG H 8,5 cm	SECTP58501	9	€ 19,71	
		SECTP58505	9	€ 19,35	
	VASSOIO TRAY MODELLO A5 CON BORDO STONDATO PMMA D: 44 x 29 x 5 H cm PESO: 0,695 KG H 5 cm	SECTP55001	9	€ 16,29	
		SECTP55005	9	€ 15,99	
	VASSOIO TRAY MODELLO A5 CON BORDO STONDATO PMMA D: 44 x 29 x 3,5 H cm PESO: 0,613 KG H 3,5 cm	SECTP53501	9	€ 14,60	
		SECTP53505	9	€ 14,32	
	VASSOIO TRAY MODELLO A5 CON BORDO STONDATO PMMA D: 44 x 29 x 2,6 H cm PESO: 0,575 KG H 2,6 cm	SECTP52601	9	€ 13,91	
		SECTP52605	9	€ 13,65	

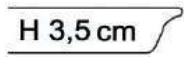
# SISTEMI ESPOSITIVI





IMMAGINE	DESCRIZIONE	CODICE E COLORE	PAG CAT	PREZZO	NOTE
 	VASSOIO TRAY MODELLO A6 CON BORDO STONDATO PMMA D: 22 x 22 x 8,5 H cm PESO: 0,390 KG 	SECTP68501	10	€ 9,17	
		SECTP68505	10	€ 9,01	
	VASSOIO TRAY MODELLO A6 CON BORDO STONDATO PMMA D: 22 x 22 x 5 H cm PESO: 0,290 KG 	SECTP65001	10	€ 7,12	
		SECTP65005	10	€ 6,99	
	VASSOIO TRAY MODELLO A6 CON BORDO STONDATO PMMA D: 22 x 22 x 3,5 H cm PESO: 0,246 KG 	SECTP63501	10	€ 6,30	
		SECTP63505	10	€ 6,19	
	VASSOIO TRAY MODELLO A6 CON BORDO STONDATO PMMA D: 22 x 22 x 2,6 H cm PESO: 0,222 KG 	SECTP62601	10	€ 5,87	
		SECTP62605	10	€ 5,76	

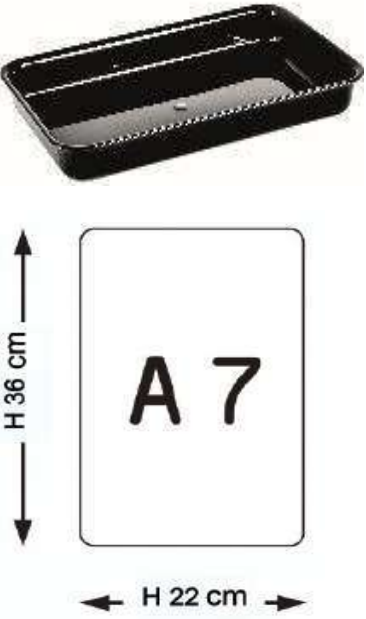

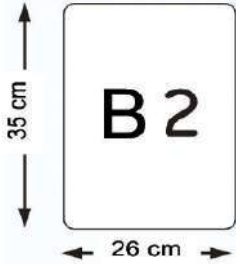
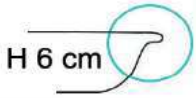

# SISTEMI ESPOSITIVI

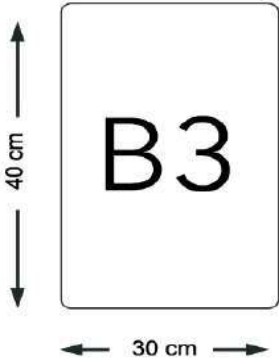
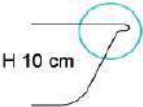
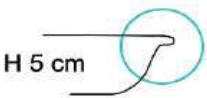
IMMAGINE	DESCRIZIONE	CODICE E COLORE	PAG CAT	PREZZO	NOTE
	VASSOIO TRAY MODELLO A7 CON BORDO STONDATO PMMA D: 36 x 22 x 8,5 H cm PESO: 0,585 KG <b>H 8,5 cm</b>	SECTP78501	10	€ 13,55	
		SECTP78505	10	€ 13,30	
	VASSOIO TRAY MODELLO A7 CON BORDO STONDATO PMMA D: 36 x 22 x 5 H cm PESO: 0,448 KG <b>H 5 cm</b>	SECTP75001	10	€ 10,91	
		SECTP75005	10	€ 10,71	
	VASSOIO TRAY MODELLO A7 CON BORDO STONDATO PMMA D: 36 x 22 x 3,5 H cm PESO: 0,389 KG <b>H 3,5 cm</b>	SECTP73501	10	€ 9,62	
		SECTP73505	10	€ 9,45	
	VASSOIO TRAY MODELLO A7 CON BORDO STONDATO PMMA D: 36 x 22 x 2,6 H cm PESO: 0,355 KG <b>H 2,6 cm</b>	SECTP72601	10	€ 8,76	
		SECTP72605	10	€ 8,60	

# SISTEMI ESPOSITIVI

IMMAGINE	DESCRIZIONE	CODICE E COLORE	PAG CAT	PREZZO	NOTE
 	<p>VASSOIO TRAY ANGOLI STONDATI NUOVO SISTEMA IMPILABILE B2-PMMA</p> <p>D: 35 x 26 x 6 H cm PESO: 0,501 KG</p> 	SECTPM6001	10	€ 21,04	
		SECTPM6005	10	€ 20,64	
 	<p>VASSOIO TRAY ANGOLI STONDATI IMPILABILE B3-PMMA</p> <p>D: 40 x 30 x 10 H cm PESO: 0,771 KG</p> 	SECTPN1001	10	€ 30,23	
		SECTPN1005	10	€ 29,67	
	<p>VASSOIO TRAY ANGOLI STONDATI IMPILABILE B3-PMMA</p> <p>D: 40 x 30 x 5 H cm PESO: 0,643 KG</p> 	SECTPN5001	10	€ 23,79	
		SECTPN5005	10	€ 23,35	
	<p>VASSOIO TRAY ANGOLI STONDATI IMPILABILE B3-PMMA</p> <p>D: 40 x 30 x 3 H cm PESO: 0,588 KG</p> 	SECTPN3001	10	€ 21,58	
		SECTPN3005	10	€ 21,17	

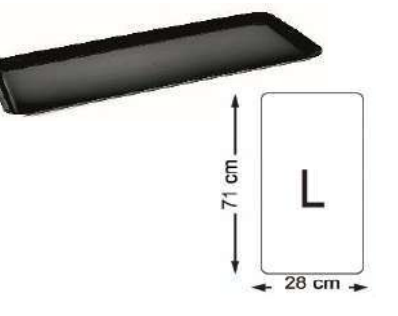

# SISTEMI ESPOSITIVI

IMMAGINE	DESCRIZIONE	CODICE E COLORE	PAG CAT	PREZZO	NOTE
	VASSOIO TRAY ANGOLI STONDATI IMPILABILE C1-PMMA D: 70 x25 x 2,6 H cm 	SECTPM2601	10	€ 50,40	
		SECTPM2605	10	€ 50,40	
 	VASSOIO TRAY ANGOLI STONDATI IMPILABILE C2-PMMA D: 58 x25 x 2,6 H cm 	SECTPC2601	11	€ 35,88	
		SECTPC2605	11	€ 34,12	
	VASSOIO TRAY ANGOLI STONDATI IMPILABILE C2-PMMA D: 58 x25 x 5 H cm 	SECTPC5001	11	€ 36,88	
		SECTPC5005	11	€ 35,12	
	VASSOIO TRAY MODELLO H CON BORDO STONDATO-PMMA D: 57 x38 x 2,6 H cm 	SECTP02605	11	€ 32,34	
	VASSOIO TRAY MODELLO L CON BORDO STONDATO-PMMA D: 71 x 28 x 2,6 H cm 	SECTPL2605	11	€ 57,12	
 	VASSOIO TRAY MODELLO M CON BORDO STONDATO-PMMA D: 81 x 30 x 2,6 H cm 	SECTFM2605	11	€ 69,26	

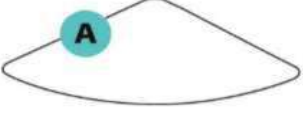
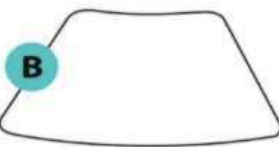
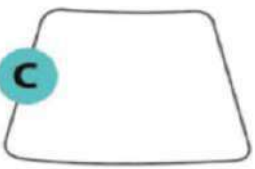

# SISTEMI ESPOSITIVI

IMMAGINE	DESCRIZIONE	CODICE E COLORE	PAG CAT	PREZZO	NOTE
	GRIGLIA MODULARE PER VASSOI D: 38,5 x 24,5 cm	SECTGRTY01	12	€ 3,60	
		SECTGRTY05	12	€ 3,60	
	COPERCHIO CON DOPPIA APERTURA A1 PMMA D: 24 x 22 cm	SECTLDF108	13	€ 19,50	
	COPERCHIO CON DOPPIA APERTURA A2 PMMA D: 36 x 24 cm	SECTLDF208	13	€ 25,60	
	COPERCHIO CON DOPPIA APERTURA A3 PMMA D: 44 x 22 cm	SECTLDF308	13	€ 27,43	
	COPERCHIO CON DOPPIA APERTURA A4 PMMA D: 29,5 x 22 cm	SECTLDC408	13	€ 23,90	
	COPERCHIO CON DOPPIA APERTURA A5 PMMA D: 44 X 29 cm	SECTLDG508	13	€ 32,90	
	COPERCHIO CON DOPPIA APERTURA A6 PMMA D: 22 X 22 cm	SECTLD1608	13	€ 19,00	
	COPERCHIO CON DOPPIA APERTURA A7 PMMA D: 36 X 22 cm	SECTLDD708	13	€ 25,60	
	COPERCHIO CON DOPPIA APERTURA B2 PMMA D: 35 X 26 cm	SECTCPF208	13	€ 25,60	
	COPERCHIO CON DOPPIA APERTURA B3 PMMA D: 40 X 30 cm	SECTCPF308	13	€ 32,90	
	COPERCHIO CON DOPPIA APERTURA C2 PMMA D: 58 x 25 cm	SECTLDG108	13	€ 32,97	

# SISTEMI ESPOSITIVI

IMMAGINE	DESCRIZIONE	CODICE E COLORE	PAG CAT	PREZZO	NOTE
	KIT ANFITEATRO KIT COMPLETO PMMA H 4 cm *ACQUISTABILE SOLO A KIT	SECTPMA105	15	€ 408,00	
	KIT ANFITEATRO COMPONENTE A PMMA D: 27,5 X 27,5 X 4 *NON ACQUISTABILE SEPARATAMENTE	SECTPMAA05	15	X	
	KIT ANFITEATRO COMPONENTE B PMMA D : 16,5 x 25 x 4 cm *NON ACQUISTABILE SEPARATAMENTE	SECTPMBB05	15	X	
	KIT ANFITEATRO COMPONENTE C PMMA D : 15 x 26 x 4 cm *NON ACQUISTABILE SEPARATAMENTE	SECTPMCC05	15	X	
	KIT ANFITEATRO COMPONENTE D PMMA D : 52 X 38 X 4 cm *NON ACQUISTABILE SEPARATAMENTE	SECTPMDD05	15	X	
	KIT ANFITEATRO COMPONENTE E PMMA D : 52 X 38 X 4 cm *NON ACQUISTABILE SEPARATAMENTE	SECTPMEE05	15	X	

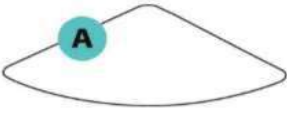
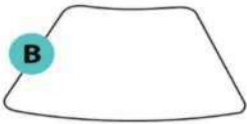
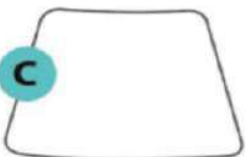
# SISTEMI ESPOSITIVI

IMMAGINE	DESCRIZIONE	CODICE E COLORE	PAG CAT	PREZZO	NOTE
	KIT ANFITEATRO KIT COMPLETO SYMBIOPLEX H 2 cm	SECTCR0205	15	SP	
	KIT ANFITEATRO COMPONENTE A SYMBIOPLEX D: 28 X 28 X 2	SECTYSC505	15	SP	
	KIT ANFITEATRO COMPONENTE B SYMBIOPLEX D : 17 X 28 X 2 cm	SECTYSC105	15	SP	
	KIT ANFITEATRO COMPONENTE C SYMBIOPLEX D : 19 X 28 X 2 cm	SECTYSC305	15	SP	
	KIT ANFITEATRO COMPONENTE D SYMBIOPLEX D : 58 X 35 X 2 cm	SECTYTL105	15	SP	
	KIT ANFITEATRO COMPONENTE E SYMBIOPLEX D : 58 X 35 X 2 cm	SECTYTR105	15	SP	

# SISTEMI ESPOSITIVI







IMMAGINE	DESCRIZIONE	CODICE E COLORE	PAG CAT	PREZZO	NOTE
	CESTO CIRCOLARE CON INSERTO TRASPARENTE 4.5 LT D: Ø 28 cm	SECB150032	17	€ 54,43	
	INSERTO TRASPARENTE 4.5 LT D: Ø 28 cm	SECBCI0108	17	€ 13,48	
	CESTO CIRCOLARE CON INSERTO TRASPARENTE 4.5 LT E COPERCHIO D: Ø 28 cm	SECB160032	17	€ 95,00	
	CESTO RETTANGOLARE PP D: 45 x 32 x 9,5 H cm	SECBC10032	17	€ 50,21	
	VASSOIO TRAY MODELLO A5 CON BORDO STONDATO PMMA D: 44 x 29 x 8,5 H cm	SECTP58501	17	€ 19,71	
		SECTP58505	17	€ 19,35	
	CESTO CON CONTENITORE D: 45 x 32 x 9,5 H cm	SECBC15532	17	€ 69,56	

# SISTEMI ESPOSITIVI







IMMAGINE	DESCRIZIONE	CODICE E COLORE	PAG CAT	PREZZO	NOTE
	CESTO RETTANGOLARE PP D: 37 x 25 x 9,5 H cm	SECBC20032	17	€ 40,19	
	VASSOIO TRAY MODELLO A7 CON BORDO STONDATO PMMA D: 36 x 22 x 8,5 H cm	SECTP78501	17	€ 13,55	
		SECTP78505	17	€ 13,30	
	CESTO CON CONTENITORE D: 37 x 25 x 9,5 H cm	SECBC27532	17	€ 53,49	
	CESTO QUADRATO PP D: 23 x 23 x 9,5 H cm	SECBC30032	17	€ 26,99	
	VASSOIO TRAY MODELLO A6 CON BORDO STONDATO PMMA D: 22 x 22 x 8,5 H cm	SECTP68501	17	€ 9,17	
		SECTP68505	17	€ 9,01	
	CESTO CON CONTENITORE D: 23 x 23 x 9,5 H cm	SECBC36532	17	€ 36,00	



# SISTEMI ESPOSITIVI

IMMAGINE	DESCRIZIONE	CODICE E COLORE	PAG CAT	PREZZO	NOTE
	CESTO QUADRATO SMALL PP D: 29 x 29 x 16 H cm	SECBSQ1632	18	€ 35,24	
	INSERTO QUADRATO DA 4,5 Lt PMMA D: 31,5 X 31,5 X 9 H cm	SECTPY0905	18	€ 32,30	
	CESTO QUADRATO SMALL CON INSERTO DA 4,5 Lt D: 31,5 x 31,5 x 16 H cm	SECBS51632	18	€ 67,54	
	CESTO QUADRATO SMALL PP D: 29 x 29 x 16 H cm	SECBSQ1632	18	€ 35,24	
	INSERTO QUADRATO DA 6,5 Lt PMMA D: 31,5 X 31,5 X 16 H cm	SECTPY1605	18	€ 33,24	
	CESTO QUADRATO SMALL CON INSERTO DA 6,5 Lt D: 31,5 x 31,5 x 16 H cm	SECBS61632	18	€ 68,48	

# SISTEMI ESPOSITIVI

IMMAGINE	DESCRIZIONE	CODICE E COLORE	PAG CAT	PREZZO	NOTE
	CESTO QUADRATO BIG PP D: 29 x 29 x 22 H cm	SECBSQ2232	18	€ 39,66	
	INSERTO QUADRATO DA 4,5 Lt PMMA D: 31,5 X 31,5 X 9 H cm	SECTPY0905	18	€ 32,30	
	CESTO QUADRATO BIG CON INSERTO DA 4,5 Lt D: 31,5 x 31,5 x 22 H cm	SECBS52232	18	€ 71,96	
	CESTO QUADRATO BIG PP D: 29 x 29 x 22 H cm	SECBSQ2232	18	€ 39,66	
	INSERTO QUADRATO DA 6,5 Lt PMMA D: 31,5 X 31,5 X 16 H cm	SECTPY1605	18	€ 33,24	
	CESTO QUADRATO BIG CON INSERTO DA 6,5 Lt D: 31,5 x 31,5 x 22 H cm	SECBS62232	18	€ 72,90	

# SISTEMI ESPOSITIVI

IMMAGINE	DESCRIZIONE	CODICE E COLORE	PAG CAT	PREZZO	NOTE
	CESTO CIRCOLARE SMALL PP D: 32 x 16 H cm	SECB140032	19	€ 38,84	
	INSERTO CIRCOLARE 4,5 Lt PMMA D: 30,5 x 9 H cm	SECTIC4505	19	€ 57,45	
	CESTO CIRCOLARE SMALL CON INSERTO 4,5 Lt D: 32 x 16 H cm	SECB144532	19	€ 96,29	
	CESTO CIRCOLARE SMALL PP D: 32 x 16 H cm	SECB140032	19	€ 38,85	
	INSERTO CIRCOLARE 6,5 Lt PMMA D: 30,5 x 15 H cm	SECTIC6505	19	€ 74,88	
	CESTO CIRCOLARE SMALL CON INSERTO 6,5 Lt D: 32 x 16 H cm	SECB146532	19	€ 113,73	

# SISTEMI ESPOSITIVI

IMMAGINE	DESCRIZIONE	CODICE E COLORE	PAG CAT	PREZZO	NOTE
	CESTO CIRCOLARE BIG PP D: 32 x 22 H cm	SECB210032	19	€ 46,16	
	INSERTO CIRCOLARE 4,5 Lt PMMA D: 30,5 x 9 H cm	SECTIC4505	19	€ 57,45	
	CESTO CIRCOLARE BIG CON INSERTO 4,5 Lt D: 32 x 22 H cm	SECB214532	19	€ 103,61	
	CESTO CIRCOLARE BIG PP D: 32 x 22 H cm	SECB210032	19	€ 46,16	
	INSERTO CIRCOLARE 6,5 Lt PMMA D: 30,5 x 15 H cm	SECTIC6505	19	€ 74,88	
	CESTO CIRCOLARE BIG CON INSERTO 6,5 Lt D: 32 x 22 H cm	SECB216532	19	€ 121,04	

# SISTEMI ESPOSITIVI

IMMAGINE	DESCRIZIONE	CODICE E COLORE	PAG CAT	PREZZO	NOTE
	CESTO QUADRATO IN POLIPROPILENE PIENO Ø 5 mm D: 30 x 30 x 8 H cm	SECBCS0204	20	€ 30,58	
		SECBCS0205	20	€ 30,58	
	CESTO RETTANGOLARE IN POLIPROPILENE PIENO Ø 5 mm D: 30 x 22,5 x 8 H cm	SECBCS0105	20	€ 28,49	
		SECBCS0104	20	€ 28,49	
		SECBCS0117	20	€ 28,49	
	CESTO RETTANGOLARE IN POLIPROPILENE PIENO Ø 5 mm D: 40 x 30 x 10 H cm	SECBCS0304	20	€ 38,21	
		SECBCS0305	20	€ 38,21	
	CESTO RETTANGOLARE IN POLIPROPILENE PIENO Ø 5 mm D: 45 x 30 x 10 H cm	SECBCS0604	20	€ 45,17	
SECBCS0605		20	€ 45,17		
	CESTO RETTANGOLARE IN POLIPROPILENE Ø 5 mm D: 60 x 40 x 12 H cm	SECBCS2004	20	€ 58,45	
		SECBCS2005	20	€ 58,45	
	CESTO RETTANGOLARE IN POLIPROPILENE Ø 5 mm D: 60 x 45 x 10 H cm	SECBCS0904	20	€ 64,63	
		SECBCS0905	20	€ 64,63	
		SECBCS0917	20	€ 64,63	
	CESTO RETTANGOLARE A DUE ALTEZZE IN POLIPROPILENE Ø 5 mm D: 45 x 30 x 6/10 H cm	SECBCS0704	21	€ 42,39	
		SECBCS0705	21	€ 42,39	
	CESTO RETTANGOLARE A DUE ALTEZZE IN POLIPROPILENE Ø 5 mm D: 45 x 60 x 6/12 H cm	SECBCS0804	21	€ 64,63	
		SECBCS0805	21	€ 64,63	



# SISTEMI ESPOSITIVI

IMMAGINE	DESCRIZIONE	CODICE E COLORE	PAG CAT	PREZZO	NOTE	
	CESTO RETTANGOLARE IN POLIPROPILENE Ø 3 mm D: 60 x 45 x 12 H cm	SECBCA0104	21	€ 36,77		
		SECBCA0105	21	€ 36,77		
		SECBCA0117	21	€ 36,77		
	CESTO RETTANGOLARE IN POLIPROPILENE Ø 3 mm D: 45 x 30 x 10 H cm	SECBCA0204	21	€ 17,72		
		SECBCA0205	21	€ 17,72		
		SECBCA0217	21	€ 17,72		
	CESTO RETTANGOLARE IN POLIPROPILENE Ø 3 mm D: 40 x 28 x 8 H cm	SECBCA0304	21	€ 14,37		
		SECBCA0305	21	€ 14,37		
		SECBCA0317	21	€ 14,37		
		CESTO RETTANGOLARE IN POLIPROPILENE Ø 3 mm D: 60 x 30 x 3,5 H cm	SECBCA0704	21	€ 18,05	
			SECBCA0705	21	€ 18,05	
			SECBCA0717	21	€ 18,05	
CESTO RETTANGOLARE IN POLIPROPILENE Ø 3 mm D: 45 x 30 x 3,5 H cm		SECBCA0804	21	€ 13,71		
		SECBCA0805	21	€ 13,71		
		SECBCA0817	21	€ 13,71		
CESTO RETTANGOLARE IN POLIPROPILENE Ø 3 mm D: 40 x 30 x 3,5 H cm		SECBCA0904	21	€ 13,04		
		SECBCA0905	21	€ 13,04		
		SECBCA0917	21	€ 13,04		
CESTO RETTANGOLARE IN POLIPROPILENE Ø 3 mm D: 30 x 25 x 3,5 H cm		SECBCA1004	21	€ 11,36		
		SECBCA1005	21	€ 11,36		
		SECBCA1017	21	€ 11,36		

# SISTEMI ESPOSITIVI

IMMAGINE	DESCRIZIONE	CODICE E COLORE	PAG CAT	PREZZO	NOTE
	VASSOIO IN MELAMINA BIANCO GASTRONORM D: GN 1/1 H 2 cm 53x32,5 cm	SECML92401	22	€ 30,98	
	VASSOIO IN MELAMINA BIANCO GASTRONORM D: GN 1/1 H 6 cm 53x32,5 cm	SECML91901	22	€ 35,63	
	VASSOIO IN MELAMINA BIANCO GASTRONORM D: GN 1/2 H 2 cm 32,5x26,5 cm	SECML92501	22	€ 18,87	
	VASSOIO IN MELAMINA BIANCO GASTRONORM D: GN 1/2 H 6 cm 32,5x26,5 cm	SECML92001	22	€ 20,65	
	VASSOIO IN MELAMINA BIANCO GASTRONORM D: GN 1/3 H 2 cm 32,5x17,6 cm	SECML92301	22	€ 14,88	
	VASSOIO IN MELAMINA BIANCO GASTRONORM D: GN 1/3 H 6 cm 32,5x17,6 cm	SECML92101	22	€ 16,49	
	VASSOIO IN MELAMINA RETTANGOLARE BIANCO D: 30 x 20 x 2 H cm	SECML90801	23	€ 9,31	
	VASSOIO IN MELAMINA RETTANGOLARE BIANCO D: 30 x 20 x 4 H cm	SECML90301	23	€ 10,92	
	VASSOIO IN MELAMINA RETTANGOLARE BIANCO D: 30 x 20 x 8 H cm	SECML90401	23	€ 13,51	
	VASSOIO IN MELAMINA RETTANGOLARE BIANCO D: 40 x 30 x 9 H cm	SECML91201	23	€ 27,23	

# SISTEMI ESPOSITIVI

IMMAGINE	DESCRIZIONE	CODICE E COLORE	PAG CAT	PREZZO	NOTE
	VASSOIO IN MELAMINA RETTANGOLARE BIANCO D: 31 x 31 x 2 H cm	SECML90901	23	€ 14,70	
	VASSOIO IN MELAMINA RETTANGOLARE BIANCO D: 55 x 24 x 2 H cm	SECML90601	23	€ 23,06	
	VASSOIO IN MELAMINA BIANCO GASTRONORM D: GN 1/1 H 2 cm 53x32,5 cm	SECK111201	23	€ 39,10	
	VASSOIO IN MELAMINA BIANCO GASTRONORM D: GN 1/1 H 4 cm 53x32,5 cm	SECK111401	23	€ 46,58	
	VASSOIO IN MELAMINA BIANCO GASTRONORM D: GN 1/1 H 6,5 cm 53x32,5 cm	SECK111601	23	€ 55,08	
	VASSOIO IN MELAMINA BIANCO GASTRONORM D: GN 1/2 H 2 cm 32,5x26,5 cm	SECK112201	23	€ 22,78	
	VASSOIO IN MELAMINA BIANCO GASTRONORM D: GN 1/2 H 6,5 cm 32,5x26,5 cm	SECK112601	23	€ 38,08	
	VASSOIO IN MELAMINA BIANCO GASTRONORM D: GN 1/3 H 2 cm 32,5x17,6 cm	SECK113201	24	€ 18,70	
	VASSOIO IN MELAMINA BIANCO GASTRONORM D: GN 1/3 H 6,5 cm 32,5x17,6 cm	SECK113601	24	€ 28,22	



# SISTEMI ESPOSITIVI

IMMAGINE	DESCRIZIONE	CODICE E COLORE	PAG CAT	PREZZO	NOTE
	VASSOIO IN MELAMINA BIANCO GASTRONORM D: GN 1/4 H 6,5 cm 26,5x16,2 cm	SECK114601	24	€ 23,80	
	VASSOIO IN MELAMINA BIANCO GASTRONORM D: GN 2/4 H 2 cm 53x16,2 cm	SECK124201	24	€ 25,84	
	VASSOIO IN MELAMINA BIANCO GASTRONORM D: GN 2/4 H 6,5 cm 53x16,2 cm	SECK124601	24	€ 43,18	
	VASSOIO IN MELAMINA BIANCO GASTRONORM D: GN 1/6 H 10 cm 17,6x16,2 cm	SECK116001	24	€ 22,78	
	VASSOIO IN MELAMINA GASTRONORM EFFETTO LEGNO D: GN 1/1 53x32,5 cm	SECKL41011	24	€ 55,08	
	VASSOIO IN MELAMINA GASTRONORM EFFETTO LEGNO D: GN 1/2 32,5x26,5 cm	SECKL41012	24	€ 42,84	
	VASSOIO IN MELAMINA GASTRONORM EFFETTO LEGNO D: GN 1/3 32,5x17,6 cm	SECKL41013	24	€ 23,16	
	VASSOIO IN MELAMINA GASTRONORM EFFETTO MARMO D: GN 1/1 53x32,5 cm	SECKM41011	25	€ 55,08	
	VASSOIO IN MELAMINA GASTRONORM EFFETTO MARMO D: GN 1/2 32,5x26,5 cm	SECKM41012	25	€ 42,84	
	VASSOIO IN MELAMINA GASTRONORM EFFETTO MARMO D: GN 1/3 32,5x17,6 cm	SECKM41013	25	€ 23,16	

# SISTEMI ESPOSITIVI

IMMAGINE	DESCRIZIONE	CODICE E COLORE	PAG CAT	PREZZO	NOTE
	TAGLIERE CORTECCIA IN MELAMINA D: 33 x 30 cm	SECKT35033	25	€ 25,50	
	TAGLIERE CORTECCIA IN MELAMINA D:53 x 27 cm	SECKT35053	25	€ 46,24	
	PIATTO OVALE IN MELAMINA NERA D: 49 x 36,5 x 4,4 H cm	SECKM84905	25	€ 45,90	
	PIATTO OVALE IN MELAMINA BIANCA D: 39 x 29 x 4,4 H cm	SECKM83901	25	€ 23,46	
	VASSOIO IN ACRILICO D: 10 x 25 x 1 H cm	SECA102501	26	€ 14,93	
		SECA102505	26	€ 14,93	
		SECA102508	26	€ 14,93	
		SECA102511	26	€ 14,93	

# SISTEMI ESPOSITIVI

IMMAGINE	DESCRIZIONE	CODICE E COLORE	PAG CAT	PREZZO	NOTE
	VASSOIO IN ACRILICO D: 10 x 50 x 1 H cm	SECA105001	26	€ 21,54	
		SECA105005	26	€ 21,54	
		SECA105008	26	€ 21,54	
		SECA105011	26	€ 21,54	
	VASSOIO IN ACRILICO D: 15 x 25 x 1 H cm	SECA152501	26	€ 15,68	
		SECA152505	26	€ 15,68	
		SECA152508	26	€ 15,68	
		SECA152511	26	€ 15,68	
	VASSOIO IN ACRILICO D: 18 x 30 x 1 H cm	SECA183001	27	€ 18,34	
		SECA183005	27	€ 18,34	
		SECA183008	27	€ 18,34	
		SECA183011	27	€ 18,34	
	VASSOIO IN ACRILICO D: 20 x 20 x 1 H cm	SECA202001	27	€ 16,45	
		SECA202005	27	€ 16,45	
		SECA202008	27	€ 16,45	
		SECA202011	27	€ 16,45	



# SISTEMI ESPOSITIVI

IMMAGINE	DESCRIZIONE	CODICE E COLORE	PAG CAT	PREZZO	NOTE
	VASSOIO IN ACRILICO D: 20 x 40 x 1 H cm	SECA204001	27	€ 22,68	
		SECA204005	27	€ 22,68	
		SECA204008	27	€ 22,68	
		SECA204011	27	€ 22,68	
	VASSOIO IN ACRILICO D: 25 x 33 x 1 H cm	SECA253301	27	€ 22,68	
		SECA253305	27	€ 22,68	
		SECA253308	27	€ 22,68	
		SECA253311	27	€ 22,68	
	VASSOIO IN ACRILICO D: 30 x 40 x 1 H cm	SECA304001	27	€ 26,29	
		SECA304005	27	€ 26,29	
		SECA304008	27	€ 26,29	
		SECA304011	27	€ 26,29	
	VASSOIO IN ACRILICO D: 33 x 33 x 1 H cm	SECA333301	28	€ 26,08	
		SECA333305	28	€ 26,08	
		SECA333308	28	€ 26,08	
		SECA333311	28	€ 26,08	

# SISTEMI ESPOSITIVI

IMMAGINE	DESCRIZIONE	CODICE E COLORE	PAG CAT	PREZZO	NOTE
	VASSOIO IN ACRILICO D: 32,5 x 53 x 1 H cm	SECA335301	28	€ 35,53	
		SECA335305	28	€ 35,53	
		SECA335308	28	€ 35,53	
		SECA335311	28	€ 35,53	
	VASSOIO IN ACRILICO D: 20 x 50 x 1 H cm	SECA205001	28	€ 25,52	
		SECA205005	28	€ 25,52	
		SECA205008	28	ND	
		SECA205011	28	ND	
	VASSOIO IN ACRILICO D: 20 x 60 x 1 H cm	SECA206001	28	€ 27,79	
		SECA206005	28	€ 27,79	
		SECA206008	28	ND	
		SECA206011	28	ND	
	VASSOIO IN ACRILICO D: 26,5 x 32,5 x 1 H cm	SECA273301	28	€ 23,62	
		SECA273305	28	€ 23,62	
		SECA273308	28	ND	
		SECA273311	28	ND	

# SISTEMI ESPOSITIVI

IMMAGINE	DESCRIZIONE	CODICE E COLORE	PAG CAT	PREZZO	NOTE
	PIATTO RETTANGOLARE IN ARDESIA GASTRONORM D: 53 x 32,5 cm	SECTVA0605	30	€ 27,36	
	PIATTO RETTANGOLARE IN ARDESIA GASTRONORM D: 32,5 x 26,5 cm	SECTVA0705	30	€ 14,12	
	PIATTO RETTANGOLARE IN ARDESIA GASTRONORM D: 32,5 x 17,5 cm	SECTVA0805	30	€ 9,92	
	PIATTO RETTANGOLARE IN ARDESIA GASTRONORM D: 26,5 x 16,2 cm	SECTVA0905	30	€ 8,20	
	PIATTO RETTANGOLARE IN ARDESIA D: 14 x 8 cm	SECTVA1505	30	€ 3,60	
	PIATTO RETTANGOLARE IN ARDESIA D: 30 x 15 cm	SECTVA1605	30	€ 5,32	
	PIATTO RETTANGOLARE IN ARDESIA D: 30 x 10 cm	SECTVA1705	30	€ 6,34	
	PIATTO RETTANGOLARE IN ARDESIA D: 30 x 20 cm	SECTVA0405	30	€ 14,12	
	PIATTO RETTANGOLARE IN ARDESIA D: 40 x 30 cm	SECTVA0305	30	€ 22,52	

# SISTEMI ESPOSITIVI







IMMAGINE	DESCRIZIONE	CODICE E COLORE	PAG CAT	PREZZO	NOTE
	PIATTO QUADRATO IN ARDESIA D: 30 x 30 cm	SECTVA1105	30	€ 14,31	
	PIATTO QUADRATO IN ARDESIA D: 25 x 25 cm	SECTVA1205	30	€ 10,08	
	PIATTO CIRCOLARE IN ARDESIA Ø 28,5 cm	SECTVA1805	30	€ 14,64	
	PIATTO CIRCOLARE IN ARDESIA Ø 33 cm	SECTVA1905	30	€ 16,85	
	PIATTO QUADRATO IN PORCELLANA EFFETTO ARDESIA OPACA D: 30 x 30 cm	SECTDP0705	31	€ 70,08	
	PIATTO QUADRATO IN PORCELLANA EFFETTO ARDESIA OPACA D: 25 x 25 cm	SECTDP0805	31	€ 62,86	
	PIATTO RETTANGOLARE IN PORCELLANA EFFETTO ARDESIA OPACA D: 32,5 x 17,5 cm	SECTDP1005	31	€ 46,87	
	PIATTO RETTANGOLARE STRIATO IN PORCELLANA EFFETTO ARDESIA OPACA D: 53 x 16 cm	SECTDP1105	31	€ 128,17	
	PIATTO RETTANGOLARE IN PORCELLANA EFFETTO ARDESIA OPACA D: 32 x 26,5 cm	SECTDP0905	31	€ 81,44	

# SISTEMI ESPOSITIVI

IMMAGINE	DESCRIZIONE	CODICE E COLORE	PAG CAT	PREZZO	NOTE
	PIATTO RETTANGOLARE IN MELAMINA EFFETTO ARDESIA NERO OPACO D: 52,4 x 32,3 x 0,9 H cm	SECTBT0205	31	€ 53,60	
	PIATTO RETTANGOLARE IN MELAMINA EFFETTO ARDESIA NERO OPACO D: 32,3 x 17,3 x 0,9 H cm	SECTBT0305	31	€ 21,96	
	PIATTO QUADRATO IN MELAMINA EFFETTO ARDESIA NERO OPACO D: 32,5 x 32,5 x 0,9 H cm	SECTBT0405	32	€ 34,70	
	PIATTO CIRCOLARE IN MELAMINA EFFETTO ARDESIA NERO OPACO D: Ø 33 x 0,9 cm	SECTBT0605	32	€ 32,94	
 <p>*FONDO RIALZATO DI 3 MM</p>	VASSOIO IN COCCIO QUADRATO CON BORDO STONDATO D: 27 x 27 x H5/6 cm 	SECQ27270501	34	€ 26,64	
		SECQ27270505	34	€ 26,64	
		SECQ27270533	34	€ 26,64	
	VASSOIO IN COCCIO QUADRATO CON BORDO STONDATO D: 27 x 27 x H9/10 cm 	SECQ27271001	34	€ 30,39	
		SECQ27271005	34	€ 30,39	
		SECQ27271033	34	€ 30,39	



# SISTEMI ESPOSITIVI

IMMAGINE	DESCRIZIONE	CODICE E COLORE	PAG CAT	PREZZO	NOTE
 <p>*FONDO RIALZATO DI 3 MM</p>	VASSOIO IN COCCIO RETTANGOLARE CON BORDO STONDATO D: 27 x 13,5 x H5/6 cm  	SECR27130501	34	€ 17,12	
		SECR27130505	34	€ 17,12	
		SECR27130533	34	€ 17,12	
	VASSOIO IN COCCIO RETTANGOLARE CON BORDO STONDATO D: 27 x 13,5 x H9/10 cm  	SECR27131001	34	€ 20,97	
		SECR27131005	34	€ 20,97	
		SECR27131033	34	€ 20,97	
	VASSOIO IN COCCIO RETTANGOLARE CON BORDO STONDATO D: 39 x 29 x H5/6 cm  	SECR39290501	34	€ 49,38	
		SECR39290505	34	€ 49,38	
		SECR39290533	34	€ 49,38	
	VASSOIO IN COCCIO RETTANGOLARE CON BORDO STONDATO D: 32 x 24 x H5/6 cm  	SECR32240601	34	€ 46,62	
		SECR32240605	34	€ 51,06	
		SECR32240633	34	€ 42,62	
	VASSOIO IN COCCIO CIRCOLARE CON BORDO VIVO D: Ø 22 x H7/8 cm  	SECC22XX7501	34	€ 19,05	
		SECC22XX7505	34	€ 19,05	
		SECC22XX7533	34	€ 19,05	





# SISTEMI ESPOSITIVI

IMMAGINE	DESCRIZIONE	CODICE E COLORE	PAG CAT	PREZZO	NOTE
	VASSOIO IN COCCIO CIRCOLARE CON BORDO VIVO D: Ø 25 x H8/9 cm	SECC25XX8501	34	€ 24,72	
		SECC25XX8505	34	€ 24,72	
		SECC25XX8533	34	€ 24,72	
	VASSOIO IN COCCIO CIRCOLARE CON BORDO VIVO D: Ø 33 x H10/11 cm	SECC33XX1001	35	€ 39,91	
		SECC33XX1005	35	€ 39,91	
		SECC33XX1033	35	€ 39,91	
  *COPERCHIO INCLUSO	CASSERUOLA CIRCOLARE CON COPERCHIO D: Ø 28 x H11 cm	SECC2811BC33	35	€ 67,23	*PRODOTTO UTILIZZABILE SU FIAMMA
	CASSERUOLA CIRCOLARE CON COPERCHIO D: Ø 25 x H10,5 cm	SECC2510BC33	35	€ 47,19	*PRODOTTO UTILIZZABILE SU FIAMMA
	TEGAME CIRCOLARE BOMBATO SENZA COPERCHIO D: Ø 28 x H7,5 cm	SECB2875BC04	35	€ 29,32	*PRODOTTO UTILIZZABILE SU FIAMMA
	COPERCHIO CIRCOLARE PER TEGAME BOMBATO	SECP2800BC04	35	€ 16,51	*PRODOTTO UTILIZZABILE SU FIAMMA

# SISTEMI ESPOSITIVI

IMMAGINE	DESCRIZIONE	CODICE E COLORE	PAG CAT	PREZZO	NOTE
 <p>*CHIEDERE INFO PER VASCHEE IN PC E PE</p>	VASCHEE SERIE GN 1/1 IN STS D: 53 x 32,5 x H 6,5 cm	AVBCG10112	36	€ 52,24	
	VASCHEE SERIE GN 1/1 IN STS D: 53 x 32,5 x H 10 cm	AVBCG10212	36	€ 60,29	
	VASCHEE SERIE GN 1/1 IN STS D: 53 x 32,5 x H 15 cm	AVBCG10312	36	€ 88,11	
	VASCHEE SERIE GN 1/1 IN STS D: 53 x 32,5 x H 20 cm	AVBCG10412	36	€ 109,13	
	VASCHEE SERIE GN 1/2 IN STS D: 32,5 x 26,5 x2 H 6,5 cm	AVBCG10512	36	€ 32,07	
	VASCHEE SERIE GN 1/2 IN STS D: 32,5 x 26,5 x2 H 10 cm	AVBCG10612	36	€ 39,06	
	VASCHEE SERIE GN 1/2 IN STS D: 32,5 x 26,5 x2 H 15 cm	AVBCG10712	36	€ 51,40	
	VASCHEE SERIE GN 1/2 IN STS D: 32,5 x 26,5 x2 H 20 cm	AVBCG10812	36	€ 64,13	
	VASCHEE SERIE GN 1/3 IN STS D: 32,5 x 17,5 x H 6,5 cm	AVBCG10912	36	€ 22,73	
	VASCHEE SERIE GN 1/3 IN STS D: 32,5 x 17,5 x H 10 cm	AVBCG11012	36	€ 28,47	
	VASCHEE SERIE GN 1/3 IN STS D: 32,5 x 17,5 x H 15 cm	AVBCG11112	36	€ 43,30	
	VASCHEE SERIE GN 1/3 IN STS D: 32,5 x 17,5 x H 20 cm	AVBCG11212	36	€ 49,70	
	VASCHEE SERIE GN 1/4 IN STS D: 26,5 x 16,2 x H 6,5 cm	AVBCG11312	36	€ 21,23	
	VASCHEE SERIE GN 1/4 IN STS D: 26,5 x 16,2 x H 10 cm	AVBCG11412	36	€ 24,62	
	VASCHEE SERIE GN 1/4 IN STS D: 26,5 x 16,2 x H 15 cm	AVBCG11512	36	€ 34,81	
	VASCHEE SERIE GN 1/4 IN STS D: 26,5 x 16,2 x H 20 cm	AVBCG11612	36	€ 46,70	

# SISTEMI ESPOSITIVI

IMMAGINE	DESCRIZIONE	CODICE E COLORE	PAG CAT	PREZZO	NOTE
 <p>*COPERCHI SENZA GUARNIZIONI</p>	COPERCHIO PER VASCHETTE SERIE GASTRONORM IN STS D: 1/1	AVBCG11712	36	€ 34,62	*SP COPERCHI CON GUARNIZIONI
	COPERCHIO PER VASCHETTE SERIE GASTRONORM IN STS D: 1/2	AVBCG11812	36	€ 21,43	
	COPERCHIO PER VASCHETTE SERIE GASTRONORM IN STS D: 1/3	AVBCG11912	36	€ 17,84	
	COPERCHIO PER VASCHETTE SERIE GASTRONORM IN STS D: 1/4	AVBCG12012	36	€ 14,45	
	TAGLIERE ROTONDO IN LEGNO D: Ø 25 x 1,5 cm	SECTWD2534	38	€ 14,77	
	TAGLIERE ROTONDO IN LEGNO ACACIA D: Ø 30 x 1,5 cm	SECTWD3034	38	€ 12,24	
	TAGLIERE ROTONDO IN LEGNO D: Ø 30 X 2 cm	SECTWD3035	38	€ 16,69	*FOTO SOLO INDICATIVA
	TAGLIERE RETTANGOLARE IN LEGNO D: 81 x 32 cm	SECTWD8134	38	€ 120,37	

# SISTEMI ESPOSITIVI

IMMAGINE	DESCRIZIONE	CODICE E COLORE	PAG CAT	PREZZO	NOTE
	TAGLIERE IN LEGNO D: 45 x 20 x 1,5 cm TOLLERANZA 5 CM	SECTCT45	38	€ 30,73	
	TAGLIERE IN LEGNO D: 55 x 22 x 1,5 cm TOLLERANZA 5 CM	SECTCT55	38	€ 39,16	
	TAGLIERE IN LEGNO D: 65 x 23 x 1,8 cm TOLLERANZA 5 CM	SECTCT65	38	€ 59,18	
	TAGLIERE IN LEGNO D: 75 x 26 x 1,8 cm TOLLERANZA 5 CM	SECTCT75	38	€ 71,36	
	TAGLIERE CORTECCIA CIRCOLARE Dmax: ø 28 x 2,5 H cm TOLLERANZA 5 CM	SECTCT40	38	€ 20,65	
	MORSA PER PROSCIUTTO IN LEGNO	SECTMP0534	39	€ 286,65	
	MORSA ECONOMICA PER PROSCIUTTO IN FERRO	AVMPLCFE	FC	€ 52,50	
	CULLA PORTA FORMAGGIO IN LEGNO NATURALE MULTISTRATO D: 20 x 14 x 7h cm	SECTCU2034	39	€ 28,64	



# SISTEMI ESPOSITIVI

IMMAGINE	DESCRIZIONE	CODICE E COLORE	PAG CAT	PREZZO	NOTE
 <p>*PERSONALIZZABILI NELLE MISURE O CON STAMPE E INCISIONI</p>	CASSETTA IN MULTISTRATO DI FAGGIO D: 27 x 27 x 10 H cm	SECTCS0134	39	€ 79,59	
	CASSETTA IN MULTISTRATO DI FAGGIO D: 27 x 27 x 15 H cm	SECTCS0234	39	€ 86,61	
	CASSETTA IN MULTISTRATO DI FAGGIO D: 30 x 20 x 10 H cm	SECTCS0334	39	€ 77,28	
	CASSETTA IN MULTISTRATO DI FAGGIO D: 30 x 20 x 15 H cm	SECTCS0434	39	€ 83,94	
	CASSETTA IN MULTISTRATO DI FAGGIO D: 32 x 26 x 10 H cm	SECTCS0534	39	€ 81,57	
	CASSETTA IN MULTISTRATO DI FAGGIO D: 32 x 26 x 15 H cm	SECTCS0634	39	€ 88,96	
	CASSETTA IN MULTISTRATO DI FAGGIO D: 32 x 27 x 10 H cm	SECTCS3234	39	€ 82,15	
	CASSETTA IN MULTISTRATO DI FAGGIO D: 40 x 30 x 10 H cm	SECTCS0734	39	€ 88,26	
	CASSETTA IN MULTISTRATO DI FAGGIO D: 40 x 30 x 15 H cm	SECTCS0834	39	€ 96,73	
	CASSETTA IN MULTISTRATO DI FAGGIO D: 53 x 32 x 10 H cm	SECTCS5334	39	€ 97,05	

# SISTEMI ESPOSITIVI

IMMAGINE	DESCRIZIONE	CODICE E COLORE	PAG CAT	PREZZO	NOTE
	CASSETTE A PARETI ABBATTIBILI EFFETTO LEGNO IN RPC D: 40 x 30 x 16 H cm	SECSP41634	40		
	CASSETTE A PARETI ABBATTIBILI EFFETTO LEGNO IN RPC D: 60 x 40 x 11 H cm	SECSP61134	40		
	CASSETTE A PARETI ABBATTIBILI EFFETTO LEGNO IN RPC D: 60 x 40 x 16 H cm	SECSP61634	40	€ 19,14	
	CASSETTE A PARETI ABBATTIBILI EFFETTO LEGNO IN RPC D: 60 x 40 x 19 H cm	SECSP61934	40	€ 20,23	
	CASSETTE A PARETI ABBATTIBILI EFFETTO LEGNO IN RPC D: 60 x 40 x 22 H cm	SECSP62234	40	€ 22,10	
	PORTA PIZZA CON MANIGLIA IN LAMINATO EFFETTO LEGNO D: 73 x 30 x 0,6 H cm	SECTWD8234	40	€ 118,12	
	PORTA PIZZA CON MANIGLIA IN LAMINATO EFFETTO LEGNO SCURO D: 71 x 30 x 0,6 H cm	SECTWD8334	40	€ 96,08	
	TAGLIERE IN LAMINATO PLASTICO EFFETTO LEGNO SCURO D: 30 x 20 x 0,6 H cm	SECTWD8534	40	€ 39,38	
	TAGLIERE IN LAMINATO PLASTICO EFFETTO LEGNO SCURO D: 40 x 30 x 0,6 H cm	SECTWD8634	40	€ 67,72	
	TAGLIERE IN LAMINATO PLASTICO EFFETTO LEGNO SCURO D: 62 x 30 x 0,6 H cm	SECTWD8434	40	SP	

# SISTEMI ESPOSITIVI





IMMAGINE	DESCRIZIONE	CODICE E COLORE	PAG CAT	PREZZO	NOTE
	VASSOIO CIRCOLARE PMMA D: Ø 26 cm	SECTPX26W1	40	€ 19,60	
	VASSOIO CIRCOLARE PMMA D: Ø 26 cm	SECTPX26W2	40	€ 19,60	
	VASSOIO CIRCOLARE PMMA D: Ø 26 cm	SECTPX26W3	40	€ 19,60	
	VASSOIO CIRCOLARE PMMA D: Ø 26 cm	SECTPX26W4	40	€ 19,60	
	CONTENITORE A BARILE IN LEGNO 10LT CON COPERCHIO D: Ø 33 cm x 25 H cm	SECTWD1004	41	€ 130,62	
	CONTENITORE A BARILE IN LEGNO 10LT SENZA COPERCHIO D: Ø 33 cm x 25 H cm	SECTSC1004	41	€ 90,54	
	CONTENITORE A BARILE IN LEGNO 20LT CON COPERCHIO D: Ø 38 cm x 35 H cm	SECTWD2004	41	€ 141,39	
	CONTENITORE A BARILE IN LEGNO 20LT SENZA COPERCHIO D: Ø 38 cm x 35 H cm	SECTSC2004	41	€ 96,21	
	SACCO JUTA PER CONTENITORE 10LT D: Ø 33 cm	SECTJB3434	41	€ 11,90	



# SISTEMI ESPOSITIVI

IMMAGINE	DESCRIZIONE	CODICE E COLORE	PAG CAT	PREZZO	NOTE
 	<p>SACCO JUTA PER CONTENITORE 20LT D: Ø 38 cm</p>	SECTJB3834	41	€ 17,96	
	<p>COPERCHIO CON ASOLA PER CONTENITORE 10LT D: Ø 33 cm</p>	SECTCB1008	42	€ 40,08	
	<p>COPERCHIO SENZA ASOLA PER CONTENITORE 10LT D: Ø 33 cm</p>	SECTCB5108	42	€ 40,08	
	<p>COPERCHIO CON ASOLA PER CONTENITORE 20LT D: Ø 38 cm</p>	SECTCB2008	42	€ 45,19	
	<p>COPERCHIO SENZA ASOLA PER CONTENITORE 20LT D: Ø 38 cm</p>	SECTCB5208	42	€ 45,19	
 	<p>INSERTO PER CONTENITORE 10LT D: Ø 33 x 18 H cm</p>	SECTIC1005	42	SP	
 	<p>INSERTO PER CONTENITORE 20LT D: Ø 38 x 23 H cm</p>	SECTIC2008	42	SP	

# SISTEMI ESPOSITIVI

IMMAGINE	DESCRIZIONE	CODICE E COLORE	PAG CAT	PREZZO	NOTE
	CONTENITORE A BARILE SENZA INSERTO Ø30CM D: Ø 30,7 x 19,5 H cm	FC-CON0122199	FC	€ 115,00	
	CONTENITORE A BARILE CON INSERTO IN MELAMINA CAPACITÀ 4,5 LT D: Ø 30,7 x 19,5 H cm	SECTS35004	42	€ 170,66	
	CONTENITORE A BARILE CON INSERTO IN MELAMINA CAPACITÀ 6,5 LT D: Ø 30,7 x 19,5 H cm	SECTS36004	42	€ 191,38	
	CONTENITORE A BARILE CON INSERTO IN PMMA CAPACITÀ 4,5 LT D: Ø 30,7 x 19,5 H cm	SECTS36005/P	FC	€ 31,80	
	COPERCHIO PER IL CONTENITORE A BARILE IN ACR D: Ø 30 cm	SECTL35008	42	€ 27,65	
	CONTENITORE A MEZZALUNA CAPACITÀ 0,9 LT	SECT568001 SECT568005	CAT 2017	€ 54,25	
	CONTENITORE A MEZZALUNA CAPACITÀ 3 LT	SECT563001 SECT563005	CAT 2017	€ 110,33	
	CONTENITORE A MEZZALUNA CAPACITÀ 5 LT	SECT563101 SECT563105	CAT 2017	€ 151,09	

# SISTEMI ESPOSITIVI

IMMAGINE	DESCRIZIONE	CODICE E COLORE	PAG CAT	PREZZO	NOTE
	PIEDISTALLO CIRCOLARE PER CONTENITORI A MEZZALUNA	SECTB11801 SECTB11805	CAT 2017	€ 56,14	
	VASSOIO GASTRONORM IN PP MISURE ESTERNE: 53 x 32,5 cm MISURE INTERNE: 47 x 28 cm	SECTFF5305	43	€ 14,78	CF 20 PZ
		SECTFF5306	43	€ 14,78	
	VASSOIO FAST FOOD IN PP MISURE ESTERNE: 41,5 x 30,5 cm MISURE INTERNE: 37,5 x 26,7 cm	SECTFF4105	43	€ 7,10	CF 50 PZ
		SECTFF4106	43	€ 7,10	
	ALZATA QUADRATA A CROCE PMMA D : 15 x 5 H cm	SECBRX0501	45	€ 12,53	
		SECBRX0505	45	€ 12,53	
		SECBRX0508	45	€ 12,53	
	ALZATA QUADRATA A CROCE PMMA D: 15 x 10 H cm	SECBRX1001	45	€ 15,13	
		SECBRX1005	45	€ 15,13	
		SECBRX1008	45	€ 15,13	
	ALZATA QUADRATA A CROCE PMMA D: 15 x 15 H cm	SECBRX1501	45	€ 16,08	
		SECBRX1505	45	€ 16,08	
		SECBRX1508	45	€ 16,08	

# SISTEMI ESPOSITIVI

IMMAGINE	DESCRIZIONE	CODICE E COLORE	PAG CAT	PREZZO	NOTE
	ALZATA CIRCOLARE COMPOSTA DA 1 PIATTO PORTANTE E 4 ANELLI SOVRAPPONIBILI D: 22 x 13,5 cm	SECBRC0108	CAT 2017	€ 16,02	
	PIATTO PER ALZATA CIRCOLARE D: 22 x 3 cm	SECBRC0208	CAT 2017	SP	
	ANELLO PER ALZATA CIRCOLARE D: 9,7 x 3 cm	SECBRC0308	CAT 2017	SP	
	BASE PER ALZATA CIRCOLARE D: Ø 9,3 cm	SECBRC0408	CAT 2017	SP	
	ESPOSITORE INCLINATO PMMA D: 28 x 20 x 11,5 H cm	SECBEXP101	FC	€ 17,39	
		SECBEXP105	FC	€ 17,39	
		SECBEXP108	FC	€ 17,39	
	ESPOSITORE INCLINATO PMMA D: 28 x 20 x 11,5 H cm	SECBEST101	45	€ 13,15	
		SECBEST105	45	€ 13,15	
		SECBEST108	45	€ 13,15	
	PORTAPANINI IN PMMA D: 15 x 55 x 4 H cm	SECBPN1501	45	€ 33,08	
		SECBPN1505	45	€ 33,08	
	ESPOSITORE DA BANCO IN PVC NERO CON BASE MAGNETICA D: 15,2 x 14 H cm	SECBSP1505	45	€ 6,20	

# SISTEMI ESPOSITIVI

IMMAGINE	DESCRIZIONE	CODICE E COLORE	PAG CAT	PREZZO	NOTE
	ALZATA DA BANCO PS D: 81 x 40 X 7,5 H cm	SECBAZ0201	45	€ 59,50	
		SECBAZ0205	45	€ 59,50	
	ALZATA DA BANCO PS D: 54 x 44 X 8 H cm	SECBAZ0101	45	€ 56,00	
		SECBAZ0105	45	€ 56,00	
	GRIGLIA PORTA RICOTTA PER VASSOIO A3 H35 IN PLEXI 5MM	SECBGA3301	46	SP	*REALIZZABILI PER I FORMATI
		SECBGA3305	46	SP	
		SECBGA3308	46	SP	
	ALZATA DA BANCO 3 PIANI CON PIEGA LATO CORTO PMMA Dimensioni 1: 40x25x8H cm Dimensioni 2: 38,5x25x5H cm Dimensioni 3: 37x25x3H cm MISURE PERSONALIZZABILI	SECBAR0301	46	€ 114,45	
		SECBAR0305	46	€ 114,45	
		SECBAR0308	46	€ 114,45	
	ALZATA DA BANCO 3 PIANI CON PIEGA LATO LUNGO PMMA Dimensioni 1: 40 x 25 x 8 H cm Dimensioni 2: 40 x 25 x 5 H cm Dimensioni 3: 40 x 25 x 3 H cm MISURE PERSONALIZZABILI	SECBAS0301	46	€ 129,36	
		SECBAS0305	46	€ 129,36	
		SECBAS0308	46	€ 129,36	



# SISTEMI ESPOSITIVI

IMMAGINE	DESCRIZIONE	CODICE E COLORE	PAG CAT	PREZZO	NOTE
	<b>ALZATA DA BANCO 3 PIANI CON PIEGA LATO LUNGO PMMA</b> Dimensioni 1: 40 x 25 x 8 H cm Dimensioni 2: 40 x 25 x 5 H cm Dimensioni 3: 40 x 25 x 3 H cm MISURE PERSONALIZZABILI	SECBAW0355	46	€ 165,90	
		SECBAW0360	46	€ 165,90	
		SECBAW0356	46	€ 165,90	
	<b>ALZATA DA BANCO 3 PIANI IN PMMA FINITURA LUCIDA</b> D: 80 x 80 cm	SECBAW0355	47	€ 269,80	
	<b>ALZATA DA BANCO 3 PIANI IN FOREX FINITURA OPACA</b> D: 80 x 80 cm	SECBAF9005	47	€ 173,20	
	<b>VETRINA PROTETTIVA PMMA</b> D: 22 / 17 x 45 X 20 H cm	SECBVPX108	48	€ 88,75	
	<b>VETRINA PROTETTIVA PMMA</b> D: 22 / 17 x 60 x 20 Hcm	SECBVPC208	48	€ 94,94	
	<b>VETRINA PROTETTIVA PMMA</b> D: 22 / 17 x 80 X 20 H cm	SECBVPD308	48	€ 136,00	
	<b>VETRINA PROTETTIVA PMMA</b> D: 26 x 44 X 20 H cm	SECBVT4408	48	€ 132,49	
	<b>VETRINA PROTETTIVA PMMA</b> D: 26 x 65 x 20 H cm	SECBVT6408	48	€ 170,93	
	<b>VETRINA PROTETTIVA PMMA</b> D: 26 x 86 X 20 H cm	SECBVT8608	48	€ 209,35	

# SISTEMI ESPOSITIVI



IMMAGINE	DESCRIZIONE	CODICE E COLORE	PAG CAT	PREZZO	NOTE
	VETRINA PROTETTIVA PMMA D: 27 x 44 X 33 H cm	SECBV24408	48	€ 210,94	
	VETRINA PROTETTIVA PMMA D: 27 x 65 x 33 H cm	SECBV26408	48	€ 255,10	
	VETRINA PROTETTIVA PMMA D: 27 x 86 X 33 H cm	SECBV28608	48	€ 290,84	
	ALZATA VETRO CON PIATTO E CAMPANA D: ø 32 x 28 H cm	SECB661208	49	€ 35,00	
	PIATTO TORTA IN VETRO CON CAMPANA D: ø 32 cm	SECB088308	49	€ 31,12	
	PORTA CIAMBELLONE IN POLICARBONATO D: ø 30,5 cm	SECBPC3008	49	€ 26,25	
	PORTA CIAMBELLONE IN POLICARBONATO D: ø 35,5 cm	SECBPC3508	49	€ 27,54	
	CIOTOLA TRASPARENTE IN POLICARBONATO D: ø 28 cm	SECBCIO108	49	€ 13,48	
	CIOTOLA TRASPARENTE IN POLICARBONATO D: ø 32,5 cm	SECBCIO208	49	€ 19,70	
	CIOTOLA TRASPARENTE IN POLICARBONATO D: ø 38 cm	SECBCIO308	49	€ 29,68	
	COPERCHIO CON ASOLA PER CIOTOLA TRASPARENTE IN POLICARBONATO D: ø 38 cm	SECTCB2008	49	€ 45,19	
	COPERCHIO SENZA ASOLA PER CIOTOLA TRASPARENTE IN POLICARBONATO D: ø 38 cm	SECTCB5208	49	€ 45,19	

# SISTEMI ESPOSITIVI



IMMAGINE	DESCRIZIONE	CODICE E COLORE	PAG CAT	PREZZO	NOTE
	TORRE PER VASSOI PASTICCERIA IN PMMA D: 40 x 30 x 60 H cm	SECBTR5808	49	SP	
	TORRE PER VASSOI PASTICCERIA IN ACCIAIO INOX LUCIDO D: 40 x 30 x 60 H cm	SECBTR5831	49	€ 253,26	
	PORTA FORMAGGIO QUADRATO IN MELAMINA+PS D: 31 x 28 x 12 H cm	SECBF43608	49	€ 35,00	
	PORTA FORMAGGIO RETTANGOLARE IN MELAMINA+PS D: 30,5 x 18 x 8 H cm	SECBF43508	49	€ 23,35	
	DIVISORI INCOLLATI 5 MM PMMA D: 80 x 20 H cm	SEDV582008	51	€ 73,59	
	DIVISORI INCOLLATI 5 MM PMMA D: 80 x 12 H cm	SEDV581208	51	€ 60,27	
	DIVISORI INCOLLATI 5 MM PMMA D: 40 x 20 H cm	SEDV542008	51	€ 48,29	



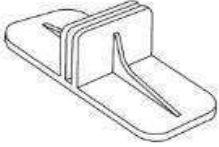

# SISTEMI ESPOSITIVI

IMMAGINE	DESCRIZIONE	CODICE E COLORE	PAG CAT	PREZZO	NOTE
 <p>*PIEDINI INCLUSI</p>	DIVISORI CON PIEDINI AD INCASTRO 3MM PMMA+PC D: 60 x 15 H cm	SEDVR61508	51	€ 22,65	
	DIVISORI CON PIEDINI AD INCASTRO 3MM PMMA+PC D: 70 x 15 H cm	SEDVR71508	51	€ 25,64	
	DIVISORI CON PIEDINI AD INCASTRO 3MM PMMA+PC D: 80 x 15 H cm	SEDVR81508	51	€ 28,31	
	DIVISORI CON PIEDINI AD INCASTRO 3MM PMMA+PC D: 60 x 30 H cm	SEDVR63008	51	€ 31,97	
	DIVISORI CON PIEDINI AD INCASTRO 3MM PMMA+PC D: 70 x 30 H cm	SEDVR73008	51	€ 35,63	
	DIVISORI CON PIEDINI AD INCASTRO 3MM PMMA+PC D: 80 x 30 H cm	SEDVR83008	51	€ 39,30	
	DIVISORI CON PIEDINI AD INCASTRO 5MM PMMA+PC D: 60 x 15 H cm	SEDV561508	51	€ 29,97	
	DIVISORI CON PIEDINI AD INCASTRO 5MM PMMA+PC D: 70 x 15 H cm	SEDV571508	51	€ 33,30	
	DIVISORI CON PIEDINI AD INCASTRO 5MM PMMA+PC D: 80 x 15 H cm	SEDV581508	51	€ 36,63	
	DIVISORI CON PIEDINI AD INCASTRO 5MM PMMA+PC D: 60 x 30 H cm	SEDV563008	51	€ 43,63	
	DIVISORI CON PIEDINI AD INCASTRO 5MM PMMA+PC D: 70 x 30 H cm	SEDV573008	51	€ 49,29	
	DIVISORI CON PIEDINI AD INCASTRO 5MM PMMA+PC D: 80 x 30 H cm	SEDV583008	51	€ 54,95	



# SISTEMI ESPOSITIVI

IMMAGINE	DESCRIZIONE	CODICE E COLORE	PAG CAT	PREZZO	NOTE
	PIEDE PER DIVISORE 3MM IN PC D: 10 x 4 x 27 H cm	SEDVHDR108	51	€ 1,50	
	PIEDE PER DIVISORE 5MM IN PC D: 10 x 4 x 27 H cm	SEDVHDR108/5	51	€ 1,50	
	DIVISORI STAMPATI AD INCASTRO 3MM PMMA+PC D: 60 x 15 H cm	SEDVR615XX	52	€ 26,98	
	DIVISORI STAMPATI AD INCASTRO 5MM PMMA+PC D: 60 x 15 H cm	SEDV5615XX	52	€ 34,30	
	DIVISORI STAMPATI AD INCASTRO 3MM PMMA+PC D: 70 x 15 H cm	SEDVR715XX	52	€ 30,31	
	DIVISORI STAMPATI AD INCASTRO 5MM PMMA+PC D: 70 x 15 H cm	SEDV5715XX	52	€ 38,30	
	DIVISORI STAMPATI AD INCASTRO 3MM PMMA+PC D: 80 x 15 H cm	SEDVR815XX	52	€ 33,97	
	DIVISORI STAMPATI AD INCASTRO 5MM PMMA+PC D: 80 x 15 H cm	SEDV5815XX	52	€ 42,29	
	DIVISORI STAMPATI AD INCASTRO 3MM PMMA+PC D: 60 x 30 H cm	SEDVR630XX	52	€ 40,30	
	DIVISORI STAMPATI AD INCASTRO 5MM PMMA+PC D: 60 x 30 H cm	SEDV5815XX	52	€ 51,62	
	DIVISORI STAMPATI AD INCASTRO 3MM PMMA+PC D: 70 x 30 H cm	SEDVR730XX	53	€ 45,29	
	DIVISORI STAMPATI AD INCASTRO 5MM PMMA+PC D: 70 x 30 H cm	SEDV5730XX	53	€ 58,94	

# SISTEMI ESPOSITIVI

IMMAGINE	DESCRIZIONE	CODICE E COLORE	PAG CAT	PREZZO	NOTE
	DIVISORI STAMPATI AD INCASTRO 3MM PMMA+PC D: 80 x 30 H cm	SEDVR830XX	53	€ 50,29	
	DIVISORI STAMPATI AD INCASTRO 5MM PMMA+PC D: 80 x 30 H cm	SEDV5830XX	53	€ 65,94	
 <p>*MANICI CHIUSI</p>	CASSETTA IMPILABILE 60x40 IN MOPLEN D: 60 x 40 x 7 cm	SECSMP0701	55	€ 15,16	
	CASSETTA IMPILABILE 60x40 IN MOPLEN D: 60 x 40 x 10 cm	SECSMP1001	55	€ 16,69	
	CASSETTA IMPILABILE 60x40 IN MOPLEN D: 60 x 40 x 13 cm	SECSMP1301	55	€ 27,65	
	CASSETTA IMPILABILE 60x40 IN MOPLEN D: 60 x 40 x 17 cm	SECSMP1701	55	€ 32,37	
	CASSETTA IMPILABILE 60x40 IN MOPLEN D: 60 x 40 x 20 cm	SECSMP2001	55	SP	
	CASSETTA IMPILABILE 60x40 IN MOPLEN D: 60 x 40 x 22 cm	SECSMP2201	55	€ 38,32	
	CASSETTA IMPILABILE 60x40 IN MOPLEN D: 60 x 40 x 32 cm	SECSMP3201	55	€ 50,05	
 <p>*MANICI CHIUSI</p>	CASSETTA IMPILABILE 40x30 IN MOPLEN D: 40 x 30 x 10 cm	SECSMS1001	55	€ 15,36	
	CASSETTA IMPILABILE 40x30 IN MOPLEN D: 40 x 30 x 13 cm	SECSMS1301	55	€ 13,65	
	CASSETTA IMPILABILE 40x30 IN MOPLEN D: 40 x 30 x 17 cm	SECSMS1701	55	€ 16,10	
	CASSETTA IMPILABILE 40x30 IN MOPLEN D: 40 x 30 x 22 cm	SECSMS2201	55	€ 19,08	
	CASSETTA IMPILABILE 40x30 IN MOPLEN D: 40 x 30 x 32 cm	SECSMS3201	55	€ 25,55	

# SISTEMI ESPOSITIVI

IMMAGINE	DESCRIZIONE	CODICE E COLORE	PAG CAT	PREZZO	NOTE
 <p>COPERCHI Covers</p>	COPERCHIO PER CASSETTE IMPILABILI IN MOPLEN D: 60 x 40 cm	SECP604001	55	€ 13,12	
	COPERCHIO PER CASSETTE IMPILABILI IN MOPLEN D: 40 x 30 cm	SECP403001	55	€ 9,62	
	COPERCHIO PER CASSETTE IMPILABILI IN MOPLEN CON GANCIO D: 40 x 30 cm	SECP403001-G	55	€ 10,85	
	CASSETTA IMPILABILE FORATA IN MOPLEN D: 60 x 40 x 7 cm	SECFMP0701	55	€ 15,93	
	CASSETTA IMPILABILE FORATA IN MOPLEN D: 60 x 40 x 10 cm	SECFMP1001	55	€ 18,83	
	CASSETTA IMPILABILE FORATA IN MOPLEN D: 60 x 40 x 13 cm	SECFMP1301	55	€ 21,88	
	CASSETTA 65LT PIENA - IMPILABILI E SOVRAPPONIBILE-IN MOPLEN D: 63 x 44 x 34 H cm	SECSMP3401	56	€ 30,10	
	CASSETTA 90LT PIENA - IMPILABILI E SOVRAPPONIBILE-IN MOPLEN D: 72 x 47x 36 H cm	SECSMP3601	56	€ 43,33	
	COPERCHIO PER CASSETTA 65LT PIENA IN MOPLEN D: 63 x 44 x 34 H cm	SECP634401	56	€ 11,31	
	COPERCHIO PER CASSETTA 90LT PIENA IN MOPLEN D: 72 x 47x 36 H cm	SECP724701	56	€ 16,45	

# SISTEMI ESPOSITIVI

IMMAGINE	DESCRIZIONE	CODICE E COLORE	PAG CAT	PREZZO	NOTE
	CASSETTA A PARETE FORATA - IMPILABILE E SOVRAPPONIBILE-IN MOPLN D: 63 x 44 x 34 H cm	SECFMP4001	56	€ 25,02	
	CUCCHIAIO IN SAN L:23,5 cm	SEC BSP0105	58	€ 5,40	
	CUCCHIAIO PER ANTIPASTI IN SAN L: 26 cm	SEC BSP0205	58	€ 4,33	
	PALETTA IN SAN L :25 cm	SEC BSP0305	58	€ 8,80	
	PALETTA IN SAN L :31 cm	SEC BSP0405	58	€ 11,80	
	PINZA IN SAN L:24 cm	SEC BSP01205	58	€ 20,64	

# SISTEMI ESPOSITIVI

IMMAGINE	DESCRIZIONE	CODICE E COLORE	PAG CAT	PREZZO	NOTE
	PINZA PER SPAGHETTI IN STS L: 16 cm	SECBL10331	58	€ 9,40	
	PINZA PER IL PANE IN STS L: 23 cm	SECBL10431	58	€ 9,47	
	PINZA PER PASTICCERIA CON LAMA SEGHETTATA IN STS L: 29,5 cm	SECBPM3731	58	€ 30,90	
	SCHIUMAROLA IN STS L: 38,5 cm	SECB251131	58	€ 12,60	
	PINZA PER SERVIRE IN STS L: 24 cm	SECBL10531	58	€ 22,96	

# SISTEMI ESPOSITIVI



IMMAGINE	DESCRIZIONE	CODICE E COLORE	PAG CAT	PREZZO	NOTE
	CUCCHIAIO PER SOTTOLOIO E SPAGHETTI IN STS L: 32,5 cm	SECB167331	58	€ 9,47	
	PINZA PER CARNI E VEGETALI IN STS L: 23,5 cm	SECBL30931	59	€ 5,50	
	CUCCHIAIONE IN STS L: 48 cm	SECBM25631	59	€ 25,60	
	MESTOLO Ø 90 MM IN STS L: 36 cm	SECB500931	59	€ 9,60	
	PINZA PER AFFETTATI IN STS L: 10 cm	SECBL11931	59	€ 7,42	

# SISTEMI ESPOSITIVI





IMMAGINE	DESCRIZIONE	CODICE E COLORE	PAG CAT	PREZZO	NOTE
	PINZA PER SOTTOLIO E SOTTACETO IN STS L: 21,5 cm	SECB811931	59	€ 17,29	
	CUCCHIAIONE MULTIUSO FORATO IN STS L: 30 cm	SECB102F31	59	€ 18,20	
	PALETTA PER FRITTI IN STS L: 32 cm	SECB270931	59	€ 6,31	
	PINZA PER DOLCI IN STS L: 20 cm	SECB811131	59	€ 18,62	
	PINZA PER CARNI E VEGETALI IN STS L:25cm	SECBL39931	59	€ 31,89	







# SISTEMI ESPOSITIVI

IMMAGINE	DESCRIZIONE	CODICE E COLORE	PAG CAT	PREZZO	NOTE
	PALETTA CON FORI IN STS L: 48 cm	SECB270231	59	€ 22,10	
	GHIRLANDA DI PREZZEMOLO IN PP D:200 cm	SECBPS10	61	€ 32,83	
	GHIRLANDA DI EDERA IN PP D: 180 cm	SECB1037	61	€ 29,69	
	VITE CON GRAPPOLI DI UVA NERA IN PP D:185 cm	SECBSB21	61	€ 52,00	
	GHIRLANDA AUTUNNALE IN PP D:200 cm	SECB1036	61	€ 38,12	

# SISTEMI ESPOSITIVI

IMMAGINE	DESCRIZIONE	CODICE E COLORE	PAG CAT	PREZZO	NOTE
	GHIRLANDA IN PVC TRASP.RETROSTAMPATO PEPERONCINO D: 100x5 H cm+PIEGA BASE 1 cm	SECBPEPR08	61	€ 11,22	* BIADESIVO O ADESIVO MAGNETIC O NON INCLUSO
	GHIRLANDA IN PVC TRASP.RETROSTAMPATO LIMONI D: 100 x 5 H cm +PIEGA BASE 1 cm	SECBLIMO08	61	€ 11,22	* BIADESIVO O ADESIVO MAGNETIC O NON INCLUSO
	GHIRLANDA IN PVC TRASP.RETROSTAMPATO UVA ROSSA D: 100 x 5 H cm +PIEGA BASE 1 cm	SECBUVAN08	61	€ 11,22	* BIADESIVO O ADESIVO MAGNETIC O NON INCLUSO
	GHIRLANDA IN PVC TRASP.RETROSTAMPATO UVA BIANCA D: 100 x 5 H cm +PIEGA BASE 1 cm	SECBUVAB08	61	€ 11,22	* BIADESIVO O ADESIVO MAGNETIC O NON INCLUSO
	GHIRLANDA IN PVC TRASP.RETROSTAMPATO ERBA D: 100 x 5 H cm +PIEGA BASE 1 cm	SEBERBA08	61	€ 11,22	* BIADESIVO O ADESIVO MAGNETIC O NON INCLUSO

# SISTEMI ESPOSITIVI

IMMAGINE	DESCRIZIONE	CODICE E COLORE	PAG CAT	PREZZO	NOTE
	GHIRLANDA IN PVC TRASP.RETROSTAMPATO PRATO FIORITO D: 100 x 5 H cm +PIEGA BASE 1 cm	SECBERBF08	61	€ 11,22	* BIADESIVO O ADESIVO MAGNETIC O NON INCLUSO
	GHIRLANDA IN PVC TRASP.RETROSTAMPATO POMODORO D: 100 x 5 H cm +PIEGA BASE 1 cm	SECBPOMR08	62	€ 11,22	* BIADESIVO O ADESIVO MAGNETIC O NON INCLUSO
	GHIRLANDA IN PVC TRASP.RETROSTAMPATO BASILICO D: 100 x 5 H cm +PIEGA BASE 1 cm	SECBBASI08	62	€ 11,22	* BIADESIVO O ADESIVO MAGNETIC O NON INCLUSO
	RAFIA 1Kg	SEACYT1K98	62	€ 32,49	
	JUTA D: 5000 x 137 H cm	SEACTX5098	62	€10,36/MT LINEARE	





# SISTEMI ESPOSITIVI

IMMAGINE	DESCRIZIONE	CODICE E COLORE	PAG CAT	PREZZO	NOTE
	TOVAGLIA CERATA EFFETTO LEGNO 20 MT D:2000x100 H cm	SECBTVCE34	62	€ 7,77	
	TAPPETO SPUGNOSO D: 65 cm x 15 mt	SETPSPCC05	62	€ 168,00	
	GHIRLANDA CON LIMONI L:180 cm	SECB2126	62	€ 78,50	
	GHIRLANDA DI RAFIA CON PEPERONCINI L:100cm	SECB1096	62	€ 22,80	
	GHIRLANDA DI POMODORI SAN MARZANO L: 50 cm	SECB1097	62	€ 28,77	

# SISTEMI ESPOSITIVI

IMMAGINE	DESCRIZIONE	CODICE E COLORE	PAG CAT	PREZZO	NOTE
	GHIRLANDA 12 AGLI L: 35 cm	SECB1098	62	€ 19,57	
	UVA NERA A GRAPPOLO IN PP	SECBUVAN99	63	€ 6,44	
	UVA BIANCA A GRAPPOLO IN PP	SECBUVAB99	63	€ 6,44	
	LIMONE IN PP	SECBFRLM99	63	€ 5,28	3 PZ
	MELA IN PP	SECBFRML99	63	€ 9,48	

# SISTEMI ESPOSITIVI

IMMAGINE	DESCRIZIONE	CODICE E COLORE	PAG CAT	PREZZO	NOTE
	BANANA IN PP	SECBFBN99	63	€ 14,73	2 PZ
	GRANA PADANO IN PP D: 45x 24 cm	SECBFOPR99	63	€ 134,40	
	PROSCIUTTO DI PARMA IN PP	SECBSAP99	63	€ 59,93	
	QUARTO DI PARMIGIANO IN PP D:20x18cm	SECQUPR99	63	€ 25,66	
	BAGUETTE IN PP	SECBBRBG99	63	€ 17,43	1 PZ

# SISTEMI ESPOSITIVI

IMMAGINE	DESCRIZIONE	CODICE E COLORE	PAG CAT	PREZZO	NOTE
	RETE 13 PESCI IN PP D: 2 x 1,5 mt	SECBRERET99	63	€ 72,06	
	GHIACCIO FRANTUMATO D: 4,5 x 3,5 cm	SECBGHIA99	63	€ 22,47	CONF DA 50 PZ

# COMUNICAZIONE PREZZO

IMMAGINE	DESCRIZIONE	CODICE E COLORE	PAG CAT	PREZZO	NOTE
	STAMPANTE PROFESSIONALE MAGICARD 300 D: 21,5 x 24,2 x 40,8 cm	CPSCMGC300	67	€ 2.598,00	
	NASTRO NERO STAMPA CARD BIANCHE NUM. STAMPE: 1000 (500 BIFACCIALI)	CPASCDRB05	68	€ 103,23	
	NASTRO BIANCO STAMPA CARD NERE NUM. STAMPE: 1000 (500 BIFACCIALI)	CPASCDRB01	68	€ 103,23	
	NASTRO A COLORI STAMPA CARD BIANCHE NUM. STAMPE 300 (150 BIFACCIALI)	CPASCDRB99	68	€ 259,74	
	KIT CARD BIANCHE	CPASCDKC01	68	€ 149,85	CONF DA 500 PZ







# COMUNICAZIONE PREZZO

IMMAGINE	DESCRIZIONE	CODICE E COLORE	PAG CAT	PREZZO	NOTE
	KIT CARD NERE	CPASCDKC05	68	€ 110,08	CONF DA 500 PZ
	KIT PULIZIA STAMPANTE	CPASCDKTCL	68	€ 13,76	
	DISTINTIVI SUPERIORI "NOVITÀ" D: 8,5 x 4 cm *POSSIBILITÀ DI PERSONALIZZAZIONE	SUPSNOV	68	€ 11,66	CONF DA 25 PZ
	DISTINTIVI SUPERIORI "OFFERTA SPECIALE" D: 8,5 x 4 cm *POSSIBILITÀ DI PERSONALIZZAZIONE	SUPSOF	68	€ 11,66	CONF DA 25 PZ
	DISTINTIVI SUPERIORI "OFFERTA" D: 8,5 x 4 cm *POSSIBILITÀ DI PERSONALIZZAZIONE	SUPSOF	68	€ 11,66	CONF DA 25 PZ



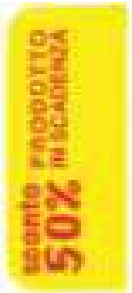

# COMUNICAZIONE PREZZO

IMMAGINE	DESCRIZIONE	CODICE E COLORE	PAG CAT	PREZZO	NOTE
	DISTINTIVI SUPERIORI "PREPARATO DA NOI" D: 8,5 x 4 cm *POSSIBILITÀ DI PERSONALIZZAZIONE	SUPSPDN	68	€ 11,66	CONF DA 25 PZ
	DISTINTIVI SUPERIORI "BIOLOGICO" D: 8,5 x 4 cm *POSSIBILITÀ DI PERSONALIZZAZIONE	SUPSBIO	68	€ 11,66	CONF DA 25 PZ
	DISTINTIVI SUPERIORI "FRESCO" D: 8,5 x 4 cm *POSSIBILITÀ DI PERSONALIZZAZIONE	SUPSFRE	68	€ 11,66	CONF DA 25 PZ
	DISTINTIVI SUPERIORI "VEGANO" D: 8,5 x 4 cm *POSSIBILITÀ DI PERSONALIZZAZIONE	SUPSVGN	68	€ 11,66	CONF DA 25 PZ
	DISTINTIVI SUPERIORI "PESCATO" D: 8,5 x 4 cm *POSSIBILITÀ DI PERSONALIZZAZIONE	SUPSPES	68	€ 11,66	CONF DA 25 PZ



# COMUNICAZIONE PREZZO

IMMAGINE	DESCRIZIONE	CODICE E COLORE	PAG CAT	PREZZO	NOTE
	DISTINTIVI LATERALI "BIOLOGICO" D: 5,4 x 2 cm *POSSIBILITÀ DI PERSONALIZZAZIONE	SUPLBIO	69	€ 6,66	CONF DA 25
	DISTINTIVI LATERALI "VEGETARIANO" D: 5,4 x 2 cm *POSSIBILITÀ DI PERSONALIZZAZIONE	SUPLVEG	69	€ 6,66	CONF DA 25
	DISTINTIVI LATERALI "VEGANO" D: 5,4 x 2 cm *POSSIBILITÀ DI PERSONALIZZAZIONE	SUPLVGN	69	€ 6,66	CONF DA 25
	DISTINTIVI LATERALI "SCONTO 50% PRODOTTO IN SCADENZA" D: 5,4 x 2 cm *POSSIBILITÀ DI PERSONALIZZAZIONE	SUPLSC	69	€ 6,66	CONF DA 25
	DISTINTIVI LATERALI "OFFERTA" D: 5,4 x 2 cm *POSSIBILITÀ DI PERSONALIZZAZIONE	SUPLOFF	69	€ 6,66	CONF DA 25

# COMUNICAZIONE PREZZO

IMMAGINE	DESCRIZIONE	CODICE E COLORE	PAG CAT	PREZZO	NOTE
	DISTINTIVI LATERALI "OFFERTA SPECIALE" D: 5,4 x 2 cm *POSSIBILITÀ DI PERSONALIZZAZIONE	SUPLOFS	69	€ 6,66	CONF DA 25
	DISTINTIVI LATERALI "PREPARATO DA NOI" D: 5,4 x 2 cm *POSSIBILITÀ DI PERSONALIZZAZIONE	SUPLPDN	69	€ 6,66	CONF DA 25
	DISTINTIVI LATERALI "PRONTO A CUOCERE" D: 5,4 x 2 cm *POSSIBILITÀ DI PERSONALIZZAZIONE	SUPLPC	69	€ 6,66	CONF DA 25
	DISTINTIVI LATERALI "CARNE CHIANINA" D: 5,4 x 2 cm *POSSIBILITÀ DI PERSONALIZZAZIONE	SUPLCC	69	€ 6,66	CONF DA 25
	DISTINTIVI LATERALI "CARNE ARGENTINA" D: 5,4 x 2 cm *POSSIBILITÀ DI PERSONALIZZAZIONE	SUPLCAR	69	€ 6,66	CONF DA 25





# COMUNICAZIONE PREZZO

IMMAGINE	DESCRIZIONE	CODICE E COLORE	PAG CAT	PREZZO	NOTE
	DISTINTIVI LATERALI "CARNE ITALIANA" D: 5,4 x 2 cm *POSSIBILITÀ DI PERSONALIZZAZIONE	SUPLCIT	69	€ 6,66	CONF DA 25
	DISTINTIVI LATERALI "CARNE DANESE" D: 5,4 x 2 cm *POSSIBILITÀ DI PERSONALIZZAZIONE	SUPLCD	69	€ 6,66	CONF DA 25
	DISTINTIVI LATERALI "PRODOTTO A KM Ø" D: 5,4 x 2 cm *POSSIBILITÀ DI PERSONALIZZAZIONE	SUPLPK	69	€ 6,66	CONF DA 25
	DISTINTIVI LATERALI "SENZA GLUTINE" D: 5,4 x 2 cm *POSSIBILITÀ DI PERSONALIZZAZIONE	SUPLSG	69	€ 6,66	CONF DA 25
	DISTINTIVI LATERALI "CONVIENE" D: 5,4 x 2 cm *POSSIBILITÀ DI PERSONALIZZAZIONE	SUPLCON	69	€ 6,66	CONF DA 25



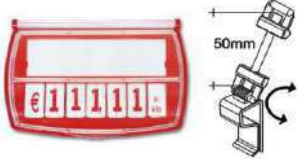
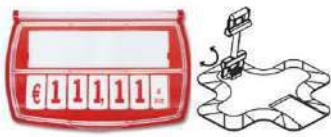

# COMUNICAZIONE PREZZO

IMMAGINE	DESCRIZIONE	CODICE E COLORE	PAG CAT	PREZZO	NOTE
	DISTINTIVI LATERALI "PRODOTTO DEL TERRITORIO" D: 5,4 x 2 cm *POSSIBILITÀ DI PERSONALIZZAZIONE	SUPLPT	69	€ 6,66	CONF DA 25
	SUPPORTO CARD A H D: 8,8 x 4,7 cm	CPPCTBC	69	€ 7,46	CONF DA 25
	ADATTATORE VERTICALE IN POM	CPAAMU64	69	€ 5,63	CONF DA 25 PZ
	SEGNAPREZZO SEMIERMETICO ETIJACK CON VETRINO AD EFFETTO LENTE IN ABS+PMMA CON ADATTATORI PIANI D: 10,6 x 8 H cm	CPSPJK2002 CPSPJK2003 CPSPJK2005 CPSPJK2006 CPSPJK2007	71	€ 79,42	CONF DA 25 PZ
	SEGNAPREZZO SEMIERMETICO ETIJACK CON VETRINO AD EFFETTO LENTE IN ABS+PMMA CON AGHI DOPPIA PUNTA E MOLLETTE CON ASTA DA 50 mm D: 10,6 x 8 H cm	CPSPJK0202 CPSPJK0203 CPSPJK0205 CPSPJK0206 CPSPJK0207	CAT 2017	€ 110,12	CONF DA 25 PZ

# COMUNICAZIONE PREZZO

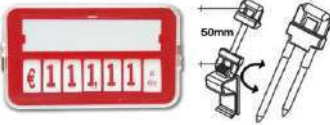



IMMAGINE	DESCRIZIONE	CODICE E COLORE	PAG CAT	PREZZO	NOTE
	SEGNAPREZZO SEMIERMETICO ETIJACK CON VETRINO AD EFFETTO LENTE IN ABS+PMMA CON AGHI INOX D: 10,6 x 8 H cm	CPSPJK0302 CPSPJK0303 CPSPJK0305 CPSPJK0306 CPSPJK0307	CAT 2017	€ 93,26	CONF DA 25 PZ
	SEGNAPREZZO SEMIERMETICO ETIJACK CON VETRINO AD EFFETTO LENTE IN ABS+PMMA CON AGHI DOPPIA PUNTA D: 10,6 x 8 H cm	CPSPJK0402 CPSPJK0403 CPSPJK0405 CPSPJK0406 CPSPJK0407	CAT 2017	€ 90,17	CONF DA 25 PZ
	SEGNAPREZZO SEMIERMETICO ETIJACK CON VETRINO AD EFFETTO LENTE IN ABS+PMMA CON MOLLETTE CON ASTA DA 50 mm D: 10,6 x 8 H cm	CPSPJK0602 CPSPJK0603 CPSPJK0605 CPSPJK0606 CPSPJK0607	CAT 2017	€ 95,40	CONF DA 25 PZ
	SEGNAPREZZO SEMIERMETICO ETIJACK CON VETRINO AD EFFETTO LENTE IN ABS+PMMA CON BASI A QUADRIFOGLIO E ASTA DA 50 mm D: 10,6 x 8 H cm	CPSPJK6002 CPSPJK6003 CPSPJK6005 CPSPJK6006 CPSPJK6007	CAT 2017	€ 106,32	CONF DA 25 PZ
	SEGNAPREZZO ERMETICO ETISABY DOPPIO UTILIZZO IN ABS+PMMA CON ADATTATORI E NUMERI AD INSERIMENTO D: 10,6 x 8 H cm	CPSPSB2002 CPSPSB2003 CPSPSB2005 CPSPSB2006 CPSPSB2007	71	€ 58,00	CONF DA 25 PZ

# COMUNICAZIONE PREZZO





IMMAGINE	DESCRIZIONE	CODICE E COLORE	PAG CAT	PREZZO	NOTE
	SEGNAPREZZO SEMIERMETICO ETISABI CON VETRINO AD EFFETTO LENTE IN ABS+PMMA CON AGHI DOPPIA PUNTA E MOLLETTE CON ASTA DA 50 mm D: 10,6 x 8 H cm	CPSPSB0202 CPSPSB0203 CPSPSB0205 CPSPSB0206 CPSPSB0207	CAT 2017	€ 89,78	CONF DA 25 PZ
	SEGNAPREZZO SEMIERMETICO ETISABI CON VETRINO AD EFFETTO LENTE IN ABS+PMMA CON AGHI INOX D: 10,6 x 8 H cm	CPSPSB0302 CPSPSB0303 CPSPSB0305 CPSPSB0306 CPSPSB0307	CAT 2017	€ 72,91	CONF DA 25 PZ
	SEGNAPREZZO SEMIERMETICO ETIJACK CON VETRINO AD EFFETTO LENTE IN ABS+PMMA CON AGHI DOPPIA PUNTA D: 10,6 x 8 H cm	CPSPSB0402 CPSPSB0403 CPSPSB0405 CPSPSB0406 CPSPSB0407	CAT 2017	€ 69,83	CONF DA 25 PZ
	SEGNAPREZZO SEMIERMETICO ETISABI CON VETRINO AD EFFETTO LENTE IN ABS+PMMA CON MOLLETTE CON ASTA DA 50 mm D: 10,6 x 8 H cm	CPSPSB0602 CPSPSB0603 CPSPSB0605 CPSPSB0606 CPSPSB0607	CAT 2017	€ 75,05	CONF DA 25 PZ
	SEGNAPREZZO SEMIERMETICO ETISABI CON VETRINO AD EFFETTO LENTE IN ABS+PMMA CON BASI A QUADRIFOGLIO E ASTA DA 50 mm D: 10,6 x 8 H cm	CPSPSB6002 CPSPSB6003 CPSPSB6005 CPSPSB6006 CPSPSB6007	CAT 2017	€ 85,98	CONF DA 25 PZ







# COMUNICAZIONE PREZZO

IMMAGINE	DESCRIZIONE	CODICE E COLORE	PAG CAT	PREZZO	NOTE
	SEGNAPREZZO PORTA ETICHETTE TRASPARENTE MINITASCA IN PP CON ADATTATORI VERTICALI D: 9,8 x 6,8 H cm	CPSPMT2008	71	€ 23,30	CONF DA 25 PZ
	SEGNAPREZZO PORTA ETICHETTE TRASPARENTE MINITASCA IN PP CON AGHI DOPPIA PUNTA E MOLLETTE CON ASTA DA 5 mm D: 9,8 x 6,8 H cm	CPSPMT0208	CAT 2017	€ 56,92	CONF DA 25 PZ
	SEGNAPREZZO PORTA ETICHETTE TRASPARENTE MINITASCA IN PP CON AGHI INOX D: 9,8 x 6,8 H cm	CPSPMT0308	CAT 2017	€ 40,05	CONF DA 25 PZ
	SEGNAPREZZO PORTA ETICHETTE TRASPARENTE MINITASCA IN PP CON AGHI DOPPIA PUNTA D: 9,8 x 6,8 H cm	CPSPMT0408	CAT 2017	€ 36,95	CONF DA 25 PZ
	SEGNAPREZZO PORTA ETICHETTE TRASPARENTE MINITASCA IN PP CON ADATTATORI D: 9,8 x 6,8 H cm	CPSPMT0608	CAT 2017	€ 42,19	CONF DA 25 PZ

# COMUNICAZIONE PREZZO

IMMAGINE	DESCRIZIONE	CODICE E COLORE	PAG CAT	PREZZO	NOTE
	SEGNAPREZZO PORTA ETICHETTE TRASPARENTE MINITASCA IN PP CON BASI QUADRIFOGLIO CON ASTA DA 50 mm D: 9,8 x 6,8 H cm	CPSPMT6008	CAT 2017	€ 53,12	CONF DA 25 PZ
	SUPPLEMENTO PROMOZIONALE "OFFERTA" PER MINITASCA IN PP D: 9,8 x 3,2 cm	CPSPMT30	71	€ 12,47	CONF DA 25 PZ
	SUPPLEMENTO PROMOZIONALE "NOVITÀ" PER MINITASCA IN PP D: 9,8 x 3,2 cm	CPSPMT31	71	€ 12,47	CONF DA 25 PZ
	SUPPLEMENTO PROMOZIONALE "PROMOZIONE" PER MINITASCA IN PP D: 9,8 x 3,2 cm	CPSPMT34	71	€ 12,47	CONF DA 25 PZ
	SEGNAPREZZO PORTA ETICHETTE TRASPARENTE TASCA IN PP CON ADATTATORI VERTICALI D: 11,5 x 8,5 H cm	CPSPTA2008	72	€ 28,30	CONF DA 25 PZ





# COMUNICAZIONE PREZZO

IMMAGINE	DESCRIZIONE	CODICE E COLORE	PAG CAT	PREZZO	NOTE
	<p>SEGNAPREZZO PORTA ETICHETTE TRASPARENTE TASCA IN PP CON AGHI DOPPIA PUNTA E MOLLETTE CON ASTA DA 5 mm D: 11,5 x 8,5 H cm</p>	CPSPTA0208	CAT 2017	€ 61,70	CONF DA 25 PZ
	<p>SEGNAPREZZO PORTA ETICHETTE TRASPARENTE TASCA IN PP CON AGHI INOX D: 11,5 x 8,5 H cm</p>	CPSPTA0308	CAT 2017	€ 44,84	CONF DA 25 PZ
	<p>SEGNAPREZZO PORTA ETICHETTE TRASPARENTE TASCA IN PP CON AGHI DOPPIA PUNTA D: 11,5 x 8,5 H cm</p>	CPSPTA0408	CAT 2017	€ 41,75	CONF DA 25 PZ
	<p>SEGNAPREZZO PORTA ETICHETTE TRASPARENTE TASCA IN PP CON ADATTATORI D: 11,5 x 8,5 H cm</p>	CPSPTA0608	CAT 2017	€ 46,98	CONF DA 25 PZ
	<p>SEGNAPREZZO PORTA ETICHETTE TRASPARENTE TASCA IN PP CON BASI QUADRIFOGLIO CON ASTA DA 50 mm D: 11,5 x 8,5 H cm</p>	CPSPTA6008	CAT 2017	€ 57,90	CONF DA 25 PZ





# COMUNICAZIONE PREZZO

IMMAGINE	DESCRIZIONE	CODICE E COLORE	PAG CAT	PREZZO	NOTE
	SUPPLEMENTO PROMOZIONALE "OFFERTA" PER TASCA IN PP D: 11 x 4,5 cm	CPSPTA30	72	€ 13,13	CONF DA 25 PZ
	SUPPLEMENTO PROMOZIONALE "NOVITÀ" PER TASCA IN PP D: 11 x 4,5 cm	CPSPTA31	72	€ 13,13	CONF DA 25 PZ
	SUPPLEMENTO PROMOZIONALE "PROMOZIONE" PER TASCA IN PP D: 11 x 4,5 cm	CPSPTA34	72	€ 13,13	CONF DA 25 PZ
	PORTA PREZZO PER VASCA SURGELATI CON SEGNAPREZZO IN PMMA SPESSORE 3 mm D: 8,5 x 35 H cm	CPSPVF3508	72	€ 10,50	
	PORTA PREZZO PER VASCA SURGELATI CON SEGNAPREZZO IN PMMA SPESSORE 3 mm D: 8,5 x 45 H cm	CPSPVF4508	72	€ 12,46	



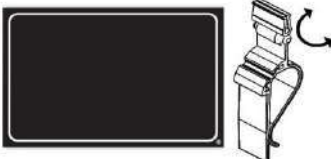

# COMUNICAZIONE PREZZO

IMMAGINE	DESCRIZIONE	CODICE E COLORE	PAG CAT	PREZZO	NOTE
	PORTA PREZZO PER VASCA SURGELATI CON SEGNAPREZZO IN PMMA SPESSORE 3 mm D: 8,5 x 55 H cm	CPSPVF5508	72	€ 14,45	
	SEGNAPREZZO CANCELLABILE NEUTRO IN PVC NERO SPESSORE 0,5 mm D: 10 x 7 H cm	CPLA010105	74	€ 12,30	CONF DA 25 PZ
	SEGNAPREZZO CANCELLABILE NEUTRO IN PVC NERO SPESSORE 0,5 mm CON AGHI INOX CON CLIP D: 10 x 7 H cm	CPLA010305	CAT 2017	€ 37,34	CONF DA 25 PZ+1 PENN
	SEGNAPREZZO CANCELLABILE NEUTRO IN PVC NERO SPESSORE 0,5 mm CON AGHI DOPPIA PUNTA CON CLIP D: 10 x 7 H cm	CPLA010405	CAT 2017	€ 34,25	CONF DA 25 PZ+1 PENN
	SEGNAPREZZO CANCELLABILE NEUTRO IN PVC NERO SPESSORE 0,5 mm CON MOLLETTE CON ASTA DA 50 mm E CLIP D: 10 x 7 H cm	CPLA010605	CAT 2017	€ 39,47	CONF DA 25 PZ+1 PENN



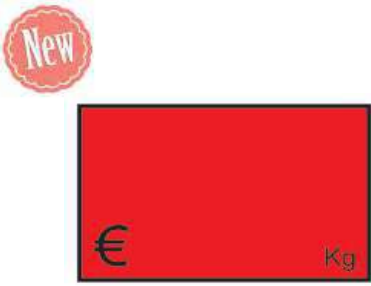

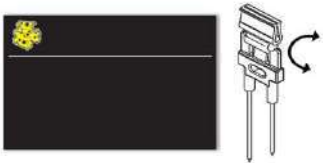
# COMUNICAZIONE PREZZO

IMMAGINE	DESCRIZIONE	CODICE E COLORE	PAG CAT	PREZZO	NOTE
	SEGNAPREZZO CANCELLABILE NEUTRO IN PVC NERO SPESSORE 0,5 mm AGHI DOPPIA PUNTA STANDARD D: 10 x 7 H cm	CPLA010705	CAT 2017	€ 26,41	CONF DA 25 PZ+1 PENN
	SEGNAPREZZO CANCELLABILE NEUTRO IN PVC NERO SPESSORE 0,5 mm CON MOLLETTA CON CLIP D: 10 x 7 H cm	CPLA011005	CAT 2017	€ 34,25	CONF DA 25 PZ+1 PENN
	SEGNAPREZZO CANCELLABILE NEUTRO IN PVC NERO SPESSORE 0,5 mm CON BASI QUADRIFOGLIO E ASTA 50 mm CON CLIP D: 10 x 7 H cm	CPLA016005	CAT 2017	€ 50,40	CONF DA 25 PZ+1 PENN
	SEGNAPREZZO CANCELLABILE BORDO LEGNO IN PVC NERO SPESSORE 0,5 mm D: 10 x 7 H cm	CPLAWD0101	74	€ 16,10	CONF DA 25 PZ
	SEGNAPREZZO CANCELLABILE PANETTERIA IN PVC NERO SPESSORE 0,5 mm D: 15 x 10 H cm	CPLA130105	74	€ 39,38	CONF DA 25 PZ

# COMUNICAZIONE PREZZO





IMMAGINE	DESCRIZIONE	CODICE E COLORE	PAG CAT	PREZZO	NOTE
	SEGNAPREZZO CANCELLABILE MACELLERIA IN FOREX SPESSORE 3 mm D: 12 x 8 H cm	CPLAF70106	74	€ 95,00	CONF DA 25 PZ
		CPLAF70106/10	FC	€ 38,00	CONF DA 10 PZ
	SEGNAPREZZO CANCELLABILE SERIE LAVAGNA PER FORMAGGI NERO D: 12 x 8 H cm	CPLA020105	CAT 2017	€ 13,60	CONF DA 25 PZ *ORDINE MINIMO 6 CONF
	SEGNAPREZZO CANCELLABILE SERIE LAVAGNA PER FORMAGGI BLACK CON AGHI INOX CON CLIP D: 12 x 8 H cm	CPLA020305	CAT 2017	€ 38,57	CONF DA 25 PZ+1 PENN *ORDINE MINIMO 6 CONF
	SEGNAPREZZO CANCELLABILE SERIE LAVAGNA PER FORMAGGI BLACK CON AGHI DOPPIA PUNTA CON CLIP D: 12 x 8 H cm	CPLA020405	CAT 2017	€ 35,48	CONF DA 25 PZ+1 PENN *ORDINE MINIMO 6 CONF
	SEGNAPREZZO CANCELLABILE SERIE LAVAGNA PER FORMAGGI BLACK CON MOLLETTE CON ASTE 50MM E CLIP D: 12 x 8 H cm	CPLA020605	CAT 2017	€ 40,71	CONF DA 25 PZ+1 PENN *ORDINE MINIMO 6 CONF

# COMUNICAZIONE PREZZO





IMMAGINE	DESCRIZIONE	CODICE E COLORE	PAG CAT	PREZZO	NOTE
	SEGNAPREZZO CANCELLABILE SERIE LAVAGNA PER FORMAGGI BLACK CON AGHI DOPPIA PUNTA STANDARD D: 12 x 8 H cm	CPLA020705	CAT 2017	€ 27,65	CONF DA 25 PZ+1 PENN *ORDINE MINIMO 6 CONF
	SEGNAPREZZO CANCELLABILE SERIE LAVAGNA PER FORMAGGI BLACK CON MOLLETTE CON CLIP D: 12 x 8 H cm	CPLA021005	CAT 2017	€ 35,48	CONF DA 25 PZ+1 PENN *ORDINE MINIMO 6 CONF
	SEGNAPREZZO CANCELLABILE SERIE LAVAGNA PER FORMAGGI BLACK CON BASI QUADRIFOGLIO ASTA 50MM E CLIP D: 12 x 8 H cm	CPLA026005	CAT 2017	€ 51,63	CONF DA 25 PZ+1 PENN *ORDINE MINIMO 6 CONF
	SEGNAPREZZO CANCELLABILE SERIE LAVAGNA PER CARNI BLACK D: 12 x 8 H cm	CPLA030105	CAT 2017	€ 13,60	CONF DA 25 PZ *ORDINE MINIMO 6 CONF
	SEGNAPREZZO CANCELLABILE SERIE LAVAGNA PER CARNI BLACK CON AGHI INOX CON CLIP D: 12 x 8 H cm	CPLA030305	CAT 2017	€ 38,57	CONF DA 25 PZ+1 PENN *ORDINE MINIMO 6 CONF

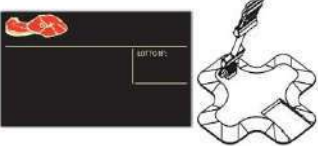





# COMUNICAZIONE PREZZO

IMMAGINE	DESCRIZIONE	CODICE E COLORE	PAG CAT	PREZZO	NOTE
	SEGNAPREZZO CANCELLABILE SERIE LAVAGNA PER CARNI BLACK CON AGHI DOPPIA PUNTA CON CLIP D: 12 x 8 H cm	CPLA030405	CAT 2017	€ 35,48	CONF DA 25 PZ+1 PENN *ORDINE MINIMO 6 CONF
	SEGNAPREZZO CANCELLABILE SERIE LAVAGNA PER CARNI BLACK CON MOLLETTE CON ASTE DA 50MM E CLIP D: 12 x 8 H cm	CPLA030650	CAT 2017	€ 40,71	CONF DA 25 PZ+1 PENN *ORDINE MINIMO 6 CONF
	SEGNAPREZZO CANCELLABILE SERIE LAVAGNA PER CARNI BLACK CON AGHI DOPPIA PUNTA STANDARD D: 12 x 8 H cm	CPLA030705	CAT 2017	€ 27,65	CONF DA 25 PZ+1 PENN
	SEGNAPREZZO CANCELLABILE SERIE LAVAGNA PER CARNI BLACK CON MOLLETTE CON CLIP D: 12 x 8 H cm	CPLA031005	CAT 2017	€ 35,48	CONF DA 25 PZ+1 PENN *ORDINE MINIMO 6 CONF
	SEGNAPREZZO CANCELLABILE SERIE LAVAGNA PER CARNI BLACK CON BASI QUADRIFOGLIO ASTA 50MM CON CLIP D: 12 x 8 H cm	CPLA036005	CAT 2017	€ 51,63	CONF DA 25 PZ+1 PENN *ORDINE MINIMO 6 CONF



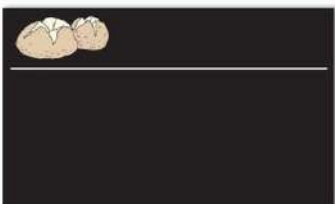

# COMUNICAZIONE PREZZO

IMMAGINE	DESCRIZIONE	CODICE E COLORE	PAG CAT	PREZZO	NOTE
	SEGNAPREZZO CANCELLABILE SERIE LAVAGNA PER SALUMI BLACK D: 12 x 8 H cm	CPLA040105	CAT 2017	€ 13,60	CONF DA 25 PZ *ORDINE MINIMO 6 CONF
	SEGNAPREZZO CANCELLABILE SERIE LAVAGNA PER SALUMI BLACK CON AGHI INOX CON CLIP D: 12 x 8 H cm	CPLA040305	CAT 2017	€ 38,57	CONF DA 25 PZ+1 PENN *ORDINE MINIMO 6 CONF
	SEGNAPREZZO CANCELLABILE SERIE LAVAGNA PER SALUMI BLACK CON AGHI DOPPIA PUNTA CON CLIP D: 12 x 8 H cm	CPLA040405	CAT 2017	€ 35,48	CONF DA 25 PZ+1 PENN *ORDINE MINIMO 6 CONF
	SEGNAPREZZO CANCELLABILE SERIE LAVAGNA PER SALUMI BLACK CON MOLLETTE CON ASTE DA 50MM E CLIP D: 12 x 8 H cm	CPLA040605	CAT 2017	€ 40,71	CONF DA 25 PZ+1 PENN *ORDINE MINIMO 6 CONF
	SEGNAPREZZO CANCELLABILE SERIE LAVAGNA PER SALUMI BLACK CON AGHI DOPPIA PUNTA STANDARD D: 12 x 8 H cm	CPLA040705	CAT 2017	€ 27,65	CONF DA 25 PZ+1 PENN *ORDINE MINIMO 6 CONF



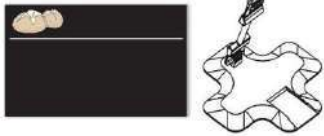

# COMUNICAZIONE PREZZO

IMMAGINE	DESCRIZIONE	CODICE E COLORE	PAG CAT	PREZZO	NOTE
	SEGNAPREZZO CANCELLABILE SERIE LAVAGNA PER SALUMI BLACK CON MOLLETTE CON CLIP D: 12 x 8 H cm	CPLA041005	CAT 2017	€ 35,48	CONF DA 25 PZ+1 PENN *ORDINE MINIMO 6 CONF
	SEGNAPREZZO CANCELLABILE SERIE LAVAGNA PER SALUMI BLACK CON BASI QUADRIFOGLIO ASTA 50MM E CLIP D: 12 x 8 H cm	CPLA046005	CAT 2017	€ 51,63	CONF DA 25 PZ+1 PENN *ORDINE MINIMO 6 CONF
	SEGNAPREZZO CANCELLABILE SERIE LAVAGNA PER PANE BLACK D: 12 x 8 H cm	CPLA060105	CAT 2017	€ 13,60	CONF DA 25 PZ *ORDINE MINIMO 6 CONF
	SEGNAPREZZO CANCELLABILE SERIE LAVAGNA PER PANE BLACK CON MOLLETTE CON ASTE DA 50MM E CLIP D: 12 x 8 H cm	CPLA060605	CAT 2017	€ 40,71	CONF DA 25 PZ+1 PENN *ORDINE MINIMO 6 CONF
	SEGNAPREZZO CANCELLABILE SERIE LAVAGNA PER PANE BLACK CON MOLLETTE CON CLIP D: 12 x 8 H cm	CPLA061005	CAT 2017	€ 35,48	CONF DA 25 PZ+1 PENN *ORDINE MINIMO 6 CONF

# COMUNICAZIONE PREZZO

IMMAGINE	DESCRIZIONE	CODICE E COLORE	PAG CAT	PREZZO	NOTE
	SEGNAPREZZO CANCELLABILE SERIE LAVAGNA PER PANE BLACK CON BASI QUADRIFOGLIO ASTA 50MM CON CLIP D: 12 x 8 H cm	CPLA066005	CAT 2017	€ 51,63	CONF DA 25 PZ+1 PENN *ORDINE MINIMO 6 CONF
	SEGNAPREZZO CANCELLABILE SERIE LAVAGNA PER FRUTTA BLACK D: 12 x 8 H cm	CPLA070105	CAT 2017	€ 13,60	CONF DA 25 PZ *ORDINE MINIMO 6 CONF
	SEGNAPREZZO CANCELLABILE SERIE LAVAGNA PER FRUTTA BLACK CON MOLLETTE CON ASTE DA 50MM CON CLIP D: 12 x 8 H cm	CPLA070605	CAT 2017	€ 40,71	CONF DA 25 PZ+1 PENN *ORDINE MINIMO 6 CONF
	SEGNAPREZZO CANCELLABILE SERIE LAVAGNA PER FRUTTA BLACK CON CON ASTA TRIANGOLARE D: 12 x 8 H cm	CPLA070805	CAT 2017	€ 28,60	CONF DA 25 PZ+1 PENN *ORDINE MINIMO 6 CONF
	SEGNAPREZZO CANCELLABILE SERIE LAVAGNA PER FRUTTA BLACK CON MOLLETTE CON CLIP D: 12 x 8 H cm	CPLA071005	CAT 2017	€ 35,48	CONF DA 25 PZ+1 PENN *ORDINE MINIMO 6 CONF

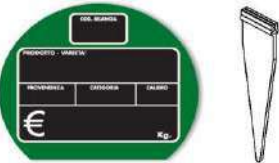
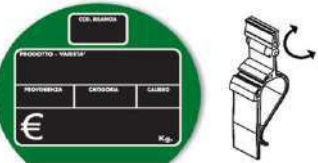



# COMUNICAZIONE PREZZO

IMMAGINE	DESCRIZIONE	CODICE E COLORE	PAG CAT	PREZZO	NOTE
	SEGNAPREZZO CANCELLABILE SERIE LAVAGNA PER FRUTTA TRACCIABILITÀ PRODOTTO D: 14,5 x 12 H cm	CPLA080105	CAT 2017	€ 21,30	CONF DA 25 PZ *ORDINE MINIMO 6 CONF
	SEGNAPREZZO CANCELLABILE SERIE LAVAGNA PER FRUTTA TRACCIABILITÀ PRODOTTO CON MOLLETTE CON ASTE DA 50MM CON CLIP D: 14,5 x 12 H cm	CPLA080605	CAT 2017	€ 48,02	CONF DA 25 PZ+1 PENN *ORDINE MINIMO 6 CONF
	SEGNAPREZZO CANCELLABILE SERIE LAVAGNA PER FRUTTA TRACCIABILITÀ PRODOTTO CON CON ASTA TRIANGOLARE D: 14,5 x 12 H cm	CPLA080805	CAT 2017	€ 35,91	CONF DA 25 PZ+1 PENN *ORDINE MINIMO 6 CONF
	SEGNAPREZZO CANCELLABILE SERIE LAVAGNA PER FRUTTA TRACCIABILITÀ PRODOTTO CON MOLLETTE CON CLIP D: 14,5 x 12 H cm	CPLA081005	CAT 2017	€ 42,80	CONF DA 25 PZ+1 PENN *ORDINE MINIMO 6 CONF
	SEGNAPREZZO CANCELLABILE SERIE LAVAGNA PER FRUTTA TRACCIABILITÀ PRODOTTO D: 14 x 11 H cm	CPLA090105	CAT 2017	€ 31,70	CONF DA 25 PZ *ORDINE MINIMO 6 CONF



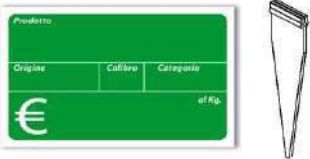
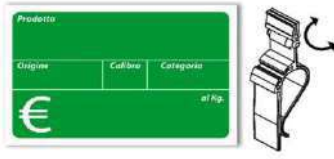

# COMUNICAZIONE PREZZO

IMMAGINE	DESCRIZIONE	CODICE E COLORE	PAG CAT	PREZZO	NOTE
	SEGNAPREZZO CANCELLABILE SERIE LAVAGNA PER FRUTTA TRACCIABILITÀ PRODOTTO CON MOLLETTE CON ASTE DA 50MM CON CLIP D: 14 x 11 H cm	CPLA090605	CAT 2017	€ 57,90	CONF DA 25 PZ+1 PENN *ORDINE MINIMO 6 CONF
	SEGNAPREZZO CANCELLABILE SERIE LAVAGNA PER FRUTTA TRACCIABILITÀ PRODOTTO CON CON ASTA TRIANGOLARE D: 14 x 11 H cm	CPLA090805	CAT 2017	€ 45,79	CONF DA 25 PZ+1 PENN *ORDINE MINIMO 6 CONF
	SEGNAPREZZO CANCELLABILE SERIE LAVAGNA PER FRUTTA TRACCIABILITÀ PRODOTTO CON MOLLETTE CON CLIP D: 14 x 11 H cm	CPLA091005	CAT 2017	€ 52,68	CONF DA 25 PZ+1 PENN *ORDINE MINIMO 6 CONF
	SEGNAPREZZO CANCELLABILE SERIE LAVAGNA PER ORTOFRUTTA TRACCIABILITÀ PRODOTTO D: 15 x 10 H cm	CPLA100105 CPLA100107	CAT 2017	€ 19,30	CONF DA 25 PZ
	SEGNAPREZZO CANCELLABILE SERIE LAVAGNA PER ORTOFRUTTA TRACCIABILITÀ PRODOTTO CON MOLLETTE CON ASTA 50MM E CLIP D: 15 x 10 H cm	CPLA100605 CPLA100607	CAT 2017	€ 46,12	CONF DA 25 PZ+1 PENN

# COMUNICAZIONE PREZZO





IMMAGINE	DESCRIZIONE	CODICE E COLORE	PAG CAT	PREZZO	NOTE
	<p>SEGNAPREZZO CANCELLABILE SERIE LAVAGNA PER ORTOFRUTTA TRACCIABILITÀ PRODOTTO CON ASTE TRIANGOLARI D: 15 x 10 H cm</p>	CPLA100805 CPLA100807	CAT 2017	€ 34,01	CONF DA 25 PZ+1 PENN
	<p>SEGNAPREZZO CANCELLABILE SERIE LAVAGNA PER ORTOFRUTTA TRACCIABILITÀ PRODOTTO CON MOLLETTE CON CLIP D: 15 x 10 H cm</p>	CPLA101005 CPLA101007	CAT 2017	€ 40,90	CONF DA 25 PZ+1 PENN
	<p>SEGNAPREZZO CANCELLABILE PER TRACCIABILITÀ PRODOTTO PESCHERIA IN PVC BIANCO SPESSORE 0,7 mm D: 15 x 10 H cm</p>	CPLA110101	74	€ 22,30	CONF DA 25 PZ
	<p>SEGNAPREZZO CANCELLABILE PER TRACCIABILITÀ PRODOTTO PESCHERIA IN PVC BIANCO SPESSORE 0,7 mm CON AGHI INOX E CLIP D: 15 x 10 H cm</p>	CPLA110301	CAT 2017	€ 46,84	CONF DA 25 PZ+1 PENN
	<p>SEGNAPREZZO CANCELLABILE PER TRACCIABILITÀ PRODOTTO PESCHERIA IN PVC BIANCO SPESSORE 0,7 mm CON AGHI DOPPIA PUNTA E CLIP D: 15 x 10 H cm</p>	CPLA110401	CAT 2017	€ 43,75	CONF DA 25 PZ+1 PENN

# COMUNICAZIONE PREZZO





IMMAGINE	DESCRIZIONE	CODICE E COLORE	PAG CAT	PREZZO	NOTE
	<p>SEGNAPREZZO CANCELLABILE PER TRACCIABILITÀ</p> <p>PRODOTTO PESCHERIA IN PVC BIANCO</p> <p>SPESSORE 0,7 mm CON MOLLETTE E ASTA 50 mm CON CLIP</p> <p>D: 15 x 10 H cm</p>	CPLA110601	CAT 2017	€ 48,97	CONF DA 25 PZ+1 PENN
	<p>SEGNAPREZZO CANCELLABILE PER TRACCIABILITÀ</p> <p>PRODOTTO PESCHERIA IN PVC BIANCO</p> <p>SPESSORE 0,7 mm CON ASTA GHIACCIO CON CLIP</p> <p>D: 15 x 10 H cm</p>	CPLA111101	CAT 2017	€ 44,60	CONF DA 25 PZ+1 PENN
	<p>SEGNAPREZZO CANCELLABILE PER TRACCIABILITÀ</p> <p>PRODOTTO PESCHERIA IN PVC BIANCO</p> <p>SPESSORE 0,7 mm CON ASTE TRIANGOLARI</p> <p>D: 15 x 10 H cm</p>	CPLA110801	CAT 2017	€ 36,86	CONF DA 25 PZ+1 PENN
	<p>SEGNAPREZZO CANCELLABILE PER TRACCIABILITÀ</p> <p>PRODOTTO PESCHERIA IN PVC BIANCO</p> <p>SPESSORE 0,7 mm CON MOLLETTE CON CLIP</p> <p>D: 15 x 10 H cm</p>	CPLA111001	CAT 2017	€ 43,75	CONF DA 25 PZ+1 PENN
	<p>SEGNAPREZZO CANCELLABILE PER TRACCIABILITÀ</p> <p>PRODOTTO PESCHERIA IN PVC BLU</p> <p>SPESSORE 0,7 mm</p> <p>D: 15 x 10 H cm</p>	CPLA120102	74	€ 22,30	CONF DA 25 PZ





# COMUNICAZIONE PREZZO

IMMAGINE	DESCRIZIONE	CODICE E COLORE	PAG CAT	PREZZO	NOTE
	<p>SEGNAPREZZO CANCELLABILE PER TRACCIABILITÀ PRODOTTO PESCHERIA IN PVC BLU SPESSORE 0,7 mm CON AGHI INOX E CLIP D: 15 x 10 H cm</p>	CPLA120302	CAT 2017	€ 46,84	CONF DA 25 PZ+1 PENN
	<p>SEGNAPREZZO CANCELLABILE PER TRACCIABILITÀ PRODOTTO PESCHERIA IN PVC BLU SPESSORE 0,7 mm CON AGHI DOPPIA PUNTA E CLIP D: 15 x 10 H cm</p>	CPLA120402	CAT 2017	€ 43,75	CONF DA 25 PZ+1 PENN
	<p>SEGNAPREZZO CANCELLABILE PER TRACCIABILITÀ PRODOTTO PESCHERIA IN PVC BLU SPESSORE 0,7 mm CON MOLLETTE E ASTA 50 mm CON CLIP D: 15 x 10 H cm</p>	CPLA120602	CAT 2017	€ 48,97	CONF DA 25 PZ+1 PENN
	<p>SEGNAPREZZO CANCELLABILE PER TRACCIABILITÀ PRODOTTO PESCHERIA IN PVC BLU SPESSORE 0,7 mm CON ASTA GHIACCIO CON CLIP D: 15 x 10 H cm</p>	CPLA121102	CAT 2017	€ 44,60	CONF DA 25 PZ+1 PENN
	<p>SEGNAPREZZO CANCELLABILE PER TRACCIABILITÀ PRODOTTO PESCHERIA IN PVC BLU SPESSORE 0,7 mm CON ASTE TRIANGOLARI D: 15 x 10 H cm</p>	CPLA120802	CAT 2017	€ 36,86	CONF DA 25 PZ+1 PENN



# COMUNICAZIONE PREZZO

IMMAGINE	DESCRIZIONE	CODICE E COLORE	PAG CAT	PREZZO	NOTE
	<p>SEGNAPREZZO CANCELLABILE PER TRACCIABILITÀ PRODOTTO PESCHERIA IN PVC BLU SPESSORE 0,7 mm CON MOLLETTE CON CLIP D: 15 x 10 H cm</p>	CPLA121002	CAT 2017	€ 43,75	CONF DA 25 PZ+1 PENN
	<p>SEGNAPREZZO MONOFACCIALE CANCELLABILE SERIE LAVAGNA ORTOFRUTTA A3 VERTICALE IN PVC NERO SPESSORE 0,5 mm D: 29,7 x 42 H cm</p>	CPLAMFA305	75	€ 45,00	CONF DA 10 PZ
	<p>SEGNAPREZZO BIFACCIALE CANCELLABILE SERIE LAVAGNA ORTOFRUTTA A3 VERTICALE IN PVC NERO SPESSORE 0,5 mm D: 29,7 x 42 H cm</p>	CPLABFA305	75	€ 60,00	CONF DA 10 PZ
	<p>SEGNAPREZZO MONOFACCIALE CANCELLABILE ORTOFRUTTA ORIZZONTALE "OFFERTA" IN PVC NERO SPESSORE 0,5 mm D: 29,7 x 21 H cm</p>	CPLAOFH405	75	€ 46,15	CONF DA 10 PZ
	<p>SEGNAPREZZO BIFACCIALE CANCELLABILE ORTOFRUTTA ORIZZONTALE "OFFERTA" IN PVC NERO SPESSORE 0,5 mm D: 29,7 x 21 H cm</p>	CPLABFH405	CAT 20	€ 49,15	CONF DA 10 PZ

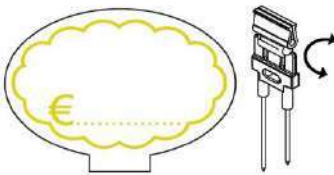
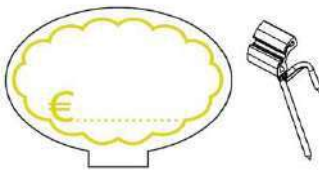

# COMUNICAZIONE PREZZO

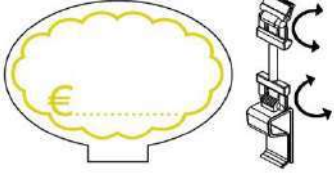
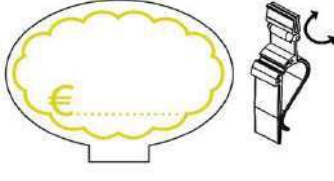
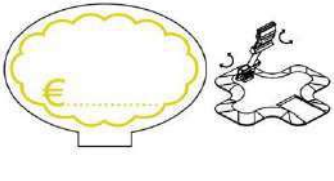
IMMAGINE	DESCRIZIONE	CODICE E COLORE	PAG CAT	PREZZO	NOTE
	SEGNAPREZZO MONOFACCIALE CANCELLABILE ORTOFRUTTA VERTICALE "OFFERTA" IN PVC NERO SPESSORE 0,5 mm D: 29,7 x 21 H cm	CPLAOFV405	75	€ 46,15	CONF DA 10 PZ
	SEGNAPREZZO BIFACCIALE CANCELLABILE ORTOFRUTTA VERTICALE "OFFERTA" IN PVC NERO SPESSORE 0,5 mm D: 29,7 x 21 H cm	CPLABFV405	CAT 20	€ 49,15	CONF DA 10 PZ
	SEGNAPREZZO CANCELLABILE SERIE PASTICCERIA IN PVC SPESSORE 0,7 mm D: 5 x 7 H cm *SENZA ACCESSORI	CPLAP10101	CAT 2017	€ 6,25	CONF DA 25 PZ *ORDINE MINIMO 6 CONF
	SEGNAPREZZO CANCELLABILE SERIE PASTICCERIA IN PVC SPESSORE 0,7 mm CON AGHI INOX E CLIP D: 5 x 7 H cm	CPLAP10301	CAT 2017	€ 31,59	CONF DA 25 PZ+1 PENN *ORDINE MINIMO 6 CONF
	SEGNAPREZZO CANCELLABILE SERIE PASTICCERIA IN PVC SPESSORE 0,7 mm CON AGHI DOPPIA PUNTA STANDARD D: 5 x 7 H cm	CPLAP10701	CAT 2017	€ 20,66	CONF DA 25 PZ+1 PENN *ORDINE MINIMO 6 CONF

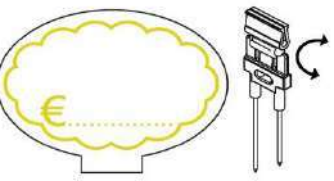

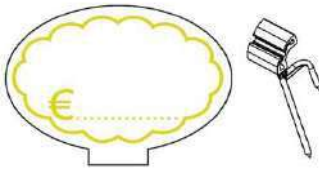
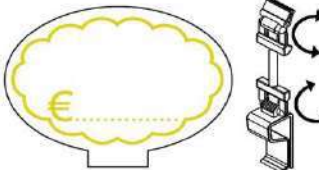
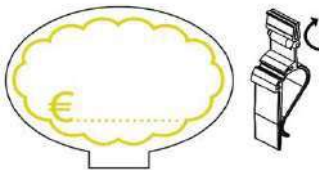
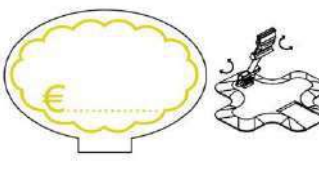

# COMUNICAZIONE PREZZO

IMMAGINE	DESCRIZIONE	CODICE E COLORE	PAG CAT	PREZZO	NOTE
	SEGNAPREZZO CANCELLABILE SERIE PASTICCERIA IN PVC SPESSORE 0,7 mm CON MOLLETTE E ASTA 50 MM CON CLIP D: 5 x 7 H cm	CPLAP10601	CAT 2017	€ 33,73	CONF DA 25 PZ+1 PENN *ORDINE MINIMO 6 CONF
	SEGNAPREZZO CANCELLABILE SERIE PASTICCERIA IN PVC SPESSORE 0,7 mm CON MOLLETTE CON CLIP D: 5 x 7 H cm	CPLAP11001	CAT 2017	€ 28,50	CONF DA 25 PZ+1 PENN *ORDINE MINIMO 6 CONF
	SEGNAPREZZO CANCELLABILE SERIE PASTICCERIA IN PVC SPESSORE 0,7 mm CON BASI A QUADRIFOGLIO E ASTA 50 MM CON CLIP D: 5 x 7 H cm	CPLAP16001	CAT 2017	€ 44,65	CONF DA 25 PZ+1 PENN *ORDINE MINIMO 6 CONF
	SEGNAPREZZO CANCELLABILE SERIE PASTICCERIA IN PVC SPESSORE 0,7 mm D: 9 x 6 H cm *SENZA ACCESSORI	CPLAP20101	76	€ 6,50	CONF DA 25 PZ *ORDINE MINIMO 6 CONF
	SEGNAPREZZO CANCELLABILE SERIE PASTICCERIA IN PVC SPESSORE 0,7 mm CON AGHI INOX E CLIP D: 9 x 6 H cm	CPLAP20301	CAT 2017	€ 31,59	CONF DA 25 PZ+1 PENN *ORDINE MINIMO 6 CONF



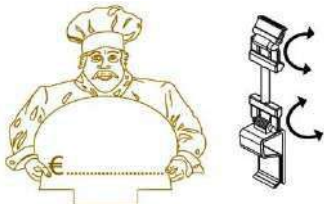
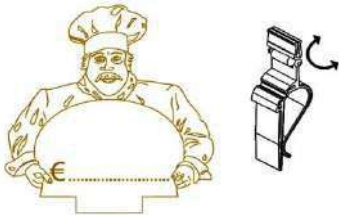

# COMUNICAZIONE PREZZO

IMMAGINE	DESCRIZIONE	CODICE E COLORE	PAG CAT	PREZZO	NOTE
	SEGNAPREZZO CANCELLABILE SERIE PASTICCERIA IN PVC SPESSORE 0,7 mm CON AGHI DOPPIA PUNTA STANDARD D: 9 x 6 H cm	CPLAP20701	CAT 2017	€ 20,66	CONF DA 25 PZ+1 PENN *ORDINE MINIMO 6 CONF
	SEGNAPREZZO CANCELLABILE SERIE PASTICCERIA IN PVC SPESSORE 0,7 mm CON MOLLETTE E ASTA 50 MM CON CLIP D: 9 x 6 H cm	CPLAP20601	CAT 2017	€ 33,73	CONF DA 25 PZ+1 PENN *ORDINE MINIMO 6 CONF
	SEGNAPREZZO CANCELLABILE SERIE PASTICCERIA IN PVC SPESSORE 0,7 mm CON MOLLETTE CON CLIP D: 9 x 6 H cm	CPLAP21001	CAT 2017	€ 28,50	CONF DA 25 PZ+1 PENN *ORDINE MINIMO 6 CONF
	SEGNAPREZZO CANCELLABILE SERIE PASTICCERIA IN PVC SPESSORE 0,7 mm CON BASI A QUADRIFOGLIO E ASTA 50 MM CON CLIP D: 9 x 6 H cm	CPLAP26001	CAT 2017	€ 44,65	CONF DA 25 PZ+1 PENN *ORDINE MINIMO 6 CONF
	SEGNAPREZZO CANCELLABILE SERIE PASTICCERIA IN PVC SPESSORE 0,7 mm D: 8 x 9 H cm *SENZA ACCESSORI	CPLAP30101	76	SP	CONF DA 25 PZ *ORDINE MINIMO 6 CONF



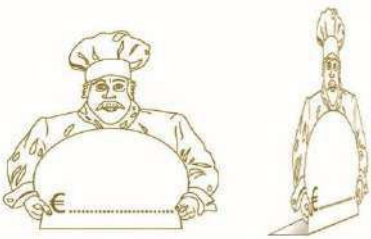

# COMUNICAZIONE PREZZO

IMMAGINE	DESCRIZIONE	CODICE E COLORE	PAG CAT	PREZZO	NOTE
	SEGNAPREZZO CANCELLABILE SERIE PASTICCERIA IN PVC SPESSORE 0,7 mm CON AGHI INOX CON CLIP D: 8 x 9 H cm	CPLAP30301	CAT 2017	SP	CONF DA 25 PZ+1 PENN *ORDINE MINIMO 6 CONF
	SEGNAPREZZO CANCELLABILE SERIE PASTICCERIA IN PVC SPESSORE 0,7 mm CON AGHI DOPPIA PUNTA STANDARD D: 8 x 9 H cm	CPLAP30701	CAT 2017	SP	CONF DA 25 PZ+1 PENN *ORDINE MINIMO 6 CONF
	SEGNAPREZZO CANCELLABILE SERIE PASTICCERIA IN PVC SPESSORE 0,7 mm CON MOLLETTE E ASTA 50 MM CON CLIP D: 8 x 9 H cm	CPLAP30601	CAT 2017	SP	CONF DA 25 PZ+1 PENN *ORDINE MINIMO 6 CONF
	SEGNAPREZZO CANCELLABILE SERIE PASTICCERIA IN PVC SPESSORE 0,7 mm CON MOLLETTE CON CLIP D: 8 x 9 H cm	CPLAP31001	CAT 2017	SP	CONF DA 25 PZ+1 PENN *ORDINE MINIMO 6 CONF
	SEGNAPREZZO CANCELLABILE SERIE PASTICCERIA IN PVC SPESSORE 0,7 mm CON BASI QUADRIFOGLIO E ASTA 50 MM CON CLIP D: 8 x 9 H cm	CPLAP36001	CAT 2017	SP	CONF DA 25 PZ+1 PENN *ORDINE MINIMO 6 CONF

# COMUNICAZIONE PREZZO





IMMAGINE	DESCRIZIONE	CODICE E COLORE	PAG CAT	PREZZO	NOTE
	SEGNAPREZZO DA APPOGGIO CANCELLABILE SERIE PASTICCERIA IN PVC SPESSORE 0,7 mm D: 8 x 9 H cm	CPLA50101	CAT 20	€ 16,80	CONF DA 25 PZ *ORDINE MINIMO 6 CONF
	SEGNAPREZZO CANCELLABILE SERIE PASTICCERIA IN PVC SPESSORE 0,7 mm D: 9 x 6 H cm *SENZA ACCESSORI	CPLAP70101	76		CONF DA 25 PZ
	SEGNAPREZZO CANCELLABILE SERIE PASTICCERIA IN PVC SPESSORE 0,7 mm D: 5,5 x 7 H cm *SENZA ACCESSORI	CPLAP60101	76		CONF DA 25 PZ
	SEGNAPREZZO CANCELLABILE SERIE LAVAGNA PPL "OFFERTA" CON INSERTO A "C" A7 D: 12 x 8 H cm	CPLAPF2006	CAT 2017	€ 34,50	CONF DA 25 PZ
	SEGNAPREZZO CANCELLABILE SERIE LAVAGNA PPL "OFFERTA" CON AGHI INOX D: 12 x 8 H cm	CPLAPF0306	CAT 2017	€ 50,59	CONF DA 25 PZ+1 PENN

# COMUNICAZIONE PREZZO



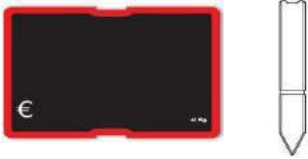

IMMAGINE	DESCRIZIONE	CODICE E COLORE	PAG CAT	PREZZO	NOTE
	SEGNAPREZZO CANCELLABILE SERIE LAVAGNA PPL "OFFERTA" CON CON AGHI DOPPIA PUNTA D: 12 x 8 H cm	CPLAPF0406	CAT 2017	€ 47,50	CONF DA 25 PZ+1 PENN
	SEGNAPREZZO CANCELLABILE SERIE LAVAGNA PPL "OFFERTA" CON CON MOLLETTE E ASTA 50 MM D: 12 x 8 H cm	CPLAPF0606	CAT 2017	€ 52,73	CONF DA 25 PZ+1 PENN
	SEGNAPREZZO CANCELLABILE SERIE LAVAGNA PPL "OFFERTA" CON ASTA GHIACCIO D: 12 x 8 H cm	CPLAPF1106	CAT 2017	€ 56,19	CONF DA 25 PZ+1 PENN
	SEGNAPREZZO CANCELLABILE SERIE LAVAGNA PPL "OFFERTA" CON BASI QUADRIFOGLIO E ASTA 50 MM D: 12 x 8 H cm	CPLAPF6006	CAT 2017	€ 63,65	CONF DA 25 PZ+1 PENN
	SEGNAPREZZO CANCELLABILE SERIE LAVAGNA PPL IN PP FUSTELLATO E STAMPATO IN SERIGRAFIA CON INSERTO A "C" A7 SPESSORE 1,2 mm D: 12 x 8 H cm	CPLAPL2002 CPLAPL2003 CPLAPL2004 CPLAPL2005 CPLAPL2006 CPLAPL2007	77	CONF DA 25 PZ	CONF DA 25 PZ





# COMUNICAZIONE PREZZO

IMMAGINE	DESCRIZIONE	CODICE E COLORE	PAG CAT	PREZZO	NOTE
	SEGNAPREZZO CANCELLABILE SERIE LAVAGNA PPL IN PP FUSTELLATO E STAMPATO IN SERIGRAFIA CON AGHI INOX SPESSORE 1,2 mm D: 12 x 8 H cm	CPLAPL0302 CPLAPL0303 CPLAPL0304 CPLAPL0305 CPLAPL0306 CPLAPL0307	CAT 2017	€ 50,59	CONF DA 25 PZ+1 PENN
	SEGNAPREZZO CANCELLABILE SERIE LAVAGNA PPL IN PP FUSTELLATO E STAMPATO IN SERIGRAFIA CON AGHI DOPPIA PUNTA SPESSORE 1,2 mm D: 12 x 8 H cm	CPLAPL0402 CPLAPL0403 CPLAPL0404 CPLAPL0405 CPLAPL0406 CPLAPL0407	CAT 2017	€ 47,50	CONF DA 25 PZ+1 PENN
	SEGNAPREZZO CANCELLABILE SERIE LAVAGNA PPL IN PP FUSTELLATO E STAMPATO IN SERIGRAFIA CON MOLLETTE E ASTA 50MM SPESSORE 1,2 mm D: 12 x 8 H cm	CPLAPL0602 CPLAPL0603 CPLAPL0604 CPLAPL0605 CPLAPL0606 CPLAPL0607	CAT 2017	€ 52,73	CONF DA 25 PZ+1 PENN
	SEGNAPREZZO CANCELLABILE SERIE LAVAGNA PPL IN PP FUSTELLATO E STAMPATO IN SERIGRAFIA CON ASTA GHIACCIO SPESSORE 1,2 mm D: 12 x 8 H cm	CPLAPL1102 CPLAPL1103 CPLAPL1104 CPLAPL1105 CPLAPL1106 CPLAPL1107	CAT 2017	€ 56,19	CONF DA 25 PZ+1 PENN
	SEGNAPREZZO CANCELLABILE SERIE LAVAGNA PPL IN PP FUSTELLATO E STAMPATO IN SERIGRAFIA CON BASI A QUADRIFOGLIO E ASTA 50 MM SPESSORE 1,2 mm D: 12 x 8 H cm	CPLAPL6002 CPLAPL6003 CPLAPL6004 CPLAPL6005 CPLAPL6006 CPLAPL6007	CAT 2017	€ 63,65	CONF DA 25 PZ+1 PENN

# COMUNICAZIONE PREZZO

IMMAGINE	DESCRIZIONE	CODICE E COLORE	PAG CAT	PREZZO	NOTE
	<p>SEGNAPREZZO CANCELLABILE SERIE LAVAGNA PPL IN PP PER TRACCIABILITÀ PESCHERIA CON INSERTO A "C" A6 SPESSORE 1,2 mm D: 15 x 11 H cm</p>	CPLAPP2005	77	€ 37,49	CONF DA 25 PZ
	<p>SEGNAPREZZO CANCELLABILE SERIE LAVAGNA PPL IN PP PER TRACCIABILITÀ PESCHERIA CON AGHI INOX SPESSORE 1,2 mm D: 15 x 11 H cm</p>	CPLAPP0305	CAT 2017	€ 53,43	CONF DA 25 PZ+1 PENN
	<p>SEGNAPREZZO CANCELLABILE SERIE LAVAGNA PPL IN PP PER TRACCIABILITÀ PESCHERIA CON AGHI DOPPIA PUNTA SPESSORE 1,2 mm D: 15 x 11 H cm</p>	CPLAPP0405	CAT 2017	€ 50,34	CONF DA 25 PZ+1 PENN
	<p>SEGNAPREZZO CANCELLABILE SERIE LAVAGNA PPL IN PP PER TRACCIABILITÀ PESCHERIA CON MOLLETTE E ASTE 50 MM SPESSORE 1,2 mm D: 15 x 11 H cm</p>	CPLAPP0605	CAT 2017	€ 55,57	CONF DA 25 PZ+1 PENN
	<p>SEGNAPREZZO CANCELLABILE SERIE LAVAGNA PPL IN PP PER TRACCIABILITÀ PESCHERIA CON ASTA GHIACCIO SPESSORE 1,2 mm D: 15 x 11 H cm</p>	CPLAPP1105	CAT 2017	€ 59,03	CONF DA 25 PZ+1 PENN

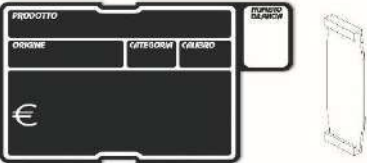
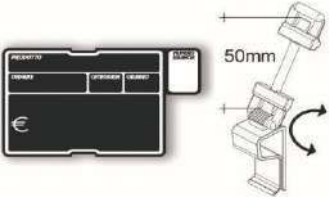
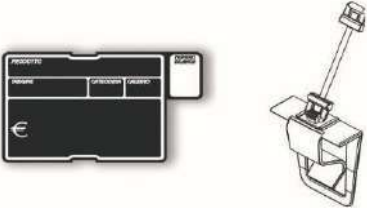

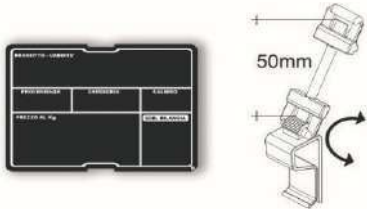

# COMUNICAZIONE PREZZO

IMMAGINE	DESCRIZIONE	CODICE E COLORE	PAG CAT	PREZZO	NOTE
	<p>SEGNAPREZZO CANCELLABILE SERIE LAVAGNA PPL IN PP PER TRACCIABILITÀ ORTOFRUTTA CON INSERTO A "C" A6 SPESSORE 1,2 mm D: 15 x 11 H cm</p>	CPLA1F2005	77	€ 34,50	CONF DA 25 PZ
	<p>SEGNAPREZZO CANCELLABILE SERIE LAVAGNA PPL IN PP PER TRACCIABILITÀ ORTOFRUTTA CON MOLLETTA CON ASTA 50 MM SPESSORE 1,2 mm D: 15 x 11 H cm</p>	CPLA1F0605	77	€ 52,73	CONF DA 25 PZ + PENN BIANCO
	<p>SEGNAPREZZO CANCELLABILE SERIE LAVAGNA PPL IN PP PER TRACCIABILITÀ ORTOFRUTTA CON MOLLETTONE CON ASTA 50 MM SPESSORE 1,2 mm D: 15 x 11 H cm</p>	CPLA1F3205	77	€ 66,98	CONF DA 25 PZ + PENN BIANCO
	<p>SEGNAPREZZO CANCELLABILE SERIE LAVAGNA PPL IN PP PER TRACCIABILITÀ ORTOFRUTTA 2 CON INSERTO A "C" A6 SPESSORE 1,2 mm D: 15 x 11 H cm</p>	CPLA2F2005	78	€ 34,50	CONF DA 25 PZ
	<p>SEGNAPREZZO CANCELLABILE SERIE LAVAGNA PPL IN PP PER TRACCIABILITÀ ORTOFRUTTA 2 CON MOLLETTA CON ASTA 50 MM SPESSORE 1,2 mm D: 15 x 11 H cm</p>	CPLA2F0605	78	€ 52,73	CONF DA 25 PZ + PENN BIANCO



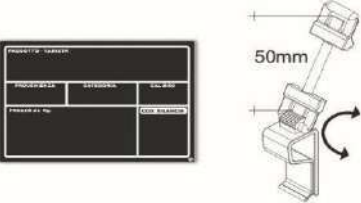

# COMUNICAZIONE PREZZO

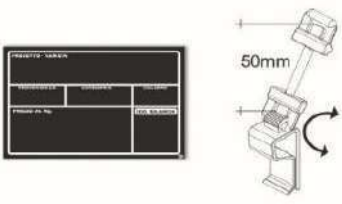
IMMAGINE	DESCRIZIONE	CODICE E COLORE	PAG CAT	PREZZO	NOTE
	<p>SEGNAPREZZO CANCELLABILE SERIE LAVAGNA PPL IN PP PER TRACCIABILITÀ ORTOFRUTTA 2 CON MOLLETTONE CON ASTA 50 MM SPESSORE 1,2 mm D: 15 x 11 H cm</p>	CPLA2F3205	78	€ 66,98	CONF DA 25 PZ + PENN BIANCO
	<p>SEGNAPREZZO CANCELLABILE SERIE LAVAGNA PPL IN PP PER TRACCIABILITÀ ORTOFRUTTA 3 CON INSERTO A "C" A6 SPESSORE 1,2 mm D: 15 x 11 H cm</p>	CPLA3F2005	78	€ 34,50	CONF DA 25 PZ
	<p>SEGNAPREZZO CANCELLABILE SERIE LAVAGNA PPL IN PP PER TRACCIABILITÀ ORTOFRUTTA 3 CON MOLLETTA CON ASTA 50 MM SPESSORE 1,2 mm D: 15 x 11 H cm</p>	CPLA3F0605	78	€ 52,73	CONF DA 25 PZ + PENN BIANCO
	<p>SEGNAPREZZO CANCELLABILE SERIE LAVAGNA PPL IN PP PER TRACCIABILITÀ ORTOFRUTTA 3 CON MOLLETTONE CON ASTA 50 MM SPESSORE 1,2 mm D: 15 x 11 H cm</p>	CPLA3F3205	78	€ 66,98	CONF DA 25 PZ + PENN BIANCO
 <p>*CON INGRANAGGIO POSTERIORE</p>	<p>SEGNAPREZZO A6 CANCELLABILE SERIE LAVAGNA IN FOREX PER TRACCIABILITÀ ORTOFRUTTA SPESSORE 3 mm D: 14,8 x 10,5 H cm</p>	CPLAF60105	79	€ 62,30	CONF DA 25 PZ

# COMUNICAZIONE PREZZO

IMMAGINE	DESCRIZIONE	CODICE E COLORE	PAG CAT	PREZZO	NOTE
	<p>SEGNAPREZZO A6 CANCELLABILE SERIE LAVAGNA IN FOREX PER TRACCIABILITÀ ORTOFRUTTA SPESSORE 3 mm CON MOLLETTA CON ASTA 50 MM D: 14,8 x 10,5 H cm</p>	CPLAF60605	79	€ 79,13	CONF DA 25 PZ + PENN BIANCO
	<p>SEGNAPREZZO A6 CANCELLABILE SERIE LAVAGNA IN FOREX PER TRACCIABILITÀ ORTOFRUTTA SPESSORE 3 mm CON PINZE 50 MM D: 14,8 x 10,5 H cm</p>	CPLAF63005	79	€ 101,94	CONF DA 25 PZ + PENN BIANCO
	<p>SEGNAPREZZO A6 CANCELLABILE SERIE LAVAGNA IN FOREX PER TRACCIABILITÀ ORTOFRUTTA SPESSORE 3 mm CON PINZE 150 MM D: 14,8 x 10,5 H cm</p>	CPLAF63105	79	€ 111,44	CONF DA 25 PZ + PENN BIANCO
 <p>*CON INGRANAGGIO POSTERIORE</p>	<p>SEGNAPREZZO A5 CANCELLABILE SERIE LAVAGNA IN FOREX PER TRACCIABILITÀ ORTOFRUTTA SPESSORE 3 mm D: 21 x 14,8 H cm</p>	CPLAF50105	79	€ 70,75	CONF DA 25 PZ
	<p>SEGNAPREZZO A5 CANCELLABILE SERIE LAVAGNA IN FOREX PER TRACCIABILITÀ ORTOFRUTTA SPESSORE 3 mm CON MOLLETTA CON ASTA 50 MM D: 21 x 14,8 H cm</p>	CPLAF50605	79	€ 87,16	CONF DA 25 PZ + PENN BIANCO





# COMUNICAZIONE PREZZO

IMMAGINE	DESCRIZIONE	CODICE E COLORE	PAG CAT	PREZZO	NOTE
	SEGNAPREZZO A5 CANCELLABILE SERIE LAVAGNA IN FOREX PER TRACCIABILITÀ ORTOFRUTTA SPESSORE 3 mm CON PINZE 50 MM D: 21 x 14,8 H cm	CPLAF53005	79	€ 109,96	CONF DA 25 PZ + PENN BIANCO
	SEGNAPREZZO A5 CANCELLABILE SERIE LAVAGNA IN FOREX PER TRACCIABILITÀ ORTOFRUTTA SPESSORE 3 mm CON PINZE 150 MM D: 21 x 14,8 H cm	CPLAF53105	79	€ 119,46	CONF DA 25 PZ + PENN BIANCO
	SEGNAPREZZO CANCELLABILE SERIE LAVAGNA IN FOREX EXTRA PER TRACCIABILITÀ ORTOFRUTTA SPESSORE 3 mm CON FORATURA 4 mm D: 21 x 20 H cm	CPLAXF0105	80	€ 38,30	CONF DA 10 PZ
	GANCIO METALLICO PER SOSPENSIONE D: 15 cm	CPAA015012	80	€ 24,00	CONF DA 40 PZ
	GANCIO METALLICO PER SOSPENSIONE D: 30 cm	CPAA030012	80	€ 29,20	CONF DA 40 PZ
	GANCIO METALLICO PER SOSPENSIONE D: 50 cm	CPAA050012	80	€ 32,00	CONF DA 40 PZ
	GANCIO METALLICO PER SOSPENSIONE D: 70 cm	CPAA070012	80	€ 34,80	CONF DA 40 PZ
	GANCIO METALLICO PER SOSPENSIONE D: 100 cm	CPAA0100012	80	€ 42,80	CONF DA 40 PZ

# COMUNICAZIONE PREZZO





IMMAGINE	DESCRIZIONE	CODICE E COLORE	PAG CAT	PREZZO	NOTE
	<p>SEGNAPREZZO IN FOREX EXTRA PER TRACCIABILITÀ ORTOFRUTTA</p> <p>SPESSORE 3 mm CON FORATURA 4 mm + MOLLETTA CON ASTA</p> <p>D: 21 x 20 cm</p>	CPLAXF0605	80	€ 44,37	CONF DA 10 PZ + PENN BIANCO
	<p>SEGNAPREZZO IN FOREX EXTRA PER TRACCIABILITÀ ORTOFRUTTA</p> <p>SPESSORE 3 mm CON FORATURA 4 mm + PINZE DA 50 mm</p> <p>D: 21 x 20 H cm</p>	CPLAXF3005	80	€ 53,49	CONF DA 10 PZ + PENN BIANCO
	<p>SEGNAPREZZO IN FOREX EXTRA PER TRACCIABILITÀ ORTOFRUTTA</p> <p>SPESSORE 3 mm CON FORATURA 4 mm + PINZE DA 150 mm</p> <p>D: 21 x 20 H cm</p>	CPLAXF3105	80	€ 57,29	CONF DA 10 PZ + PENN BIANCO
	<p>SEGNAPREZZO CANCELLABILE SERIE LAVAGNA IN FOREX EXTRA PER TRACCIABILITÀ ORTOFRUTTA</p> <p>SPESSORE 3 mm CON FORATURA 4 mm</p> <p>D: 29,7 x 31 H cm</p>	CPLAFF0105	80	€ 44,30	CONF DA 10 PZ
	<p>GANCIO METALLICO PER SOSPENSIONE</p> <p>D: 15 cm</p>	CPAA015012	80	€ 24,00	CONF DA 40 PZ
	<p>GANCIO METALLICO PER SOSPENSIONE</p> <p>D: 30 cm</p>	CPAA030012	80	€ 29,20	CONF DA 40 PZ
	<p>GANCIO METALLICO PER SOSPENSIONE</p> <p>D: 50 cm</p>	CPAA050012	80	€ 32,00	CONF DA 40 PZ
	<p>GANCIO METALLICO PER SOSPENSIONE</p> <p>D: 70 cm</p>	CPAA070012	80	€ 34,80	CONF DA 40 PZ
	<p>GANCIO METALLICO PER SOSPENSIONE</p> <p>D: 100 cm</p>	CPAA0100012	80	€ 42,80	CONF DA 40 PZ

# COMUNICAZIONE PREZZO

IMMAGINE	DESCRIZIONE	CODICE E COLORE	PAG CAT	PREZZO	NOTE
	SEGNAPREZZO IN FOREX EXTRA PER TRACCIABILITÀ ORTOFRUTTA SPESSORE 3 mm CON FORATURA 4 mm + PINZE DA 50 mm D: 29,7 x 31 H cm	CPLAFF3005	80	€ 59,19	CONF DA 10 PZ + PENN BIANCO
	SEGNAPREZZO IN FOREX EXTRA PER TRACCIABILITÀ ORTOFRUTTA SPESSORE 3 mm CON FORATURA 4 mm + PINZE DA 150 mm D: 29,7 x 31 H cm	CPLAFF3105	80	€ 62,99	CONF DA 10 PZ + PENN BIANCO
	SEGNAPREZZO CANCELLABILE SERIE LAVAGNA IN FOREX EXTRA PER TRACCIABILITÀ ORTOFRUTTA SPESSORE 3 mm CON FORATURA 4 mm D: 21 x 20 H cm	CPLAXV0105	81	€ 36,30	CONF DA 10 PZ
	GANCIO METALLICO PER SOSPENSIONE D: 15 cm	CPAA015012	81	€ 24,00	CONF DA 40 PZ
	GANCIO METALLICO PER SOSPENSIONE D: 30 cm	CPAA030012	81	€ 29,20	CONF DA 40 PZ
	GANCIO METALLICO PER SOSPENSIONE D: 50 cm	CPAA050012	81	€ 32,00	CONF DA 40 PZ
	GANCIO METALLICO PER SOSPENSIONE D: 70 cm	CPAA070012	81	€ 34,80	CONF DA 40 PZ
	GANCIO METALLICO PER SOSPENSIONE D: 100 cm	CPAA0100012	81	€ 42,80	CONF DA 40 PZ

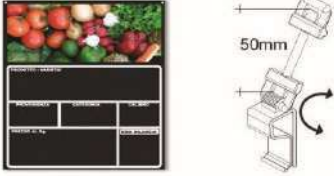





# COMUNICAZIONE PREZZO

IMMAGINE	DESCRIZIONE	CODICE E COLORE	PAG CAT	PREZZO	NOTE
	SEGNAPREZZO IN FOREX EXTRA PER TRACCIABILITÀ ORTOFRUTTA SPESSORE 3 mm CON FORATURA 4 mm + MOLLETTA CON ASTA D: 21 x 20 cm	CPLAXV0605	81	€ 42,47	CONF DA 10 PZ + PENN BIANCO
	SEGNAPREZZO IN FOREX EXTRA PER TRACCIABILITÀ ORTOFRUTTA SPESSORE 3 mm CON FORATURA 4 mm + PINZE DA 50 mm D: 21 x 20 H cm	CPLAXV3005	81	€ 51,59	CONF DA 10 PZ + PENN BIANCO
	SEGNAPREZZO IN FOREX EXTRA PER TRACCIABILITÀ ORTOFRUTTA SPESSORE 3 mm CON FORATURA 4 mm + PINZE DA 150 mm D: 21 x 20 H cm	CPLAXV3105	81	€ 55,39	CONF DA 10 PZ + PENN BIANCO
	SEGNAPREZZO CANCELLABILE SERIE LAVAGNA IN FOREX EXTRA PER TRACCIABILITÀ ORTOFRUTTA SPESSORE 3 mm CON FORATURA 4 mm D: 29,7 x 31 H cm	CPLAFV0105	81	€ 44,30	CONF DA 10 PZ
	GANCIO METALLICO PER SOSPENSIONE D: 15 cm	CPAA015012	81	€ 24,00	CONF DA 40 PZ
	GANCIO METALLICO PER SOSPENSIONE D: 30 cm	CPAA030012	81	€ 29,20	CONF DA 40 PZ
	GANCIO METALLICO PER SOSPENSIONE D: 50 cm	CPAA050012	81	€ 32,00	CONF DA 40 PZ
	GANCIO METALLICO PER SOSPENSIONE D: 70 cm	CPAA070012	81	€ 34,80	CONF DA 40 PZ
	GANCIO METALLICO PER SOSPENSIONE D: 100 cm	CPAA0100012	81	€ 42,80	CONF DA 40 PZ



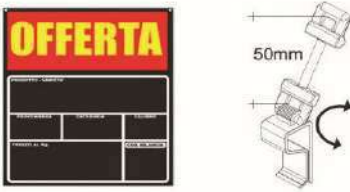



# COMUNICAZIONE PREZZO

IMMAGINE	DESCRIZIONE	CODICE E COLORE	PAG CAT	PREZZO	NOTE
	SEGNAPREZZO IN FOREX EXTRA PER TRACCIABILITÀ ORTOFRUTTA SPESSORE 3 mm CON FORATURA 4 mm + PINZE DA 50 mm D: 29,7 x 31 H cm	CPLAFV3005	81	€ 59,19	CONF DA 10 PZ + PENN BIANCO
	SEGNAPREZZO IN FOREX EXTRA PER TRACCIABILITÀ ORTOFRUTTA SPESSORE 3 mm CON FORATURA 4 mm + PINZE DA 150 mm D: 29,7 x 31 H cm	CPLAFV3105	81	€ 62,99	CONF DA 10 PZ + PENN BIANCO
	SEGNAPREZZO "OFFERTA" CANCELLABILE SERIE LAVAGNA IN FOREX EXTRA PER TRACCIABILITÀ ORTOFRUTTA SPESSORE 3 mm CON FORATURA 4 mm D: 21 x 20 H cm	CPLAOF0105	82	€ 36,30	CONF DA 10 PZ
	GANCIO METALLICO PER SOSPENSIONE D: 15 cm	CPAA015012	82	€ 24,00	CONF DA 40 PZ
	GANCIO METALLICO PER SOSPENSIONE D: 30 cm	CPAA030012	82	€ 29,20	CONF DA 40 PZ
	GANCIO METALLICO PER SOSPENSIONE D: 50 cm	CPAA050012	82	€ 32,00	CONF DA 40 PZ
	GANCIO METALLICO PER SOSPENSIONE D: 70 cm	CPAA070012	82	€ 34,80	CONF DA 40 PZ
	GANCIO METALLICO PER SOSPENSIONE D: 100 cm	CPAA0100012	82	€ 42,80	CONF DA 40 PZ

# COMUNICAZIONE PREZZO

IMMAGINE	DESCRIZIONE	CODICE E COLORE	PAG CAT	PREZZO	NOTE
	SEGNAPREZZO "OFFERTA" IN FOREX EXTRA PER TRACCIABILITÀ ORTOFRUTTA SPESSORE 3 mm CON FORATURA 4 mm + MOLLETTA CON ASTA D: 21 x 20 H cm	CPLAOF0605	82	€ 42,47	CONF DA 10 PZ + PENN BIANCO
	SEGNAPREZZO "OFFERTA" IN FOREX EXTRA PER TRACCIABILITÀ ORTOFRUTTA SPESSORE 3 mm CON FORATURA 4 mm + PINZE DA 50 mm D: 21 x 20 H cm	CPLAOF3005	82	€ 51,59	CONF DA 10 PZ + PENN BIANCO
	SEGNAPREZZO "OFFERTA" IN FOREX EXTRA PER TRACCIABILITÀ ORTOFRUTTA SPESSORE 3 mm CON FORATURA 4 mm + PINZE DA 150 mm D: 21 x 20 H cm	CPLAOF3105	82	€ 55,39	CONF DA 10 PZ + PENN BIANCO
	SEGNAPREZZO "OFFERTA" CANCELLABILE SERIE LAVAGNA IN FOREX EXTRA PER TRACCIABILITÀ ORTOFRUTTA SPESSORE 3 mm CON FORATURA 4 mm D: 29,7 x 31 H cm	CPLAOX0105	82	€ 44,30	CONF DA 10 PZ
	GANCIO METALLICO PER SOSPENSIONE D: 15 cm	CPAA015012	82	€ 24,00	CONF DA 40 PZ
	GANCIO METALLICO PER SOSPENSIONE D: 30 cm	CPAA030012	82	€ 29,20	CONF DA 40 PZ
	GANCIO METALLICO PER SOSPENSIONE D: 50 cm	CPAA050012	82	€ 32,00	CONF DA 40 PZ
	GANCIO METALLICO PER SOSPENSIONE D: 70 cm	CPAA070012	82	€ 34,80	CONF DA 40 PZ
	GANCIO METALLICO PER SOSPENSIONE D: 100 cm	CPAA0100012	82	€ 42,80	CONF DA 40 PZ

# COMUNICAZIONE PREZZO

IMMAGINE	DESCRIZIONE	CODICE E COLORE	PAG CAT	PREZZO	NOTE
	SEGNAPREZZO "OFFERTA" IN FOREX EXTRA PER TRACCIABILITÀ ORTOFRUTTA SPESSORE 3 mm CON FORATURA 4 mm + PINZE DA 50 mm D: 29,7 x 31 H cm	CPLAOX3005	82	€ 59,19	CONF DA 10 PZ + PENN BIANCO
	SEGNAPREZZO "OFFERTA" IN FOREX EXTRA PER TRACCIABILITÀ ORTOFRUTTA SPESSORE 3 mm CON FORATURA 4 mm + PINZE DA 150 mm D: 29,7 x 31 H cm	CPLAOX3105	82	€ 62,99	CONF DA 10 PZ + PENN BIANCO
	SEGNAPREZZO IN SUGHERO E FOREX 3 MM CON INGRANAGGIO D: 10,5X7 CM	CPSGDM0105	85	€ 14,05	CONF 5 PZ
	SEGNAPREZZO IN SUGHERO E FOREX 3 MM CON INGRANAGGIO E AGO INOX D: 10,5X7 CM	CPSGDM0201 CPSGDM0205	85	€ 17,80	CONF 5 PZ
	SEGNAPREZZO IN SUGHERO E FOREX 3 MM CON INGRANAGGIO E AGO DOPPIA PUNTA D: 10,5X7 CM	CPSGDM0301 CPSGDM0305	85	€ 17,15	CONF 5 PZ
	SEGNAPREZZO IN SUGHERO E FOREX 3 MM CON INGRANAGGIO E MOLLETTA D: 10,5X7 CM	CPSGDM0401 CPSGDM0405	85	€ 17,15	CONF 5 PZ





# COMUNICAZIONE PREZZO

IMMAGINE	DESCRIZIONE	CODICE E COLORE	PAG CAT	PREZZO	NOTE
	SEGNAPREZZO IN SUGHERO E FOREX 3 MM CON INGRANAGGIO, ASTA 5 CM E MOLLETTA D: 10,5X7 CM	CPSGDM0501 CPSGDM0505	85	€ 18,30	CONF 5 PZ
	SEGNAPREZZO IN SUGHERO E FOREX 3 MM CON INGRANAGGIO, ASTA 5 CM E PINZA D: 10,5X7 CM	CPSGDM0601 CPSGDM0605 CPSGDM0608	85	€ 23,15	CONF 5 PZ
	SEGNAPREZZO IN SUGHERO E FOREX 3 MM CON SNODO CON PINZA A MOLLA SENZA ASTA D: 10,5X7 CM	CPSGDM0701 CPSGDM0705 CPSGDM0708	85	€ 19,65	CONF 5 PZ
	SEGNAPREZZO IN SUGHERO E FOREX 3 MM CON SNODO CON PINZA A MOLLA CON ASTA 5 CM D: 10,5X7 CM	CPSGDM0801 CPSGDM0805 CPSGDM0808	85	€ 20,05	CONF 5 PZ
	PENNARELLO	CPIPCF0001 CPIPCF0005	85	€ 5,00	1 PZ
	KIT CARD	CPASCDMK01 CPASCDMK05	85	€ 2,50	CONF 5 PZ

# COMUNICAZIONE PREZZO

IMMAGINE	DESCRIZIONE	CODICE E COLORE	PAG CAT	PREZZO	NOTE
	SEGNAPREZZO CANCELLABILE IN PMMA PER TRACCIABILITÀ PESCHERIA SPESSORE 3 mm D: 13 x 20 H cm	CPLALR0102	86	€ 53,30	CONF DA 10 PZ + PENN BIANCO
	PELLICOLA PROTETTIVA A GANCIO PER SEGNAPREZZO CANCELLABILE IN PMMA	CPLALR0308	86	€ 6,66	CONF DA 10 PZ
	SEGNAPREZZO CANCELLABILE IN PMMA PER TRACCIABILITÀ PESCHERIA SPESSORE 3 mm CON PELLICOLA PROTETTIVA D: 13 x 20 H cm	CPLALR0402	86	€ 59,96	CONF DA 10 PZ + PENN BIANCO
	SEGNAPREZZO CANCELLABILE IN PMMA PER TRACCIABILITÀ PESCHERIA SPESSORE 3 mm CON SUPPLEMENTO PROMOZIONALE D: 13 x 24,6 H cm	CPLALR0202	86	€ 79,92	CONF DA 10 PZ + PENN BIANCO
	SEGNAPREZZO CANCELLABILE IN PMMA PER TRACCIABILITÀ PESCHERIA SPESSORE 3 mm D: 13 x 24,6 H cm *STAMPATO REVERSE	CPLALR0505	CAT 2020	€ 39,96	CONF DA 10 PZ + PENN BIANCO

# COMUNICAZIONE PREZZO



IMMAGINE	DESCRIZIONE	CODICE E COLORE	PAG CAT	PREZZO	NOTE
	FRECCIA PROMOZIONALE "OFFERTA LAST MINUTE" IN PMMA SPESSORE 3 mm D: 44 x 14 H cm	CGPSLRLM06	87	€ 55,94	CONF DA 5 PZ
	FRECCIA PROMOZIONALE "CONVIENE" IN PMMA SPESSORE 3 mm D: 44 x 14 H cm	CGPSLRV09	87	€ 55,94	CONF DA 5 PZ
	FRECCIA PROMOZIONALE "OFFERTA" IN PMMA SPESSORE 3 mm D: 44 x 14 H cm	CGPSLRFT02	87	€ 55,94	CONF DA 5 PZ
	FRECCIA PROMOZIONALE "OFFERTA ULTIMO MINUTO" IN PMMA SPESSORE 3 mm D: 44 x 14 H cm	CGPSLRUM03	87	€ 55,94	CONF DA 5 PZ

# COMUNICAZIONE PREZZO



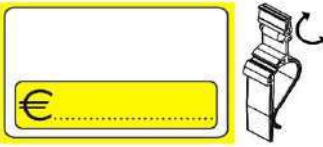
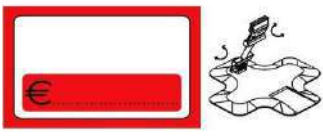

IMMAGINE	DESCRIZIONE	CODICE E COLORE	PAG CAT	PREZZO	NOTE
	PENNARELLO PER SEGNAPREZZI CON PUNTA A SEZIONE CIRCOLARE DA 5 mm 12 PZ	CPIPFC0101 CPIPFC0105	87	€ 63,30	CONF DA 12 PZ
	PENNARELLO PER SEGNAPREZZI CON PUNTA A SEZIONE CIRCOLARE DA 5 mm 1 PZ	CPIPFC0001 CPIPFC0005	87	€ 5,55	1 PZ
	PENNARELLO PER SEGNAPREZZI GESSO LIQUIDO D: 4,5 mm	CPIPFC0201	87	€ 4,13	1 PZ
	SEGNAPREZZO CANCELLABILE SERIE GAST D: 9,5 x 6,5 H cm	CPLAGT0102 CPLAGT0103 CPLAGT0106 CPLAGT0107	CAT 2017	€ 11,30	CONF DA 25 PZ
	SEGNAPREZZO CANCELLABILE SERIE GAST CON AGHI INOX E CLIP D: 9,5 x 6,5 H cm	CPLAGT0302 CPLAGT0303 CPLAGT0306 CPLAGT0307	CAT 2017	€ 36,39	CONF DA 25 PZ+1 PENN
	SEGNAPREZZO CANCELLABILE SERIE GAST CON AGHI DOPPIA PUNTA STANDARD D: 9,5 x 6,5 H cm	CPLAGT0702 CPLAGT0703 CPLAGT0706 CPLAGT0707	CAT 2017	€ 25,46	CONF DA 25 PZ+1 PENN

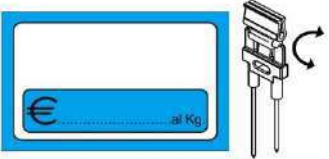



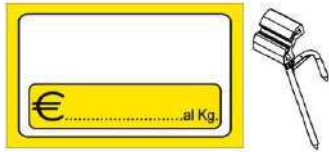
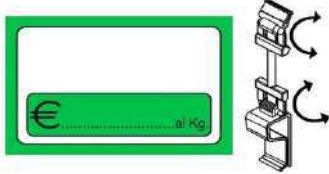

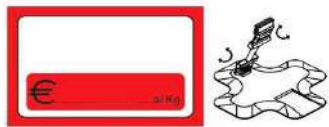
# COMUNICAZIONE PREZZO

IMMAGINE	DESCRIZIONE	CODICE E COLORE	PAG CAT	PREZZO	NOTE
	SEGNAPREZZO CANCELLABILE SERIE GAST CON MOLLETTA E ASTA 50 MM CON CLIP D: 9,5 x 6,5 H cm	CPLAGT0602 CPLAGT0603 CPLAGT0606 CPLAGT0607	CAT 2017	€ 38,52	CONF DA 25 PZ+1 PENN
	SEGNAPREZZO CANCELLABILE SERIE GAST CON MOLLETTA CON CLIP D: 9,5 x 6,5 H cm	CPLAGT1002 CPLAGT1003 CPLAGT1006 CPLAGT1007	CAT 2017	€ 33,30	CONF DA 25 PZ+1 PENN
	SEGNAPREZZO CANCELLABILE SERIE GAST CON BASI QUADRIFOGLIO E ASTA 50 MM CON CLIP D: 9,5 x 6,5 H cm	CPLAGT6002 CPLAGT6003 CPLAGT6006 CPLAGT6007	CAT 2017	€ 49,45	CONF DA 25 PZ+1 PENN
	SEGNAPREZZO CANCELLABILE SERIE GAST KG D: 9,5 X 6,5 H cm	CPLAGK0102 CPLAGK0103 CPLAGK0106 CPLAGK0107	CAT 2017	€ 11,30	CONF DA 25 PZ *ORDINE MINIMO 6 CONF
	SEGNAPREZZO CANCELLABILE SERIE GAST KG CON AGHI INOX CON CLIP D: 9,5 X 6,5 H cm	CPLAGK0302 CPLAGK0303 CPLAGK0306 CPLAGK0307	CAT 2017	€ 36,39	CONF DA 25 PZ *ORDINE MINIMO 6 CONF



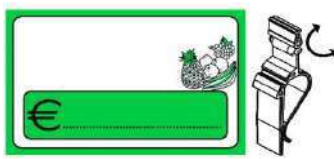
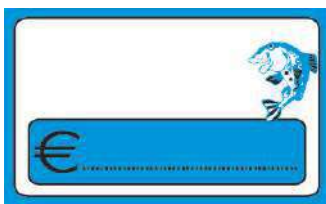

# COMUNICAZIONE PREZZO

IMMAGINE	DESCRIZIONE	CODICE E COLORE	PAG CAT	PREZZO	NOTE
	SEGNAPREZZO CANCELLABILE SERIE GAST KG CON AGHI DOPPIA PUNTA STANDARD D: 9,5 X 6,5 H cm	CPLAGK0702 CPLAGK0703 CPLAGK0706 CPLAGK0707	CAT 2017	€ 25,46	CONF DA 25 PZ *ORDINE MINIMO 6 CONF
	SEGNAPREZZO CANCELLABILE SERIE GAST KG CON MOLLETTA E ASTA 50 MM CON CLIP D: 9,5 X 6,5 H cm	CPLAGK0602 CPLAGK0603 CPLAGK0606 CPLAGK0607	CAT 2017	€ 38,52	CONF DA 25 PZ *ORDINE MINIMO 6 CONF
	SEGNAPREZZO CANCELLABILE SERIE GAST KG CON MOLLETTA CON CLIP D: 9,5 X 6,5 H cm	CPLAGK1002 CPLAGK1003 CPLAGK1006 CPLAGK1007	CAT 2017	€ 33,30	CONF DA 25 PZ *ORDINE MINIMO 6 CONF
	SEGNAPREZZO CANCELLABILE SERIE GAST KG CON BASI QUADRIFOGLIO E ASTA 50 MM CON CLIP D: 9,5 X 6,5 H cm	CPLAGK6002 CPLAGK6003 CPLAGK6006 CPLAGK6007	CAT 2017	€ 49,45	CONF DA 25 PZ *ORDINE MINIMO 6 CONF
	SEGNAPREZZO CANCELLABILE SERIE GAST FRUTTA D: 9,5 X 6,5 H cm	CPLAGF0107	CAT 2017	€ 11,30	CONF DA 25 PZ *ORDINE MINIMO 6 CONF



# COMUNICAZIONE PREZZO

IMMAGINE	DESCRIZIONE	CODICE E COLORE	PAG CAT	PREZZO	NOTE
	SEGNAPREZZO CANCELLABILE SERIE GAST FRUTTA CON ASTA TRIANGOLARE D: 9,5 X 6,5 H cm	CPLAGF0807	CAT 2017	€ 36,39	CONF DA 25 PZ+1 PENN *ORDINE MINIMO 6 CONF
	SEGNAPREZZO CANCELLABILE SERIE GAST FRUTTA CON MOLLETTA E ASTA 50 MM CON CLIP D: 9,5 X 6,5 H cm	CPLAGF0607	CAT 2017	€ 38,52	CONF DA 25 PZ+1 PENN *ORDINE MINIMO 6 CONF
	SEGNAPREZZO CANCELLABILE SERIE GAST FRUTTA CON MOLLETTA CON CLIP D: 9,5 X 6,5 H cm	CPLAGF1007	CAT 2017	€ 33,30	CONF DA 25 PZ+1 PENN *ORDINE MINIMO 6 CONF
	SEGNAPREZZO CANCELLABILE SERIE GAST PESCE D: 9,5 X 6,5 H cm	CPLAGP0102	CAT 2017	€ 11,30	CONF DA 25 PZ *ORDINE MINIMO 6 CONF
	SEGNAPREZZO CANCELLABILE SERIE GAST PESCE CON AGHI INOX CON CLIP D: 9,5 X 6,5 H cm	CPLAGP0302	CAT 2017	€ 36,39	CONF DA 25 PZ+1 PENN *ORDINE MINIMO 6 CONF



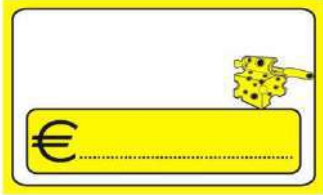
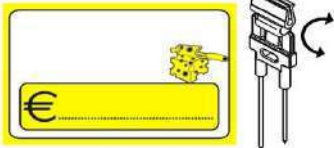

# COMUNICAZIONE PREZZO

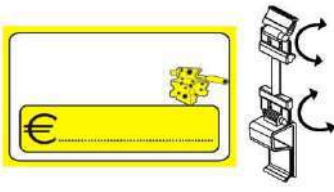
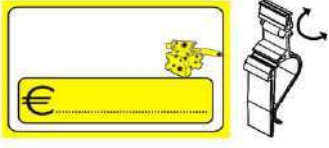
IMMAGINE	DESCRIZIONE	CODICE E COLORE	PAG CAT	PREZZO	NOTE
	SEGNAPREZZO CANCELLABILE SERIE GAST PESCE CON AGHI DOPPIA PUNTA STANDARD D: 9,5 X 6,5 H cm	CPLAGP0702	CAT 2017	€ 25,46	CONF DA 25 PZ+1 PENN *ORDINE MINIMO 6 CONF
	SEGNAPREZZO CANCELLABILE SERIE GAST PESCE CON ASTA TRIANGOLARE D: 9,5 X 6,5 H cm	CPLAGP0802	CAT 2017	€ 36,39	CONF DA 25 PZ+1 PENN *ORDINE MINIMO 6 CONF
	SEGNAPREZZO CANCELLABILE SERIE GAST PESCE CON MOLLETTA E ASTA 50 MM CON CLIP D: 9,5 X 6,5 H cm	CPLAGP0602	CAT 2017	€ 38,52	CONF DA 25 PZ+1 PENN *ORDINE MINIMO 6 CONF
	SEGNAPREZZO CANCELLABILE SERIE GAST PESCE CON MOLLETTA CON CLIP D: 9,5 X 6,5 H cm	CPLAGP1002	CAT 2017	€ 33,30	CONF DA 25 PZ+1 PENN *ORDINE MINIMO 6 CONF
	SEGNAPREZZO CANCELLABILE SERIE GAST PESCE CON ASTA GHIACCIO D: 9,5 X 6,5 H cm	CPLAGP1102	CAT 2017	€ 34,15	CONF DA 25 PZ+1 PENN *ORDINE MINIMO 6 CONF

# COMUNICAZIONE PREZZO

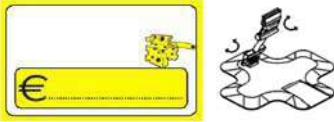
IMMAGINE	DESCRIZIONE	CODICE E COLORE	PAG CAT	PREZZO	NOTE
	SEGNAPREZZO CANCELLABILE SERIE GAST FORMAGGIO D: 9,5 X 6,5 H cm	CPLAGC0103	CAT 2017	€ 11,30	CONF DA 25 PZ *ORDINE MINIMO 6 CONF
	SEGNAPREZZO CANCELLABILE SERIE GAST FORMAGGIO CON AGHI INOX CON CLIP D: 9,5 X 6,5 H cm	CPLAGC0303	CAT 2017	€ 36,39	CONF DA 25 PZ+1 PENN *ORDINE MINIMO 6 CONF
	SEGNAPREZZO CANCELLABILE SERIE GAST FORMAGGIO CON AGHI DOPPIA PUNTA STANDARD D: 9,5 X 6,5 H cm	CPLAGC0703	CAT 2017	€ 25,46	CONF DA 25 PZ+1 PENN *ORDINE MINIMO 6 CONF
	SEGNAPREZZO CANCELLABILE SERIE GAST FORMAGGIO CON MOLLETTA E ASTA 50 MM CON CLIP D: 9,5 X 6,5 H cm	CPLAGC0603	CAT 2017	€ 38,52	CONF DA 25 PZ+1 PENN *ORDINE MINIMO 6 CONF
	SEGNAPREZZO CANCELLABILE SERIE GAST FORMAGGIO CON MOLLETTA CON CLIP D: 9,5 X 6,5 H cm	CPLAGC1003	CAT 2017	€ 33,30	CONF DA 25 PZ+1 PENN *ORDINE MINIMO 6 CONF



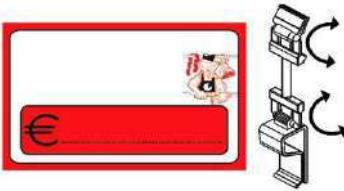

# COMUNICAZIONE PREZZO

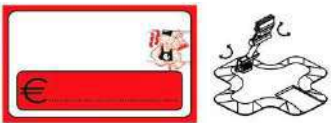
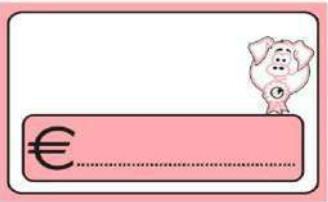
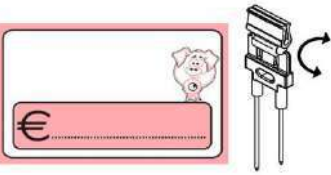
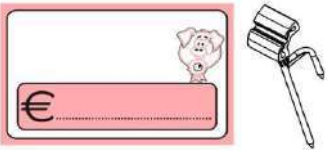
IMMAGINE	DESCRIZIONE	CODICE E COLORE	PAG CAT	PREZZO	NOTE
	SEGNAPREZZO CANCELLABILE SERIE GAST FORMAGGIO CON BASI QUADRIFOGLIO E ASTA 50 MM CON CLIP D: 9,5 X 6,5 H cm	CPLAGC6003	CAT 2017	€ 49,45	CONF DA 25 PZ+1 PENN *ORDINE MINIMO 6 CONF
	SEGNAPREZZO CANCELLABILE SERIE GAST SALUMI D: 9,5 X 6,5 H cm	CPLAGS0106	CAT 2017	€ 11,30	CONF DA 25 PZ *ORDINE MINIMO 6 CONF
	SEGNAPREZZO CANCELLABILE SERIE GAST SALUMI CON AGHI INOX CON CLIP D: 9,5 X 6,5 H cm	CPLAGS0306	CAT 2017	€ 36,39	CONF DA 25 PZ+1 PENN *ORDINE MINIMO 6 CONF
	SEGNAPREZZO CANCELLABILE SERIE GAST SALUMI CON AGHI DOPPIA PUNTA STANDARD D: 9,5 X 6,5 H cm	CPLAGS0706	CAT 2017	€ 25,46	CONF DA 25 PZ+1 PENN *ORDINE MINIMO 6 CONF
	SEGNAPREZZO CANCELLABILE SERIE GAST SALUMI CON MOLLETTA E ASTA 50 MM CON CLIP D: 9,5 X 6,5 H cm	CPLAGS0606	CAT 2017	€ 38,52	CONF DA 25 PZ+1 PENN *ORDINE MINIMO 6 CONF

# COMUNICAZIONE PREZZO

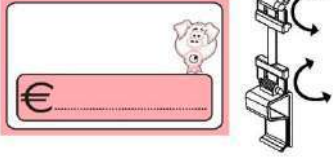
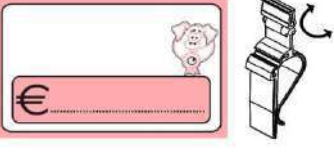

IMMAGINE	DESCRIZIONE	CODICE E COLORE	PAG CAT	PREZZO	NOTE
	SEGNAPREZZO CANCELLABILE SERIE GAST SALUMI CON MOLLETTA CON CLIP D: 9,5 X 6,5 H cm	CPLAGS1006	CAT 2017	€ 33,30	CONF DA 25 PZ+1 PENN *ORDINE MINIMO 6 CONF
	SEGNAPREZZO CANCELLABILE SERIE GAST SALUMI CON BASI QUADRIFOGLIO E ASTA 50 MM CON CLIP D: 9,5 X 6,5 H cm	CPLAGS6006	CAT 2017	€ 49,45	CONF DA 25 PZ+1 PENN *ORDINE MINIMO 6 CONF
	SEGNAPREZZO CANCELLABILE SERIE GAST SUINO D: 9,5 X 6,5 H cm	CPLAGM0124	CAT 2017	€ 11,30	CONF DA 25 PZ *ORDINE MINIMO 6 CONF
	SEGNAPREZZO CANCELLABILE SERIE GAST SUINO CON AGHI INOX CON CLIP D: 9,5 X 6,5 H cm	CPLAGU0324	CAT 2017	€ 36,39	CONF DA 25 PZ+1 PENN *ORDINE MINIMO 6 CONF
	SEGNAPREZZO CANCELLABILE SERIE GAST SUINO CON AGHI DOPPIA PUNTA STANDARD D: 9,5 X 6,5 H cm	CPLAGU0724	CAT 2017	€ 25,46	CONF DA 25 PZ+1 PENN *ORDINE MINIMO 6 CONF

# COMUNICAZIONE PREZZO



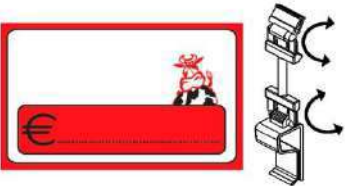

IMMAGINE	DESCRIZIONE	CODICE E COLORE	PAG CAT	PREZZO	NOTE
	SEGNAPREZZO CANCELLABILE SERIE GAST SUINO CON MOLLETTA E ASTA 50 MM CON CLIP D: 9,5 X 6,5 H cm	CPLAGU0624	CAT 2017	€ 38,52	CONF DA 25 PZ+1 PENN *ORDINE MINIMO 6 CONF
	SEGNAPREZZO CANCELLABILE SERIE GAST SUINO CON MOLLETTA CON CLIP D: 9,5 X 6,5 H cm	CPLAGU1024	CAT 2017	€ 33,30	CONF DA 25 PZ+1 PENN *ORDINE MINIMO 6 CONF
	SEGNAPREZZO CANCELLABILE SERIE GAST SUINO CON BASI QUADRIFOGLIO CON ASTA 50 MM CON CLIP D: 9,5 X 6,5 H cm	CPLAGU6024	CAT 2017	€ 49,45	CONF DA 25 PZ+1 PENN *ORDINE MINIMO 6 CONF
	SEGNAPREZZO CANCELLABILE SERIE GAST MACELLERIA D: 9,5 X 6,5 H cm	CPLAGM0106	CAT 2017	€ 11,30	CONF DA 25 PZ *ORDINE MINIMO 6 CONF
	SEGNAPREZZO CANCELLABILE SERIE GAST MACELLERIA CON AGHI INOX CON CLIP D: 9,5 X 6,5 H cm	CPLAGM0306	CAT 2017	€ 36,39	CONF DA 25 PZ+1 PENN *ORDINE MINIMO 6 CONF

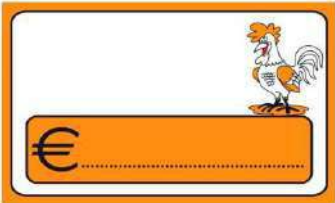



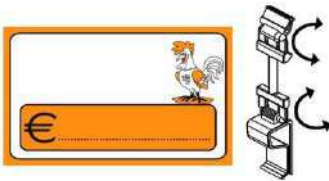

# COMUNICAZIONE PREZZO

IMMAGINE	DESCRIZIONE	CODICE E COLORE	PAG CAT	PREZZO	NOTE
	SEGNAPREZZO CANCELLABILE SERIE GAST MACELLERIA CON AGHI DOPPIA PUNTA STANDARD D: 9,5 X 6,5 H cm	CPLAGM0706	CAT 2017	€ 25,46	CONF DA 25 PZ+1 PENN *ORDINE MINIMO 6 CONF
	SEGNAPREZZO CANCELLABILE SERIE GAST MACELLERIA CON MOLLETTA E ASTA 50 MM CON CLIP D: 9,5 X 6,5 H cm	CPLAGM0606	CAT 2017	€ 38,52	CONF DA 25 PZ+1 PENN *ORDINE MINIMO 6 CONF
	SEGNAPREZZO CANCELLABILE SERIE GAST MACELLERIA CON MOLLETTA CON CLIP D: 9,5 X 6,5 H cm	CPLAGM1006	CAT 2017	€ 33,30	CONF DA 25 PZ+1 PENN *ORDINE MINIMO 6 CONF
	SEGNAPREZZO CANCELLABILE SERIE GAST MACELLERIA CON BASI QUADRIFOGLIO CON ASTA 50 MM CON CLIP D: 9,5 X 6,5 H cm	CPLAGM6006	CAT 2017	€ 49,45	CONF DA 25 PZ+1 PENN *ORDINE MINIMO 6 CONF
	SEGNAPREZZO CANCELLABILE SERIE GAST POLLO D: 9,5 X 6,5 H cm	CPLAGL0109	CAT 2017	€ 11,30	CONF DA 25 PZ *ORDINE MINIMO 6 CONF

# COMUNICAZIONE PREZZO

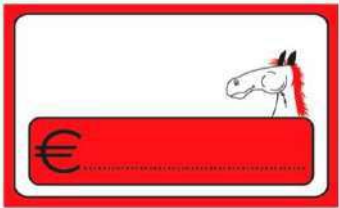
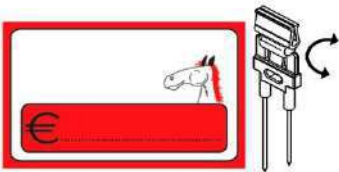
IMMAGINE	DESCRIZIONE	CODICE E COLORE	PAG CAT	PREZZO	NOTE
	SEGNAPREZZO CANCELLABILE SERIE GAST POLLO CON AGHI INOX CON CLIP D: 9,5 X 6,5 H cm	CPLAGL0309	CAT 2017	€ 36,39	CONF DA 25 PZ+1 PENN *ORDINE MINIMO 6 CONF
	SEGNAPREZZO CANCELLABILE SERIE GAST POLLO CON AGHI DOPPIA PUNTA STANDARD D: 9,5 X 6,5 H cm	CPLAGL0709	CAT 2017	€ 25,46	CONF DA 25 PZ+1 PENN *ORDINE MINIMO 6 CONF
	SEGNAPREZZO CANCELLABILE SERIE GAST POLLO CON MOLLETTA E ASTA 50 MM CON CLIP D: 9,5 X 6,5 H cm	CPLAGL0609	CAT 2017	€ 38,52	CONF DA 25 PZ+1 PENN *ORDINE MINIMO 6 CONF
	SEGNAPREZZO CANCELLABILE SERIE GAST POLLO CON MOLLETTA CON CLIP D: 9,5 X 6,5 H cm	CPLAGL1009	CAT 2017	€ 33,30	CONF DA 25 PZ+1 PENN *ORDINE MINIMO 6 CONF
	SEGNAPREZZO CANCELLABILE SERIE GAST POLLO CON BASI QUADRIFOGLIO E ASTA 50 MM CON CLIP D: 9,5 X 6,5 H cm	CPLAGL6009	CAT 2017	€ 49,45	CONF DA 25 PZ+1 PENN *ORDINE MINIMO 6 CONF

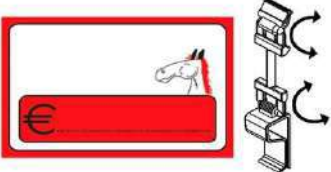

# COMUNICAZIONE PREZZO

IMMAGINE	DESCRIZIONE	CODICE E COLORE	PAG CAT	PREZZO	NOTE
	SEGNAPREZZO CANCELLABILE SERIE GAST CAVALLO D: 9,5 X 6,5 H cm	CPLAGH0106	CAT 2017	€ 11,30	CONF DA 25 PZ *ORDINE MINIMO 6 CONF
	SEGNAPREZZO CANCELLABILE SERIE GAST CAVALLO CON AGHI INOX CON CLIP D: 9,5 X 6,5 H cm	CPLAGH0306	CAT 2017	€ 36,39	CONF DA 25 PZ+1 PENN *ORDINE MINIMO 6 CONF
	SEGNAPREZZO CANCELLABILE SERIE GAST CAVALLO CON AGHI DOPPIA PUNTA STANDARD D: 9,5 X 6,5 H cm	CPLAGH0706	CAT 2017	€ 25,46	CONF DA 25 PZ+1 PENN *ORDINE MINIMO 6 CONF
	SEGNAPREZZO CANCELLABILE SERIE GAST CAVALLO CON MOLLETTA E ASTA 50 MM CON CLIP D: 9,5 X 6,5 H cm	CPLAGH0606	CAT 2017	€ 38,52	CONF DA 25 PZ+1 PENN *ORDINE MINIMO 6 CONF
	SEGNAPREZZO CANCELLABILE SERIE GAST CAVALLO CON MOLLETTA CON CLIP D: 9,5 X 6,5 H cm	CPLAGH1006	CAT 2017	€ 33,30	CONF DA 25 PZ+1 PENN *ORDINE MINIMO 6 CONF

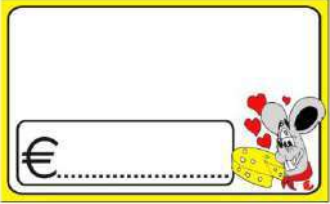
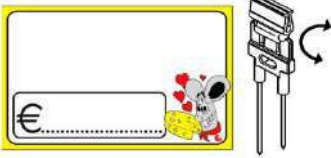
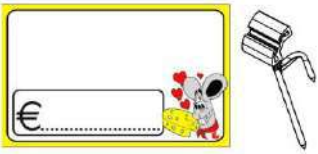
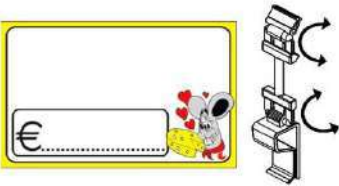

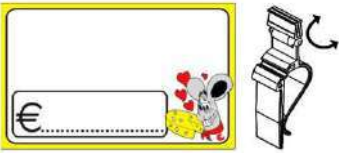
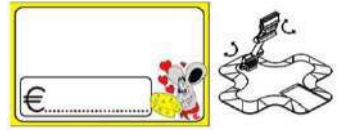
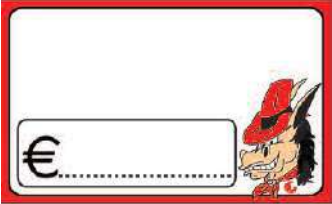

# COMUNICAZIONE PREZZO

IMMAGINE	DESCRIZIONE	CODICE E COLORE	PAG CAT	PREZZO	NOTE
	SEGNAPREZZO CANCELLABILE SERIE GAST CAVALLO CON BASI QUADRIFOGLIO E ASTA 50 MM CON CLIP D: 9,5 X 6,5 H cm	CPLAGH6006	CAT 2017	€ 49,45	CONF DA 25 PZ+1 PENN *ORDINE MINIMO 6 CONF
	SEGNAPREZZO CANCELLABILE SERIE "R" FORMAGGIO D: 9,5 X 6,5 H cm	CPLARC0103	CAT 2017	€ 11,30	CONF DA 25 PZ *ORDINE MINIMO 6 CONF
	SEGNAPREZZO CANCELLABILE SERIE "R" FORMAGGIO CON AGHI INOX CON CLIP D: 9,5 X 6,5 H cm	CPLARC0303	CAT 2017	€ 36,39	CONF DA 25 PZ+1 PENN *ORDINE MINIMO 6 CONF
	SEGNAPREZZO CANCELLABILE SERIE "R" FORMAGGIO CON AGHI DOPPIA PUNTA STANDARD D: 9,5 X 6,5 H cm	CPLARC0703	CAT 2017	€ 25,46	CONF DA 25 PZ+1 PENN *ORDINE MINIMO 6 CONF
	SEGNAPREZZO CANCELLABILE SERIE "R" FORMAGGIO CON MOLLETTA E ASTA 50 MM CON CLIP D: 9,5 X 6,5 H cm	CPLARC0603	CAT 2017	€ 38,52	CONF DA 25 PZ+1 PENN *ORDINE MINIMO 6 CONF



# COMUNICAZIONE PREZZO

IMMAGINE	DESCRIZIONE	CODICE E COLORE	PAG CAT	PREZZO	NOTE
	SEGNAPREZZO CANCELLABILE SERIE "R" FORMAGGIO CON MOLLETTA CON CLIP D: 9,5 X 6,5 H cm	CPLARC1003	CAT 2017	€ 33,30	CONF DA 25 PZ+1 PENN *ORDINE MINIMO 6 CONF
	SEGNAPREZZO CANCELLABILE SERIE "R" FORMAGGIO CON BASI QUADRIFOGLIO E ASTA 50 MM CON CLIP D: 9,5 X 6,5 H cm	CPLARC6003	CAT 2017	€ 49,45	CONF DA 25 PZ+1 PENN *ORDINE MINIMO 6 CONF
	SEGNAPREZZO CANCELLABILE SERIE "R" EQUINO D: 9,5 X 6,5 H cm	CPLARH0106	CAT 2017	€ 11,30	CONF DA 25 PZ *ORDINE MINIMO 6 CONF
	SEGNAPREZZO CANCELLABILE SERIE "R" EQUINO CON AGHI INOX CON CLIP D: 9,5 X 6,5 H cm	CPLARH0306	CAT 2017	€ 36,39	CONF DA 25 PZ+1 PENN *ORDINE MINIMO 6 CONF
	SEGNAPREZZO CANCELLABILE SERIE "R" EQUINO CON AGHI DOPPIA PUNTA STANDARD D: 9,5 X 6,5 H cm	CPLARH0706	CAT 2017	€ 25,46	CONF DA 25 PZ+1 PENN *ORDINE MINIMO 6 CONF

# COMUNICAZIONE PREZZO

IMMAGINE	DESCRIZIONE	CODICE E COLORE	PAG CAT	PREZZO	NOTE
	SEGNAPREZZO CANCELLABILE SERIE "R" EQUINO CON MOLLETTA E ASTA 50 MM CON CLIP D: 9,5 X 6,5 H cm	CPLARH0606	CAT 2017	€ 38,52	CONF DA 25 PZ+1 PENN *ORDINE MINIMO 6 CONF
	SEGNAPREZZO CANCELLABILE SERIE "R" EQUINO CON MOLLETTA CON CLIP D: 9,5 X 6,5 H cm	CPLARH1006	CAT 2017	€ 33,30	CONF DA 25 PZ+1 PENN *ORDINE MINIMO 6 CONF
	SEGNAPREZZO CANCELLABILE SERIE "R" EQUINO CON BASI QUADRIFOGLIO E ASTA 50 MM CON CLIP D: 9,5 X 6,5 H cm	CPLARH6006	CAT 2017	€ 49,45	CONF DA 25 PZ+1 PENN *ORDINE MINIMO 6 CONF
	SEGNAPREZZO CANCELLABILE SERIE "R" SALUMI D: 9,5 X 6,5 H cm	CPLARS0106	CAT 2017	€ 11,30	CONF DA 25 PZ *ORDINE MINIMO 6 CONF
	SEGNAPREZZO CANCELLABILE SERIE "R" SALUMI CON AGHI INOX CON CLIP D: 9,5 X 6,5 H cm	CPLARS0306	CAT 2017	€ 36,39	CONF DA 25 PZ+1 PENN *ORDINE MINIMO 6 CONF

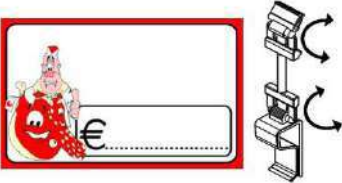
# COMUNICAZIONE PREZZO

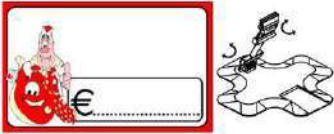
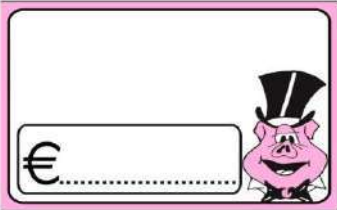
IMMAGINE	DESCRIZIONE	CODICE E COLORE	PAG CAT	PREZZO	NOTE
	SEGNAPREZZO CANCELLABILE SERIE "R" SALUMI CON AGHI DOPPIA PUNTA STANDARD D: 9,5 X 6,5 H cm	CPLARS0706	CAT 2017	€ 25,46	CONF DA 25 PZ+1 PENN *ORDINE MINIMO 6 CONF
	SEGNAPREZZO CANCELLABILE SERIE "R" SALUMI CON MOLLETTA E ASTA 50 MM CON CLIP D: 9,5 X 6,5 H cm	CPLARS0606	CAT 2017	€ 38,52	CONF DA 25 PZ+1 PENN *ORDINE MINIMO 6 CONF
	SEGNAPREZZO CANCELLABILE SERIE "R" SALUMI CON MOLLETTA CON CLIP D: 9,5 X 6,5 H cm	CPLARS1006	CAT 2017	€ 33,30	CONF DA 25 PZ+1 PENN *ORDINE MINIMO 6 CONF
	SEGNAPREZZO CANCELLABILE SERIE "R" SALUMI CON BASI QUADRIFOGLIO E ASTA 50 MM CON CLIP D: 9,5 X 6,5 H cm	CPLARS6006	CAT 2017	€ 49,45	CONF DA 25 PZ+1 PENN *ORDINE MINIMO 6 CONF
	SEGNAPREZZO CANCELLABILE SERIE "R" SUINO D: 9,5 X 6,5 H cm	CPLARU0124	CAT 2017	€ 11,30	CONF DA 25 PZ *ORDINE MINIMO 6 CONF

# COMUNICAZIONE PREZZO

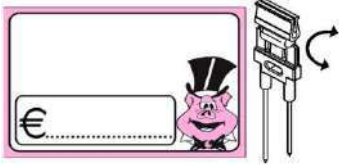
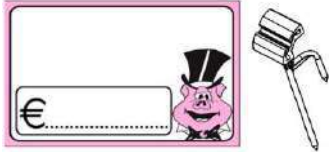
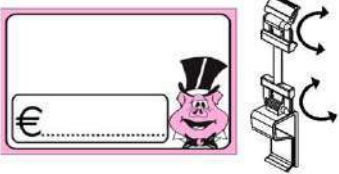
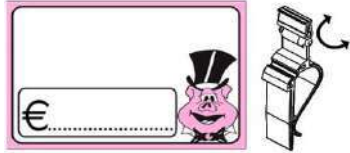
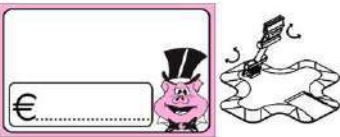



IMMAGINE	DESCRIZIONE	CODICE E COLORE	PAG CAT	PREZZO	NOTE
	SEGNAPREZZO CANCELLABILE SERIE "R" SUINO CON AGHI INOX CON CLIP D: 9,5 X 6,5 H cm	CPLARU0324	CAT 2017	€ 36,39	CONF DA 25 PZ+1 PENN *ORDINE MINIMO 6 CONF
	SEGNAPREZZO CANCELLABILE SERIE "R" SUINO CON AGHI DOPPIA PUNTA STANDARD D: 9,5 X 6,5 H cm	CPLARU0724	CAT 2017	€ 25,46	CONF DA 25 PZ+1 PENN *ORDINE MINIMO 6 CONF
	SEGNAPREZZO CANCELLABILE SERIE "R" SUINO CON MOLLETTA E ASTA 50 MM CON CLIP D: 9,5 X 6,5 H cm	CPLARU0624	CAT 2017	€ 38,52	CONF DA 25 PZ+1 PENN *ORDINE MINIMO 6 CONF
	SEGNAPREZZO CANCELLABILE SERIE "R" SUINO CON MOLLETTA CON CLIP D: 9,5 X 6,5 H cm	CPLARU1024	CAT 2017	€ 33,30	CONF DA 25 PZ+1 PENN *ORDINE MINIMO 6 CONF
	SEGNAPREZZO CANCELLABILE SERIE "R" SUINO CON BASIQUADRIFOGLIO E ASTA 50 MM CON CLIP D: 9,5 X 6,5 H cm	CPLARU6024	CAT 2017	€ 49,45	CONF DA 25 PZ+1 PENN *ORDINE MINIMO 6 CONF

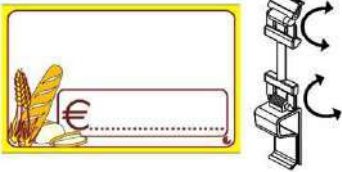
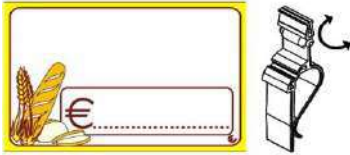
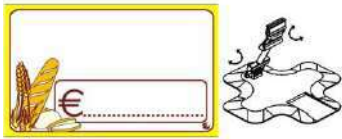
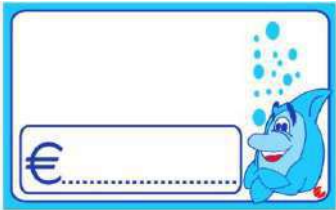

# COMUNICAZIONE PREZZO

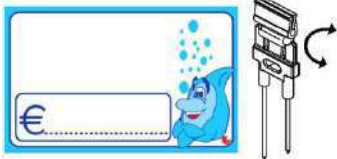
IMMAGINE	DESCRIZIONE	CODICE E COLORE	PAG CAT	PREZZO	NOTE
	SEGNAPREZZO CANCELLABILE SERIE "R" PANE D: 9,5 X 65 H cm	CPLARB0103	CAT 2017	€ 11,30	CONF DA 25 PZ *ORDINE MINIMO 6 CONF
	SEGNAPREZZO CANCELLABILE SERIE "R" PANE CON MOLLETTE E ASTE 50 MM CON CLIP D: 9,5 X 65 H cm	CPLARB0603	CAT 2017	€ 38,52	CONF DA 25 PZ+1 PENN *ORDINE MINIMO 6 CONF
	SEGNAPREZZO CANCELLABILE SERIE "R" PANE CON MOLLETTE CON CLIP D: 9,5 X 65 H cm	CPLARB1003	CAT 2017	€ 33,30	CONF DA 25 PZ+1 PENN *ORDINE MINIMO 6 CONF
	SEGNAPREZZO CANCELLABILE SERIE "R" PANE CON BASI QUADRIFOGLIO E ASTE 50 MM CON CLIP D: 9,5 X 65 H cm	CPLARB6003	CAT 2017	€ 49,45	CONF DA 25 PZ+1 PENN *ORDINE MINIMO 6 CONF
	SEGNAPREZZO CANCELLABILE SERIE "R" PESCE D: 9,5 X 6,5 H cm	CPLARP0102	CAT 2017	€ 11,30	CONF DA 25 PZ *ORDINE MINIMO 6 CONF

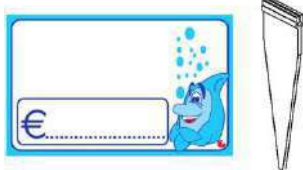
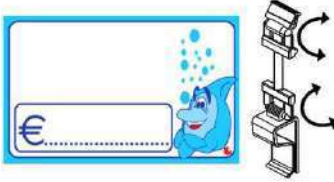

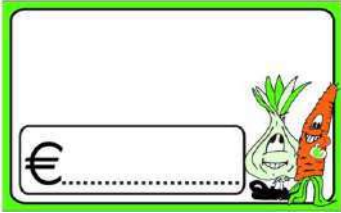
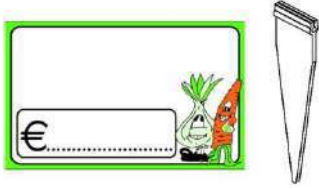
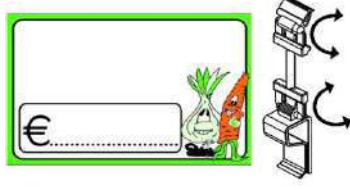
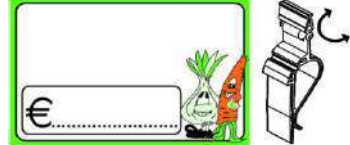

# COMUNICAZIONE PREZZO

IMMAGINE	DESCRIZIONE	CODICE E COLORE	PAG CAT	PREZZO	NOTE
	SEGNAPREZZO CANCELLABILE SERIE "R" PESCE CON AGHI INOX CON CLIP D: 9,5 X 6,5 H cm	CPLARP0302	CAT 2017	€ 36,39	CONF DA 25 PZ+1 PENN *ORDINE MINIMO 6 CONF
	SEGNAPREZZO CANCELLABILE SERIE "R" PESCE CON AGHI DOPPIA PUNTA STANDARD D: 9,5 X 6,5 H cm	CPLARP0702	CAT 2017	€ 25,46	CONF DA 25 PZ+1 PENN *ORDINE MINIMO 6 CONF
	SEGNAPREZZO CANCELLABILE SERIE "R" PESCE CON ASTA TRIANGOLARE D: 9,5 X 6,5 H cm	CPLARP0802	CAT 2017	€ 26,41	CONF DA 25 PZ+1 PENN *ORDINE MINIMO 6 CONF
	SEGNAPREZZO CANCELLABILE SERIE "R" PESCE CON MOLLETTE E ASTE 50 MM CON CLIP D: 9,5 X 6,5 H cm	CPLARP0602	CAT 2017	€ 38,52	CONF DA 25 PZ+1 PENN *ORDINE MINIMO 6 CONF
	SEGNAPREZZO CANCELLABILE SERIE "R" PESCE CON MOLLETTE CON CLIP D: 9,5 X 6,5 H cm	CPLARP1002	CAT 2017	€ 33,30	CONF DA 25 PZ+1 PENN *ORDINE MINIMO 6 CONF



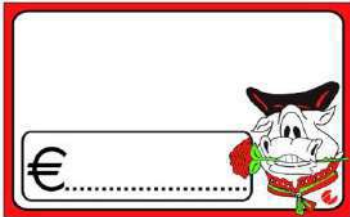

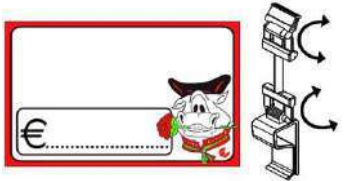
# COMUNICAZIONE PREZZO

IMMAGINE	DESCRIZIONE	CODICE E COLORE	PAG CAT	PREZZO	NOTE
	SEGNAPREZZO CANCELLABILE SERIE "R" PESCE CON ASTA GHIACCIO D: 9,5 X 6,5 H cm	CPLARP1102	CAT 2017	€ 34,15	CONF DA 25 PZ+1 PENN *ORDINE MINIMO 6 CONF
	SEGNAPREZZO CANCELLABILE SERIE "R" FRUTTA D: 9,5 X 6,5 H cm	CPLARF0107	CAT 2017	€ 11,30	CONF DA 25 PZ *ORDINE MINIMO 6 CONF
	SEGNAPREZZO CANCELLABILE SERIE "R" FRUTTA CON ASTA TRIANGOLARE D: 9,5 X 6,5 H cm	CPLARF0807	CAT 2017	€ 26,41	CONF DA 25 PZ+1 PENN *ORDINE MINIMO 6 CONF
	SEGNAPREZZO CANCELLABILE SERIE "R" FRUTTA CON MOLLETTE E ASTE 50 MM CON CLIP D: 9,5 X 6,5 H cm	CPLARF0607	CAT 2017	€ 38,52	CONF DA 25 PZ+1 PENN *ORDINE MINIMO 6 CONF
	SEGNAPREZZO CANCELLABILE SERIE "R" FRUTTA CON MOLLETTE CON CLIP D: 9,5 X 6,5 H cm	CPLARF1007	CAT 2017	€ 33,30	CONF DA 25 PZ+1 PENN *ORDINE MINIMO 6 CONF



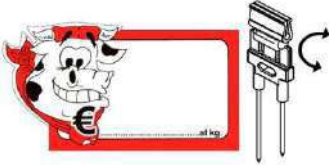

# COMUNICAZIONE PREZZO

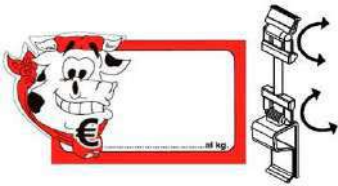
IMMAGINE	DESCRIZIONE	CODICE E COLORE	PAG CAT	PREZZO	NOTE
	SEGNAPREZZO CANCELLABILE SERIE "R" MACELLERIA D: 9,5 X 6,5 H cm	CPLARM0106	CAT 2017	€ 11,30	CONF DA 25 PZ *ORDINE MINIMO 6 CONF
	SEGNAPREZZO CANCELLABILE SERIE "R" MACELLERIA CON AGHI INOX CON CLIP D: 9,5 X 6,5 H cm	CPLARM0306	CAT 2017	€ 36,39	CONF DA 25 PZ+1 PENN *ORDINE MINIMO 6 CONF
	SEGNAPREZZO CANCELLABILE SERIE "R" MACELLERIA CON AGHI DOPPIA PUNTA STANDARD D: 9,5 X 6,5 H cm	CPLARM0706	CAT 2017	€ 25,46	CONF DA 25 PZ+1 PENN *ORDINE MINIMO 6 CONF
	SEGNAPREZZO CANCELLABILE SERIE "R" MACELLERIA CON MOLLETTE E ASTE 50 MM CON CLIP D: 9,5 X 6,5 H cm	CPLARM0606	CAT 2017	€ 38,52	CONF DA 25 PZ+1 PENN *ORDINE MINIMO 6 CONF
	SEGNAPREZZO CANCELLABILE SERIE "R" MACELLERIA CON MOLLETTE CON CLIP D: 9,5 X 6,5 H cm	CPLARM1006	CAT 2017	€ 33,30	CONF DA 25 PZ+1 PENN *ORDINE MINIMO 6 CONF

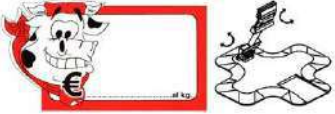

# COMUNICAZIONE PREZZO

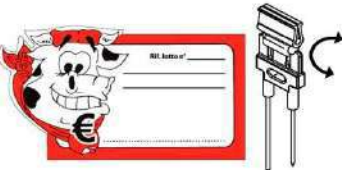
IMMAGINE	DESCRIZIONE	CODICE E COLORE	PAG CAT	PREZZO	NOTE
	SEGNAPREZZO CANCELLABILE SERIE "R" MACELLERIA CON BASI QUADRIFOGLIO E ASTE 50 MM CON CLIP D: 9,5 X 6,5 H cm	CPLARM6006	CAT 2017	€ 49,45	CONF DA 25 PZ+1 PENN *ORDINE MINIMO 6 CONF
	SEGNAPREZZO CANCELLABILE SERIE "F" MACELLERIA NEUTRA D: 15 x 8 H cm	CPLAFM0106	CAT 2017	€ 13,54	CONF DA 25 PZ *ORDINE MINIMO 6 CONF
	SEGNAPREZZO CANCELLABILE SERIE "F" MACELLERIA NEUTRA CON AGHI INOX CON CLIP D: 15 x 8 H cm	CPLAFM0306	CAT 2017	€ 38,51	CONF DA 25 PZ+1 PENN *ORDINE MINIMO 6 CONF
	SEGNAPREZZO CANCELLABILE SERIE "F" MACELLERIA NEUTRA CON AGHI DOPPIA PUNTA STANDARD D: 15 x 8 H cm	CPLAFM0706	CAT 2017	€ 27,59	CONF DA 25 PZ+1 PENN *ORDINE MINIMO 6 CONF
	SEGNAPREZZO CANCELLABILE SERIE "F" MACELLERIA NEUTRA CON MOLLETTE E ASTE 50 MM CON CLIP D: 15 x 8 H cm	CPLAFM0606	CAT 2017	€ 40,65	CONF DA 25 PZ+1 PENN *ORDINE MINIMO 6 CONF



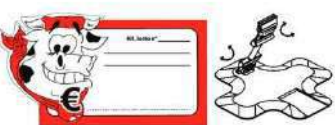
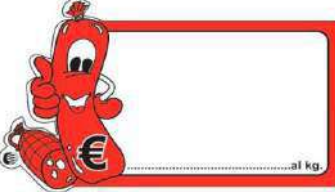
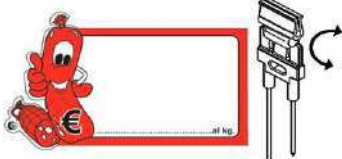

# COMUNICAZIONE PREZZO

IMMAGINE	DESCRIZIONE	CODICE E COLORE	PAG CAT	PREZZO	NOTE
	SEGNAPREZZO CANCELLABILE SERIE "F" MACELLERIA NEUTRA CON MOLLETTE CON CLIP D: 15 x 8 H cm	CPLAFM1006	CAT 2017	€ 35,43	CONF DA 25 PZ+1 PENN *ORDINE MINIMO 6 CONF
	SEGNAPREZZO CANCELLABILE SERIE "F" MACELLERIA NEUTRA CON BASI QUADRIFOGLIO E ASTE 50 MM CON CLIP D: 15 x 8 H cm	CPLAFM6006	CAT 2017	€ 51,58	CONF DA 25 PZ+1 PENN *ORDINE MINIMO 6 CONF
	SEGNAPREZZO CANCELLABILE SERIE "F" MACELLERIA LOTTO D: 15 X 8 H cm	CPLAFL0106	CAT 2017	€ 13,54	CONF DA 25 PZ *ORDINE MINIMO 6 CONF
	SEGNAPREZZO CANCELLABILE SERIE "F" MACELLERIA LOTTO CON AGHI INOX CON CLIP D: 15 X 8 H cm	CPLAFL0306	CAT 2017	€ 38,51	CONF DA 25 PZ+1 PENN *ORDINE MINIMO 6 CONF
	SEGNAPREZZO CANCELLABILE SERIE "F" MACELLERIA LOTTO CON AGHI DOPPIA PUNTA STANDARD D: 15 X 8 H cm	CPLAFL0706	CAT 2017	€ 27,59	CONF DA 25 PZ+1 PENN *ORDINE MINIMO 6 CONF

# COMUNICAZIONE PREZZO

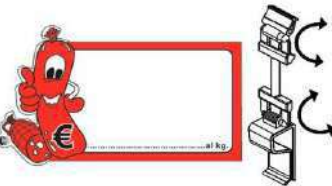

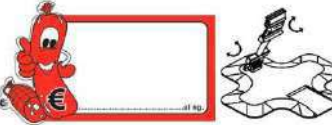

IMMAGINE	DESCRIZIONE	CODICE E COLORE	PAG CAT	PREZZO	NOTE
	SEGNAPREZZO CANCELLABILE SERIE "F" MACELLERIA LOTTO CON MOLLETTE E ASTE 50 MM CON CLIP D: 15 X 8 H cm	CPLAFL0606	CAT 2017	€ 40,65	CONF DA 25 PZ+1 PENN *ORDINE MINIMO 6 CONF
	SEGNAPREZZO CANCELLABILE SERIE "F" MACELLERIA LOTTO CON MOLLETTE CON CLIP D: 15 X 8 H cm	CPLAFL1006	CAT 2017	€ 35,43	CONF DA 25 PZ+1 PENN *ORDINE MINIMO 6 CONF
	SEGNAPREZZO CANCELLABILE SERIE "F" MACELLERIA LOTTO CON BASI QUADRIFOGLIO E ASTE 50 MM CON CLIP D: 15 X 8 H cm	CPLAFL6006	CAT 2017	€ 51,58	CONF DA 25 PZ+1 PENN *ORDINE MINIMO 6 CONF
	SEGNAPREZZO CANCELLABILE SERIE "F" SALUMI D: 15 X 8 H cm	CPLAFS0106	CAT 2017	€ 13,54	CONF DA 25 PZ *ORDINE MINIMO 6 CONF
	SEGNAPREZZO CANCELLABILE SERIE "F" SALUMI CON AGHI INOX CON CLIP D: 15 X 8 H cm	CPLAFS0306	CAT 2017	€ 38,51	CONF DA 25 PZ+1 PENN *ORDINE MINIMO 6 CONF

# COMUNICAZIONE PREZZO

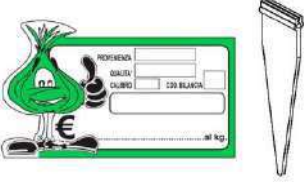
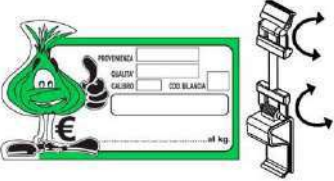

IMMAGINE	DESCRIZIONE	CODICE E COLORE	PAG CAT	PREZZO	NOTE
	SEGNAPREZZO CANCELLABILE SERIE "F" SALUMI CON AGHI DOPPIA PUNTA STANDARD D: 15 X 8 H cm	CPLAFS0706	CAT 2017	€ 27,59	CONF DA 25 PZ+1 PENN *ORDINE MINIMO 6 CONF
	SEGNAPREZZO CANCELLABILE SERIE "F" SALUMI CON MOLLETTE E ASTE 50 MM CON CLIP D: 15 X 8 H cm	CPLAFS0606	CAT 2017	€ 40,65	CONF DA 25 PZ+1 PENN *ORDINE MINIMO 6 CONF
	SEGNAPREZZO CANCELLABILE SERIE "F" SALUMI CON MOLLETTE CON CLIP D: 15 X 8 H cm	CPLAFS1006	CAT 2017	€ 35,43	CONF DA 25 PZ+1 PENN *ORDINE MINIMO 6 CONF
	SEGNAPREZZO CANCELLABILE SERIE "F" SALUMI CON BASI QUADRIFOGLIO E ASTE 50 MM CON CLIP D: 15 X 8 H cm	CPLAFS6006	CAT 2017	€ 51,58	CONF DA 25 PZ+1 PENN *ORDINE MINIMO 6 CONF
	SEGNAPREZZO CANCELLABILE SERIE "F" FRUTTA D: 15 X 8 H cm	CPLAFF0107	CAT 2017	€ 13,54	CONF DA 25 PZ *ORDINE MINIMO 6 CONF





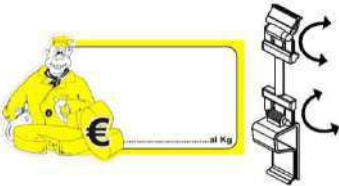

# COMUNICAZIONE PREZZO

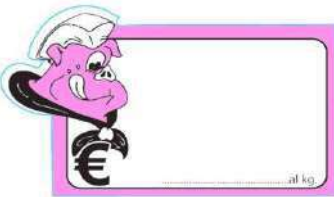
IMMAGINE	DESCRIZIONE	CODICE E COLORE	PAG CAT	PREZZO	NOTE
	SEGNAPREZZO CANCELLABILE SERIE "F" FRUTTA CON ASTA TRIANGOLARE D: 15 X 8 H cm	CPLAFF0807	CAT 2017	€ 25,54	CONF DA 25 PZ+1 PENN *ORDINE MINIMO 6 CONF
	SEGNAPREZZO CANCELLABILE SERIE "F" FRUTTA CON MOLLETTE E ASTE 50 MM CON CLIP D: 15 X 8 H cm	CPLAFF0607	CAT 2017	€ 40,65	CONF DA 25 PZ+1 PENN *ORDINE MINIMO 6 CONF
	SEGNAPREZZO CANCELLABILE SERIE "F" FRUTTA CON MOLLETTE CON CLIP D: 15 X 8 H cm	CPLAFF1007	CAT 2017	€ 35,43	CONF DA 25 PZ+1 PENN *ORDINE MINIMO 6 CONF
	SEGNAPREZZO CANCELLABILE SERIE "F" FORMAGGIO D: 15 X 8 H cm	CPLAFC0103	CAT 2017	€ 13,54	CONF DA 25 PZ *ORDINE MINIMO 6 CONF
	SEGNAPREZZO CANCELLABILE SERIE "F" FORMAGGIO CON AGHI INOX CON CLIP D: 15 X 8 H cm	CPLAFC0303	CAT 2017	€ 38,51	CONF DA 25 PZ+1 PENN *ORDINE MINIMO 6 CONF





# COMUNICAZIONE PREZZO

IMMAGINE	DESCRIZIONE	CODICE E COLORE	PAG CAT	PREZZO	NOTE
	SEGNAPREZZO CANCELLABILE SERIE "F" FORMAGGIO CON AGHI DOPPIA PUNTA STANDARD D: 15 X 8 H cm	CPLAFC0703	CAT 2017	€ 27,59	CONF DA 25 PZ+1 PENN *ORDINE MINIMO 6 CONF
	SEGNAPREZZO CANCELLABILE SERIE "F" FORMAGGIO CON MOLLETTE E ASTE 50 MM CON CLIP D: 15 X 8 H cm	CPLAFC0603	CAT 2017	€ 40,65	CONF DA 25 PZ+1 PENN *ORDINE MINIMO 6 CONF
	SEGNAPREZZO CANCELLABILE SERIE "F" FORMAGGIO D: 15 X 8 H cm CON MOLLETTE CON CLIP	CPLAFC1003	CAT 2017	€ 35,43	CONF DA 25 PZ+1 PENN *ORDINE MINIMO 6 CONF
	SEGNAPREZZO CANCELLABILE SERIE "F" FORMAGGIO CON BASI QUADRIFOGLIO E ASTE 50 MM CON CLIP D: 15 X 8 H cm	CPLAFC6003	CAT 2017	€ 51,58	CONF DA 25 PZ+1 PENN *ORDINE MINIMO 6 CONF
	SEGNAPREZZO CANCELLABILE SERIE "F" SUINO D: 15 X 8 H cm	CPLAFU0124	CAT 2017	€ 13,54	CONF DA 25 PZ *ORDINE MINIMO 6 CONF



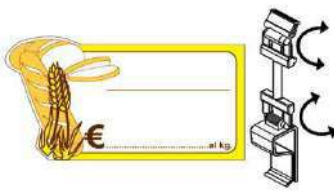

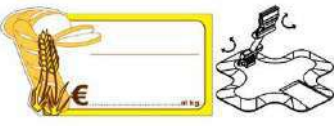
# COMUNICAZIONE PREZZO

IMMAGINE	DESCRIZIONE	CODICE E COLORE	PAG CAT	PREZZO	NOTE
	SEGNAPREZZO CANCELLABILE SERIE "F" SUINO CON AGHI INOX D: 15 X 8 H cm	CPLAFU0324	CAT 2017	€ 38,51	CONF DA 25 PZ+1 PENN *ORDINE MINIMO 6 CONF
	SEGNAPREZZO CANCELLABILE SERIE "F" SUINO CON AGHI DOPPIA PUNTA STANDARD D: 15 X 8 H cm	CPLAFU0724	CAT 2017	€ 27,59	CONF DA 25 PZ+1 PENN *ORDINE MINIMO 6 CONF
	SEGNAPREZZO CANCELLABILE SERIE "F" SUINO CON MOLLETTE E ASTE 50 MM CON CLIP D: 15 X 8 H cm	CPLAFU0624	CAT 2017	€ 40,65	CONF DA 25 PZ+1 PENN *ORDINE MINIMO 6 CONF
	SEGNAPREZZO CANCELLABILE SERIE "F" SUINO CON MOLLETTE CON CLIP D: 15 X 8 H cm	CPLAFU1024	CAT 2017	€ 35,43	CONF DA 25 PZ+1 PENN *ORDINE MINIMO 6 CONF
	SEGNAPREZZO CANCELLABILE SERIE "F" SUINO CON BASI QUADRIFOGLIO E ASTE 50 MM CON CLIP D: 15 X 8 H cm	CPLAFU6024	CAT 2017	€ 51,58	CONF DA 25 PZ+1 PENN *ORDINE MINIMO 6 CONF



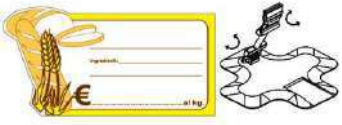

# COMUNICAZIONE PREZZO

IMMAGINE	DESCRIZIONE	CODICE E COLORE	PAG CAT	PREZZO	NOTE
	SEGNAPREZZO CANCELLABILE SERIE "F" PANE D: 15 X 8 H cm	CPLAFB0103	CAT 2017	€ 13,54	CONF DA 25 PZ *ORDINE MINIMO 6 CONF
	SEGNAPREZZO CANCELLABILE SERIE "F" PANE CON MOLLETTE E ASTE 50 MM CON CLIP D: 15 X 8 H cm	CPLAFB0603	CAT 2017	€ 40,65	CONF DA 25 PZ+1 PENN *ORDINE MINIMO 6 CONF
	SEGNAPREZZO CANCELLABILE SERIE "F" PANE CON MOLLETTE CON CLIP D: 15 X 8 H cm	CPLAFB1003	CAT 2017	€ 35,43	CONF DA 25 PZ+1 PENN *ORDINE MINIMO 6 CONF
	SEGNAPREZZO CANCELLABILE SERIE "F" PANE CON BASI QUADRIFOGLIO E ASTE 50 MM CON CLIP D: 15 X 8 H cm	CPLAFB6003	CAT 2017	€ 51,58	CONF DA 25 PZ+1 PENN *ORDINE MINIMO 6 CONF
	SEGNAPREZZO CANCELLABILE SERIE "F" PANE INGREDIENTI D: 15 X 8 H cm	CPLABI0103	CAT 2017	€ 13,54	CONF DA 25 PZ *ORDINE MINIMO 6 CONF



# COMUNICAZIONE PREZZO

IMMAGINE	DESCRIZIONE	CODICE E COLORE	PAG CAT	PREZZO	NOTE
	SEGNAPREZZO CANCELLABILE SERIE "F" PANE INGREDIENTI CON MOLLETTE E ASTE 50 MM CON CLIP D: 15 X 8 H cm	CPLABI0603	CAT 2017	€ 40,65	CONF DA 25 PZ+1 PENN *ORDINE MINIMO 6 CONF
	SEGNAPREZZO CANCELLABILE SERIE "F" PANE INGREDIENTI CON MOLLETTE CON CLIP D: 15 X 8 H cm	CPLABI1003	CAT 2017	€ 35,43	CONF DA 25 PZ+1 PENN *ORDINE MINIMO 6 CONF
	SEGNAPREZZO CANCELLABILE SERIE "F" PANE INGREDIENTI CON BASI QUADRIFOGLIO E ASTE 50 MM CON CLIP D: 15 X 8 H cm	CPLABI6003	CAT 2017	€ 51,58	CONF DA 25 PZ+1 PENN *ORDINE MINIMO 6 CONF
	SEGNAPREZZO CANCELLABILE SERIE "F" TRACCIABILITÀ PESCHERIA D: 15 X 8 H cm	CPLAFP0102	CAT 2017	€ 13,54	CONF DA 25 PZ *ORDINE MINIMO 6 CONF
	SEGNAPREZZO CANCELLABILE SERIE "F" TRACCIABILITÀ PESCHERIA CON AGHI INOX CON CLIP D: 15 X 8 H cm	CPLAFP0302	CAT 2017	€ 38,51	CONF DA 25 PZ+1 PENN *ORDINE MINIMO 6 CONF

# COMUNICAZIONE PREZZO

IMMAGINE	DESCRIZIONE	CODICE E COLORE	PAG CAT	PREZZO	NOTE
	SEGNAPREZZO CANCELLABILE SERIE "F" TRACCIABILITÀ PESCHERIA CON AGHI DOPPIA PUNTA STANDARD D: 15 X 8 H cm	CPLAFP0702	CAT 2017	€ 27,59	CONF DA 25 PZ+1 PENN *ORDINE MINIMO 6 CONF
	SEGNAPREZZO CANCELLABILE SERIE "F" TRACCIABILITÀ PESCHERIA CON ASTA TRIANGOLARE D: 15 X 8 H cm	CPLAFP0802	CAT 2017	€ 28,54	CONF DA 25 PZ+1 PENN *ORDINE MINIMO 6 CONF
	SEGNAPREZZO CANCELLABILE SERIE "F" TRACCIABILITÀ PESCHERIA CON MOLLETTE E ASTE 50 MM CON CLIP D: 15 X 8 H cm	CPLAFP0602	CAT 2017	€ 40,65	CONF DA 25 PZ+1 PENN *ORDINE MINIMO 6 CONF
	SEGNAPREZZO CANCELLABILE SERIE "F" TRACCIABILITÀ PESCHERIA CON MOLLETTE CON CLIP D: 15 X 8 H cm	CPLAFP1002	CAT 2017	€ 35,43	CONF DA 25 PZ+1 PENN *ORDINE MINIMO 6 CONF
	SEGNAPREZZO CANCELLABILE SERIE "F" TRACCIABILITÀ PESCHERIA CON ASTA GHIACCIO D: 15 X 8 H cm	CPLAFP1102	CAT 2017	€ 36,28	CONF DA 25 PZ+1 PENN *ORDINE MINIMO 6 CONF

# COMUNICAZIONE PREZZO

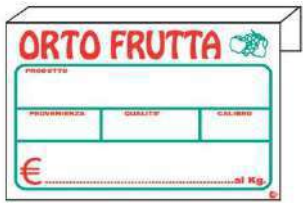
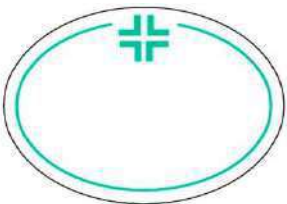
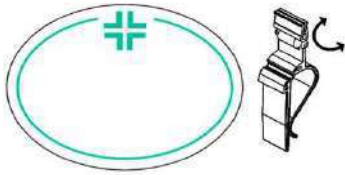
IMMAGINE	DESCRIZIONE	CODICE E COLORE	PAG CAT	PREZZO	NOTE
	SEGNAPREZZO CANCELLABILE SERIE TRACCIABILITÀ ORTOFRUTTA D: 15 X 10 H CM	CPLAFT0101	CAT 2017	€ 17,63	CONF DA 25 PZ
	SEGNAPREZZO CANCELLABILE SERIE TRACCIABILITÀ ORTOFRUTTA CON ASTA TRIANGOLARE D: 15 X 10 H CM	CPLAFT0801	CAT 2017	€ 32,42	CONF DA 25 PZ+1 PENN
	SEGNAPREZZO CANCELLABILE SERIE TRACCIABILITÀ ORTOFRUTTA CON PIEGA POSTERIORE PER L'INSERIMENTO NELLE CASSETTE D: 15 X 10 H CM	CPLAFTC001	CAT 2017	€ 32,35	CONF DA 25 PZ+1 PENN
	SEGNAPREZZO CANCELLABILE SERIE FARMACIA 1 D: 9 x 7 H cm	CPLAF10101	CAT 2017	€ 12,30	CONF DA 25 PZ
	SEGNAPREZZO CANCELLABILE SERIE FARMACIA 1 CON MOLLETTE CON CLIP D: 9 x 7 H cm	CPLAF11001	CAT 2017	€ 34,25	CONF DA 25 PZ+1 PENN

# COMUNICAZIONE PREZZO

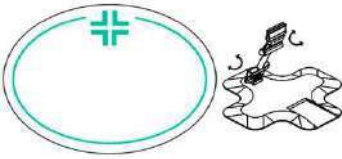
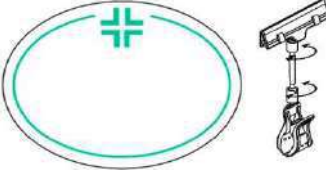
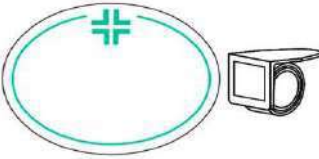
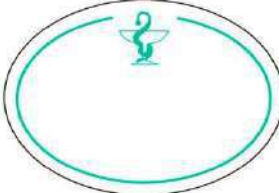
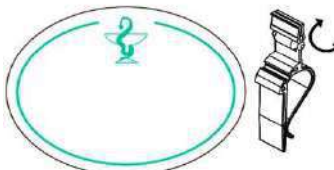

IMMAGINE	DESCRIZIONE	CODICE E COLORE	PAG CAT	PREZZO	NOTE
	SEGNAPREZZO CANCELLABILE SERIE FARMACIA 1 CON BASI QUADRIFOGLIO E ASTE 50 MM CON CLIP D: 9 x 7 H cm	CPLAF16001	CAT 2017	€ 50,40	CONF DA 25 PZ+1 PENN
	SEGNAPREZZO CANCELLABILE SERIE FARMACIA 1 CON PINZA A MOLLA ASTA 50 MM D: 9 x 7 H cm	CPLAF14101	CAT 2017	€ 40,19	CONF DA 25 PZ+1 PENN
	SEGNAPREZZO CANCELLABILE SERIE FARMACIA 1 CON CLIP A CHIOCCIOLA CON ADESIVO D: 9 x 7 H cm	CPLAF15101	CAT 2017	€ 37,10	CONF DA 25 PZ+1 PENN
	SEGNAPREZZO CANCELLABILE SERIE FARMACIA 2 D: 9 x 7 H cm	CPLAF20101	CAT 2017	€ 12,30	CONF DA 25 PZ
	SEGNAPREZZO CANCELLABILE SERIE FARMACIA 2 CON MOLLETTE CON CLIP D: 9 x 7 H cm	CPLAF21001	CAT 2017	€ 34,25	CONF DA 25 PZ+1 PENN



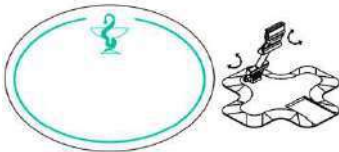
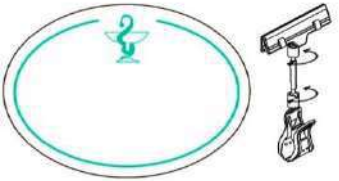
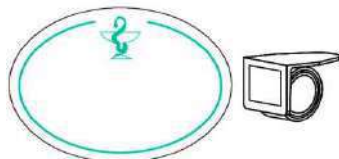
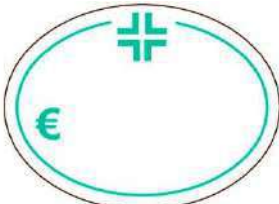
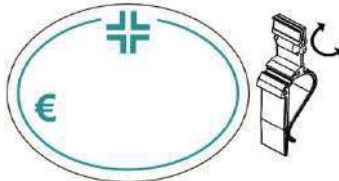

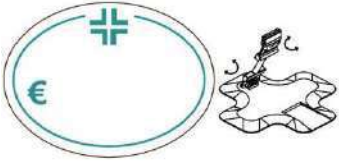
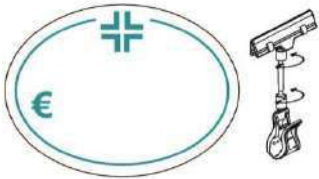
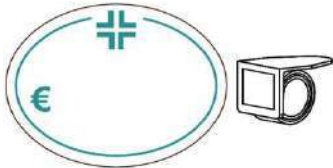

# COMUNICAZIONE PREZZO

IMMAGINE	DESCRIZIONE	CODICE E COLORE	PAG CAT	PREZZO	NOTE
	SEGNAPREZZO CANCELLABILE SERIE FARMACIA 2 CON BASI QUADRIFOGLIO E ASTA 50 MM CON CLIP D: 9 x 7 H cm	CPLAF26001	CAT 2017	€ 50,40	CONF DA 25 PZ+1 PENN
	SEGNAPREZZO CANCELLABILE SERIE FARMACIA 2 CON PINZA A MOLLA ASTA 50 MM D: 9 x 7 H cm	CPLAF24101	CAT 2017	€ 40,19	CONF DA 25 PZ+1 PENN
	SEGNAPREZZO CANCELLABILE SERIE FARMACIA 2 CO CLIP A CHIOCCIOLA CON ADESIVO D: 9 x 7 H cm	CPLAF25101	CAT 2017	€ 37,10	CONF DA 25 PZ+1 PENN
	SEGNAPREZZO CANCELLABILE SERIE FARMACIA 3 D: 9 x 7 H cm	CPLAF30101	CAT 2017	€ 12,30	CONF DA 25 PZ
	SEGNAPREZZO CANCELLABILE SERIE FARMACIA 3 CON MOLLETTE CON CLIP D: 9 x 7 H cm	CPLAF31001	CAT 2017	€ 34,25	CONF DA 25 PZ+1 PENN

# COMUNICAZIONE PREZZO

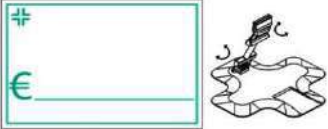
IMMAGINE	DESCRIZIONE	CODICE E COLORE	PAG CAT	PREZZO	NOTE
	SEGNAPREZZO CANCELLABILE SERIE FARMACIA 3 CON BASI QUADRIFOGLIO E ASTA 50 MM CON CLIP D: 9 x 7 H cm	CPLAF36001	CAT 2017	€ 50,40	CONF DA 25 PZ+1 PENN
	SEGNAPREZZO CANCELLABILE SERIE FARMACIA 3 CON PINZA A MOLLA ASTA 50 MM D: 9 x 7 H cm	CPLAF34101	CAT 2017	€ 40,19	CONF DA 25 PZ+1 PENN
	SEGNAPREZZO CANCELLABILE SERIE FARMACIA 3 CON CLIP A CHIOCCIOLA CON ADESIVO D: 9 x 7 H cm	CPLAF35101	CAT 2017	€ 37,10	CONF DA 25 PZ+1 PENN
	SEGNAPREZZO CANCELLABILE SERIE FARMACIA 4 D: 9 x 7 H cm	CPLAF40101	CAT 2017	€ 11,30	CONF DA 25 PZ
	SEGNAPREZZO CANCELLABILE SERIE FARMACIA 4 CON MOLLETTE CON CLIP D: 9 x 7 H cm	CPLAF41001	CAT 2017	€ 33,30	CONF DA 25 PZ+1 PENN

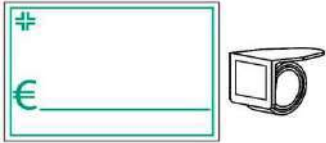

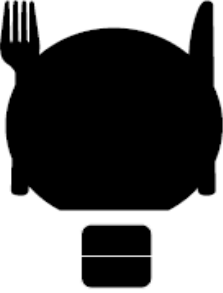
# COMUNICAZIONE PREZZO

IMMAGINE	DESCRIZIONE	CODICE E COLORE	PAG CAT	PREZZO	NOTE
	<p>SEGNAPREZZO CANCELLABILE SERIE FARMACIA 4 CON BASI A QUADRIFOGLIO E ASTA 50 MM CON CLIP D: 9 x 7 H cm</p>	CPLAF46001	CAT 2017	€ 49,45	CONF DA 25 PZ+1 PENN
	<p>SEGNAPREZZO CANCELLABILE SERIE FARMACIA 4 CON PINZA A MOLLA ASTA 50 MM D: 9 x 7 H cm</p>	CPLAF44101	CAT 2017	€ 39,24	CONF DA 25 PZ+1 PENN
	<p>SEGNAPREZZO CANCELLABILE SERIE FARMACIA 4 CON CLIP A CHIOCCIOLA CON ADESIVO D: 9 x 7 H cm</p>	CPLAF45101	CAT 2017	€ 36,15	CONF DA 25 PZ+1 PENN
	<p>LAVAGNA DA TAVOLO NEUTRA D: 15 x 21 H cm</p>	CPLTNFX00205	89	€ 8,40	
	<p>LAVAGNA DA TAVOLO NEUTRA D: 24 x 25 H cm</p>	CPLTNFX00805	89	€ 15,40	

# COMUNICAZIONE PREZZO

IMMAGINE	DESCRIZIONE	CODICE E COLORE	PAG CAT	PREZZO	NOTE
	LAVAGNA DA TAVOLO NEUTRA D: 21 x 33 H cm	CPLTNFX01105	89	€ 15,40	
	LAVAGNA DA TAVOLO NEUTRA D: 15 x 21 H cm	CPLTNFX01205	89	€ 9,80	
	LAVAGNA DA TAVOLO NEUTRA D: 20 X 30 H cm	CPLTNFX01305	89	€ 15,40	
	LAVAGNA DA TAVOLO NEUTRA D: 40 x 36 H cm	CPLTNFX01405	89	€ 22,40	
	LAVAGNA DA TAVOLO NEUTRA D: 30 x 15 H cm	CPLTNFX01505	89	€ 9,80	

# COMUNICAZIONE PREZZO

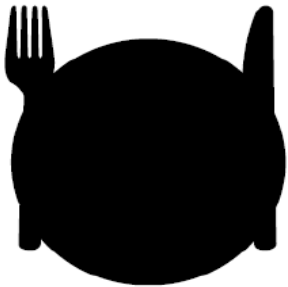
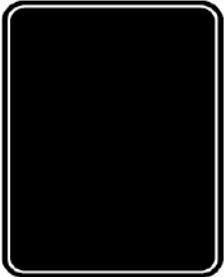
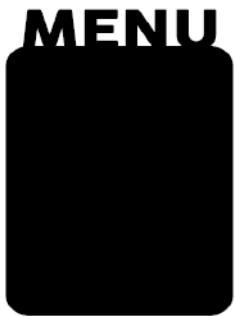
IMMAGINE	DESCRIZIONE	CODICE E COLORE	PAG CAT	PREZZO	NOTE
	LAVAGNA DA TAVOLO NEUTRA D: 23 x 30 H cm	CPLTNFX01605	89	€ 15,40	
	LAVAGNA DA TAVOLO NEUTRA D: 30 x 50 H cm	CPLTNFX01705	89	€ 25,20	
	LAVAGNA DA PARETE D: 45 x 50 H cm	CPLPNFX00005	90	€ 25,20	
	LAVAGNA DA PARETE D: 50 x 70 H cm	CPLPNFX00105	90	€ 25,20	
	LAVAGNA DA PARETE D: 30 x 45 H cm	CPLPNFX00305	90	€ 25,20	

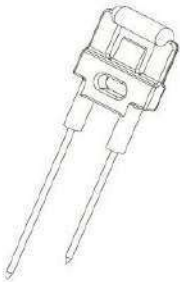
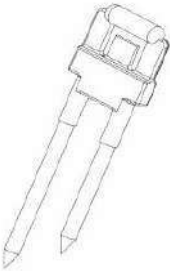
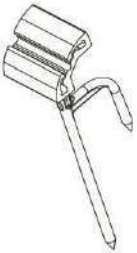
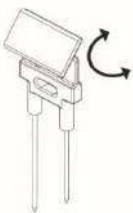

# COMUNICAZIONE PREZZO

IMMAGINE	DESCRIZIONE	CODICE E COLORE	PAG CAT	PREZZO	NOTE
	LAVAGNA DA PARETE D: 30 x 70 H cm	CPLPNFX00205	90	€ 25,20	
	AGO INOX IN POM E ACCIAIO AISI304	CPAAAG0401 CPAAAG0405	92	€ 18,75	CONF DA 25 PZ
	AGO DOPPIA PUNTA IN POM	CPAAAG0501 CPAAAG0505	92	€ 15,50	CONF DA 25 PZ
	AGO DOPPIA PUNTA STANDARD IN POM	CPAAAG0101 CPAAAG0105	92	€ 15,50	CONF DA 25 PZ
	AGO INOX CON ADATTATORE PIANO IN POM E ACCIAIO AISI304	CPAAAIAP01 CPAAAIAP05	92	€ 24,25	CONF DA 25 PZ

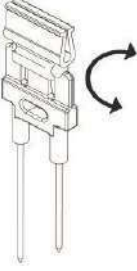
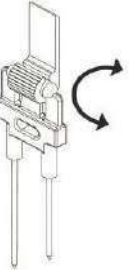
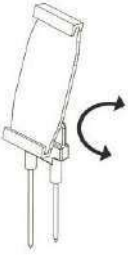
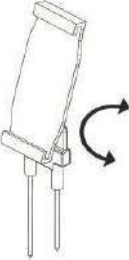
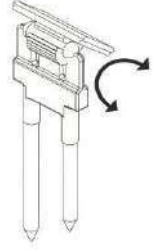
# COMUNICAZIONE PREZZO

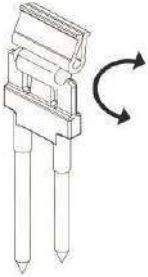
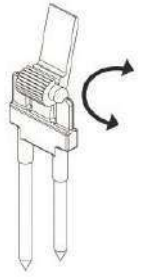
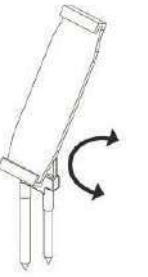
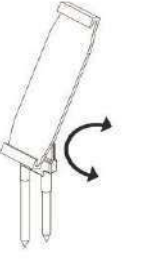

IMMAGINE	DESCRIZIONE	CODICE E COLORE	PAG CAT	PREZZO	NOTE
	AGO INOX CON CLIP A PRESSIONE IN POM E ACCIAIO AISI304	CPAAAICL01 CPAAAICL05	92	€ 27,00	CONF DA 25 PZ
	AGO INOX CON ADATTATORE VERTICALE IN POM E ACCIAIO AISI304	CPAAAIAV01 CPAAAIAV05	92	€ 24,38	CONF DA 25 PZ
	AGO INOX CON INSERTO A "C" A7 IN POM E ACCIAIO AISI304	CPAAAIC701 CPAAAIC705	92	€ 28,25	CONF DA 25 PZ
	AGO INOX XON INSERTO A "C" A6 IN POM E ACCIAIO AISI304	CPAAAIC601 CPAAAIC605	93	€ 28,74	CONF DA 25 PZ
	AGO DOPPIA PUNTA CON ADATTATORE PIANO IN POM	CPAAAPAP01 CPAAAPAP05	93	€ 21,00	CONF DA 25 PZ

# COMUNICAZIONE PREZZO





IMMAGINE	DESCRIZIONE	CODICE E COLORE	PAG CAT	PREZZO	NOTE
	AGO DOPPIA PUNTA CON CLIP A PRESSIONE IN POM	CPAAAPCL01 CPAAAPCL05	93	€ 23,75	CONF DA 25 PZ
	AGO DOPPIA PUNT CON ADATTATORE VERTICALE IN POM	CPAAAPAV01 CPAAAPAV05	93	€ 21,13	CONF DA 25 PZ
	AGO DOPPIA PUNTA CON INSERTO A "C" A7 IN POM	CPAAAPC701 CPAAAPC705	93	€ 25,00	CONF DA 25 PZ
	AGO DOPPIA PUNTA CON INSERTO A "C" A6 IN POM	CPAAAPC601 CPAAAPC605	93	€ 25,49	CONF DA 25 PZ
	ASTA TRIANGOLARE PER SEGNAPREZZI IN POM	CPAAAT0101 CPAAAT0105	94	€ 16,50	CONF DA 25 PZ

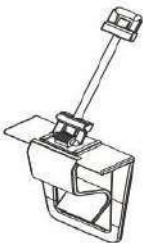

# COMUNICAZIONE PREZZO

IMMAGINE	DESCRIZIONE	CODICE E COLORE	PAG CAT	PREZZO	NOTE
	ASTA PER GHIACCIO TRASPARENTE IN POM 15 cm	CPAAAT0208	94	€ 24,65	CONF DA 25 PZ
	ASTA PER GHIACCIO TRASPARENTE CON INSERTO A "C" A7 IN POM 15 cm	CPAAAGC701 CPAAAGC705	94	€ 34,15	CONF DA 25 PZ
	ASTA PER GHIACCIO TRASPARENTE CON INSERTO A "C" A6 IN POM 15 cm	CPAAAGC601 CPAAAGC605	94	€ 31,64	CONF DA 25 PZ
	MOLLETTONE PER CASSETTE CON ASTA IN POM L: 5 cm	CPAAAM00505	95	€ 36,00	CONF DA 25 PZ
	MOLLETTONE PER CASSETTE CON ASTA IN POM L: 10 cm	CPAAAM01005	95	€ 36,25	CONF DA 25 PZ
	MOLLETTONE PER CASSETTE CON ASTA IN POM L: 15 cm	CPAAAM01505	95	€ 36,50	CONF DA 25 PZ

# COMUNICAZIONE PREZZO

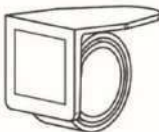
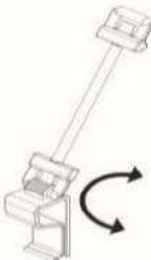
IMMAGINE	DESCRIZIONE	CODICE E COLORE	PAG CAT	PREZZO	NOTE
	MOLLETTA IN POM	CPAATN0101 CPAATN0105	95	€ 15,50	CONF DA 25 PZ
	MOLLETTA PER SNODI IN POM	CPAATJ0801 CPAATJ0805	95	€ 15,50	CONF DA 25 PZ
	MOLLETTA CON CLIP IN POM	CPAATNCL01 CPAATNCL05	95	€ 23,75	CONF DA 25 PZ
	ASTA DOPPIO SNODO IN POM L: 3 cm	CPAAAT0301 CPAAAT0305 CPAAAT0308	95	€ 5,50	CONF DA 25 PZ
	ASTA PER SNODI IN POM L: 5 cm	CPAAAT0501 CPAAAT0505	95	€ 5,50	CONF DA 25 PZ
	ASTA PER SNODI IN POM L: 10 cm	CPAAAT1001 CPAAAT1005	95	€ 5,75	CONF DA 25 PZ
	ASTA PER SNODI IN POM L: 15 cm	CPAAAT1501 CPAAAT1505	95	€ 6,00	CONF DA 25 PZ
	CLIP A CHIOCCIOLA PER RIPIANI CON ADATTATORE VERTICALE IN PC+POM	CPAACLC101	95	€ 26,75	CONF DA 25 PZ
	MOLLETTA CON ASTA IN POM L: 3 cm	CPAASA0301 CPAASA0305	96	€ 21,00	CONF DA 25 PZ
	MOLLETTA CON ASTA IN POM L: 5 cm	CPAASA0501 CPAASA0505	96	€ 21,00	CONF DA 25 PZ
	MOLLETTA CON ASTA IN POM L: 10 cm	CPAASA1001 CPAASA1005	96	€ 21,25	CONF DA 25 PZ
	MOLLETTA CON ASTA IN POM L: 15 cm	CPAASA1501 CPAASA1505	96	€ 21,50	CONF DA 25 PZ

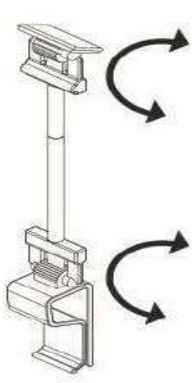
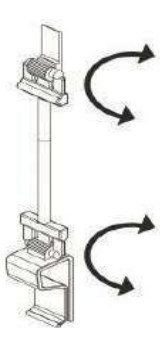

# COMUNICAZIONE PREZZO

IMMAGINE	DESCRIZIONE	CODICE E COLORE	PAG CAT	PREZZO	NOTE
	MOLLETTA CON SNODO ASTA CON ADATTATORE PIANO IN POM L: 3 cm	CPAASE0301 CPAASE0305	96	€ 26,50	CONF DA 25 PZ
	MOLLETTA CON SNODO ASTA CON ADATTATORE PIANO IN POM L: 5 cm	CPAASE0501 CPAASE0505	96	€ 26,50	CONF DA 25 PZ
	MOLLETTA CON SNODO ASTA CON ADATTATORE PIANO IN POM L: 10 cm	CPAASE1001 CPAASE1005	96	€ 26,75	CONF DA 25 PZ
	MOLLETTA CON SNODO ASTA CON ADATTATORE PIANO IN POM L: 15 cm	CPAASE1501 CPAASE1505	96	€ 27,00	CONF DA 25 PZ
	MOLLETTA CON ASTA CON ADATTATORE VERTICALE IN POM L: 3 cm	CPAAST0301 CPAAST0305	96	€ 26,63	CONF DA 25 PZ
	MOLLETTA CON ASTA CON ADATTATORE VERTICALE IN POM L: 5 cm	CPAAST0501 CPAAST0505	96	€ 26,63	CONF DA 25 PZ
	MOLLETTA CON ASTA CON ADATTATORE VERTICALE IN POM L: 10 cm	CPAAST1001 CPAAST1005	96	€ 26,88	CONF DA 25 PZ
	MOLLETTA CON ASTA CON ADATTATORE VERTICALE IN POM L: 15 cm	CPAAST1501 CPAAST1505	96	€ 27,13	CONF DA 25 PZ

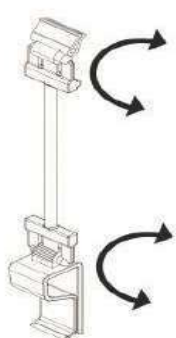
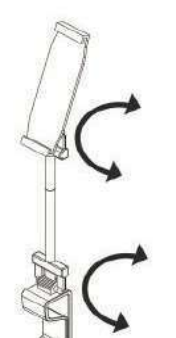
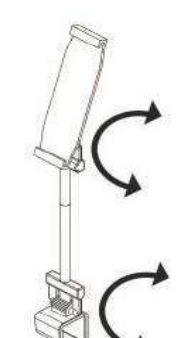

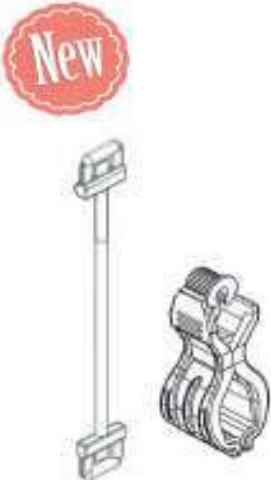

# COMUNICAZIONE PREZZO

IMMAGINE	DESCRIZIONE	CODICE E COLORE	PAG CAT	PREZZO	NOTE
	MOLLETTA CON SNODO ASTA CON CLIP A PRESSIONE IN POM L: 3 cm	CPAASC0301 CPAASC0305	96	€ 29,25	CONF DA 25 PZ
	MOLLETTA CON SNODO ASTA CON CLIP A PRESSIONE IN POM L: 5 cm	CPAASC0501 CPAASC0505	96	€ 29,25	CONF DA 25 PZ
	MOLLETTA CON SNODO ASTA CON CLIP A PRESSIONE IN POM L: 10 cm	CPAASC1001 CPAASC1005	96	€ 29,50	CONF DA 25 PZ
	MOLLETTA CON SNODO ASTA CON CLIP A PRESSIONE IN POM L: 15 cm	CPAASC1501 CPAASC1505	96	€ 29,75	CONF DA 25 PZ
	MOLLETTA CON ASTA E INSERTO A "C" A7 IN POM L: 3 cm	CPAAS70301 CPAAS70305	96	€ 30,50	CONF DA 25 PZ
	MOLLETTA CON ASTA E INSERTO A "C" A7 IN POM L: 5 cm	CPAAS70501 CPAAS70505	96	€ 30,50	CONF DA 25 PZ
	MOLLETTA CON ASTA E INSERTO A "C" A7 IN POM L: 10 cm	CPAAS71001 CPAAS71005	96	€ 30,75	CONF DA 25 PZ
	MOLLETTA CON ASTA E INSERTO A "C" A7 IN POM L: 15 cm	CPAAS71501 CPAAS71505	96	€ 31,00	CONF DA 25 PZ
	MOLLETTA CON ASTA E INSERTO A "C" A6 IN POM L: 3 cm	CPAAS60301 CPAAS60305	96	€ 30,99	CONF DA 25 PZ
	MOLLETTA CON ASTA E INSERTO A "C" A6 IN POM L: 5 cm	CPAAS60501 CPAAS60505	96	€ 30,99	CONF DA 25 PZ
	MOLLETTA CON ASTA E INSERTO A "C" A6 IN POM L: 10 cm	CPAAS61001 CPAAS61005	96	€ 31,24	CONF DA 25 PZ
	MOLLETTA CON ASTA E INSERTO A "C" A6 IN POM L: 15 cm	CPAAS61501 CPAAS61505	96	€ 31,49	CONF DA 25 PZ



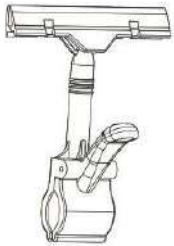

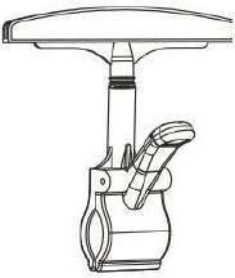
# COMUNICAZIONE PREZZO

IMMAGINE	DESCRIZIONE	CODICE E COLORE	PAG CAT	PREZZO	NOTE
	PINZA SNODABILE CON ADATTATORE VERTICALE IN PC	CPAAPSAV05	96	€ 36,63	CONF DA 25 PZ
	PINZA CON ASTA IN ABS L: 5 cm	CPAAPZ0105	96	€ 40,00	CONF DA 25 PZ
	PINZA MAXI IN POM	CPAAZZ0101 CPAAZZ0105 CPAAZZ0108	97	€ 40,00	CONF DA 25 PZ
	PINZA MAXI IN POM CON ASTA	CPAASP0301 CPAASP0305 CPAASP0308	97	€ 43,23	CONF DA 25 PZ
	PINZA MAXI IN POM CON ASTA	CPAASP0501 CPAASP0505 CPAASP0508	97	€ 43,23	CONF DA 25 PZ
	PINZA MAXI IN POM CON ASTA	CPAASP1001 CPAASP1005 CPAASP1008	97	€ 43,46	CONF DA 25 PZ
	PINZA MAXI IN POM CON ASTA	CPAASP1501 CPAASP1505 CPAASP1508	97	€ 43,70	CONF DA 25 PZ



# COMUNICAZIONE PREZZO

IMMAGINE	DESCRIZIONE	CODICE E COLORE	PAG CAT	PREZZO	NOTE
	PINZA CON ASTA IN ABS L: 15 cm	CPAAPZ0205	97	€ 50,00	CONF DA 25 PZ
	PINZA CON ASTA E ATTACCO A MOLLA IN ABS L: 5 cm	CPAAPZM105	97	€ 45,00	CONF DA 25 PZ
	PINZA CON ASTA E ATTACCO A MOLLA IN ABS L: 15 cm	CPAAPZM205	97	€ 55,00	CONF DA 25 PZ
	PINZA CON ASTA PER LAVAGNE FOREX DA 3 mm IN ABS L: 5 cm	CPAAPZF105	97	€ 45,00	CONF DA 25 PZ
	PINZA CON ASTA PER LAVAGNE FOREX DA 3 mm IN ABS L: 15 cm	CPAAPZF205	97	€ 55,00	CONF DA 25 PZ

# COMUNICAZIONE PREZZO

IMMAGINE	DESCRIZIONE	CODICE E COLORE	PAG CAT	PREZZO	NOTE
	PINZA CON ADATTATORE PIANO IN ABS L: 5 cm	CPAAPZP105	97	€ 45,50	CONF DA 25 PZ
	PINZA CON ADATATORE PIANO IN ABS L: 15 cm	CPAAPZP205	98	€ 55,50	CONF DA 25 PZ
	PINZA CON ASTA E ADATTATORE VERTICALE IN ABS L: 5 cm	CPAAPZV105	98	€ 45,63	CONF DA 25 PZ
	PINZA CON ASTA E ADATTATORE VERTICALE IN ABS L: 15 cm	CPAAPZV205	98	€ 55,63	CONF DA 25 PZ
	PINZA CON ASTA E CLIP A PRESSIONE IN ABS L: 5 cm	CPAAPZC105	98	€ 48,25	CONF DA 25 PZ

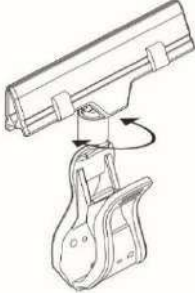
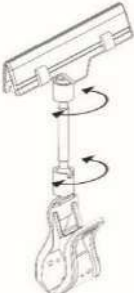
# COMUNICAZIONE PREZZO

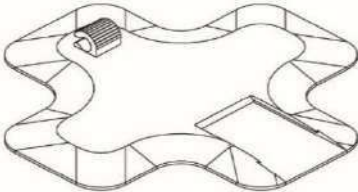
IMMAGINE	DESCRIZIONE	CODICE E COLORE	PAG CAT	PREZZO	NOTE
	PINZA CON ASTA E CLIP A PRESSIONE IN ABS L: 15 cm	CPAAPZC205	98	€ 58,25	CONF DA 25 PZ
	B1 SNODO CON PORTA MESSAGGI E PINZA A MOLLA SENZA ASTA IN PC+FE	CPAASN0105 CPAASN0108	98	€ 28,00	CONF DA 25 PZ
	B2 SNODO CON PORTA MESSAGGI E PINZA A MOLLA CON ASTA IN PC+FE L: 5 cm	CPAASN0508	98	€ 30,00	CONF DA 25 PZ
	B3 SNODO CON PORTA MESSAGGI E PINZA A MOLLA IN PC+FE L: 10 cm	CPAASN1005 CPAASN1008	98	€ 32,00	CONF DA 25 PZ
	BASI A QUADRIFOGLIO IN POM D: 11 x 10 cm	CPAAQT0101 CPAAQT0105 CPAAQT0108	99	€ 27,00	CONF DA 25 PZ



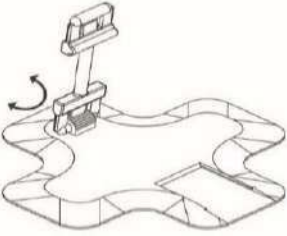
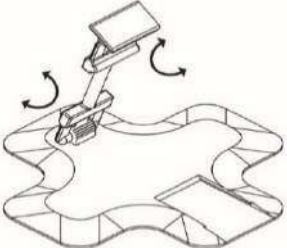
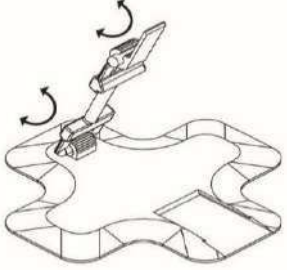

# COMUNICAZIONE PREZZO

IMMAGINE	DESCRIZIONE	CODICE E COLORE	PAG CAT	PREZZO	NOTE
	PIANTANA CON ASTA IN POM L: 3 cm	CPAAQW0301 CPAAQW0305 CPPAAQW0308	99	€ 32,50	CONF DA 25 PZ
	PIANTANA CON ASTA IN POM L: 5 cm	CPAAQW0501 CPAAQW0505 CPPAAQW0508	99	€ 32,50	CONF DA 25 PZ
	PIANTANA CON ASTA IN POM L: 10 cm	CPAAQW1001 CPAAQW1005 CPAAQW1008	99	€ 32,75	CONF DA 25 PZ
	PIANTANA CON ASTA IN POM L: 15 cm	CPAAQW1501 CPAAQW1505 CPAAQW1508	99	€ 33,00	CONF DA 25 PZ
	PIANTANA CON ASTA E ADATTATORE PIANO IN POM L: 3 cm	CPAAQE0301 CPAAQE0305 CPAAQE0308	99	€ 38,00	CONF DA 25 PZ
	PIANTANA CON ASTA E ADATTATORE PIANO IN POM L: 5 cm	CPAAQE0501 CPAAQE0505 CPAAQE0508	99	€ 38,00	CONF DA 25 PZ
	PIANTANA CON ASTA E ADATTATORE PIANO IN POM L: 10 cm	CPAAQE1001 CPAAQE1005 CPAAQE1008	99	€ 38,25	CONF DA 25 PZ
	PIANTANA CON ASTA E ADATTATORE PIANO IN POM L: 15 cm	CPAAQE1501 CPAAQE1505 CPAAQE1508	99	€ 38,50	CONF DA 25 PZ
	PIANTANA CON ASTA E ADATTATORE VERTICALE IN POM L: 3 cm	CPAAQT0301 CPAAQT0305 CPAAQT0308	99	€ 38,13	CONF DA 25 PZ
	PIANTANA CON ASTA E ADATTATORE VERTICALE IN POM L: 5 cm	CPAAQT0501 CPAAQT0505 CPAAQT0508	99	€ 38,13	CONF DA 25 PZ
	PIANTANA CON ASTA E ADATTATORE VERTICALE IN POM L: 10 cm	CPAAQT1001 CPAAQT1005 CPAAQT1008	99	€ 38,38	CONF DA 25 PZ
	PIANTANA CON ASTA E ADATTATORE VERTICALE IN POM L: 15 cm	CPAAQT1501 CPAAQT1505 CPAAQT1508	99	€ 38,63	CONF DA 25 PZ

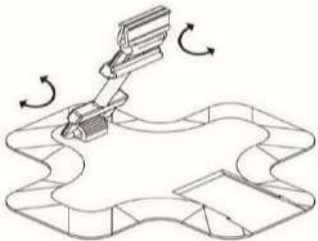
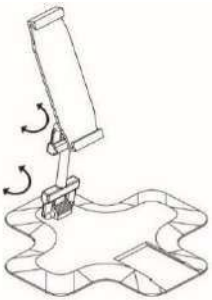
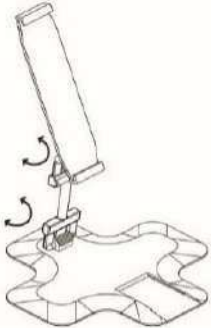
# COMUNICAZIONE PREZZO

IMMAGINE	DESCRIZIONE	CODICE E COLORE	PAG CAT	PREZZO	NOTE
	PIANTANA CON ASTA E CLIP IN POM L: 3 cm	CPAAQC0301 CPAAQC0305 CPAAQC0308	99	€ 40,75	CONF DA 25 PZ
	PIANTANA CON ASTA E CLIP IN POM L: 5 cm	CPAAQC0501 CPAAQC0505 CPAAQC0508	99	€ 40,75	CONF DA 25 PZ
	PIANTANA CON ASTA E CLIP IN POM L: 10 cm	CPAAQC1001 CPAAQC1005 CPAAQC1008	99	€ 41,00	CONF DA 25 PZ
	PIANTANA CON ASTA E CLIP IN POM L: 15 cm	CPAAQC1501 CPAAQC1505 CPAAQC1508	99	€ 41,25	CONF DA 25 PZ
	PIANTANA CON ASTA E ADATTATORE A "C" A7 IN POM L: 3 cm	CPAAQ70301 CPAAQ70305 CPAAQ70308	100	€ 42,00	CONF DA 25 PZ
	PIANTANA CON ASTA E ADATTATORE A "C" A7 IN POM L: 5 cm	CPAAQ70501 CPAAQ70505 CPAAQ70508	100	€ 42,00	CONF DA 25 PZ
	PIANTANA CON ASTA E ADATTATORE A "C" A7 IN POM L: 10 cm	CPAAQ71001 CPAAQ71005 CPAAQ71008	100	€ 42,25	CONF DA 25 PZ
	PIANTANA CON ASTA E ADATTATORE A "C" A7 IN POM L: 15 cm	CPAAQ71501 CPAAQ71505 CPAAQ71508	100	€ 42,50	CONF DA 25 PZ
	PIANTANA CON ASTA E ADATTATORE A "C" A6 IN POM L: 3 cm	CPAAQ60301 CPAAQ60305 CPAAQ60308	100	€ 42,49	CONF DA 25 PZ
	PIANTANA CON ASTA E ADATTATORE A "C" A6 IN POM L: 5 cm	CPAAQ60501 CPAAQ60505 CPAAQ60508	100	€ 42,49	CONF DA 25 PZ
	PIANTANA CON ASTA E ADATTATORE A "C" A6 IN POM L: 10 cm	CPAAQ61001 CPAAQ61005 CPAAQ61008	100	€ 42,74	CONF DA 25 PZ
	PIANTANA CON ASTA E ADATTATORE A "C" A6 IN POM L: 15 cm	CPAAQ61501 CPAAQ61505 CPAAQ61508	100	€ 42,99	CONF DA 25 PZ

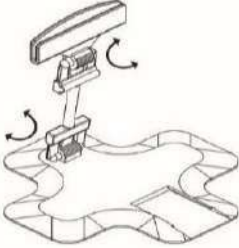
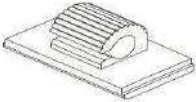

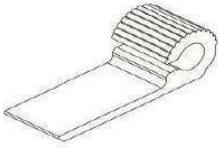
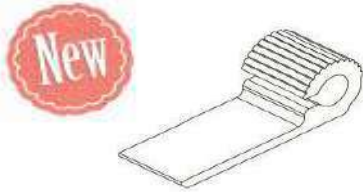
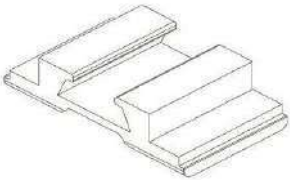
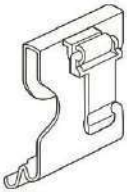
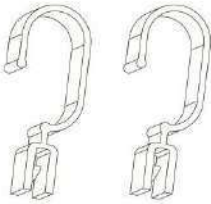
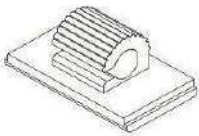

# COMUNICAZIONE PREZZO

IMMAGINE	DESCRIZIONE	CODICE E COLORE	PAG CAT	PREZZO	NOTE
	PIANTANA CON ASTA E CLIP CON PORTA MESSAGGI OVALE IN POM L: 3 cm	CPAAQM0501 CPAAQM0505 CPAAQM0508	100	€ 55,00	CONF DA 25 PZ
	PIANTANA CON ASTA E CLIP CON PORTA MESSAGGI OVALE IN POM L: 5 cm	CPAAQM0301 CPAAQM0305 CPAAQM0308	100	€ 55,00	CONF DA 25 PZ
	PIANTANA CON ASTA E CLIP CON PORTA MESSAGGI OVALE IN POM L: 10 cm	CPAAQM1001 CPAAQM1005 CPAAQM1008	100	€ 55,25	CONF DA 25 PZ
	PIANTANA CON ASTA E CLIP CON PORTA MESSAGGI OVALE IN POM L: 15 cm	CPAAQM1501 CPAAQM1505 CPAAQM1508	100	€ 55,50	CONF DA 25 PZ
	ADATTATORE PIANO IN POM	CPAAIG0101 CPAAIG0105	100	€ 5,50	CONF DA 25 PZ
	PIANTANA CON BASE E ASTA INOX + ADATTATORE IN STS L: 12 cm	CP27PIA12	100	€ 85,75	CONF DA 25 PZ
	PIANTANA CON BASE E ASTA INOX PIÙ ADATTATORE IN STS L: 19 cm	CP28PIA12	100	€ 91,58	CONF DA 25 PZ
	ADATTATORE PER PIANTANA INOX IN POM	CP29ATT01 CP29ATT05	100	€ 5,10	CONF DA 25 PZ

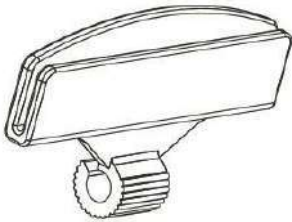

# COMUNICAZIONE PREZZO

IMMAGINE	DESCRIZIONE	CODICE E COLORE	PAG CAT	PREZZO	NOTE
	ADATTATORE VERTICALE IN POM	CPAAMU6401 CPAAMU6405	101	€ 5,63	CONF DA 25 PZ
	ADATTATORE VERTICALE IN POM	CPAAXU6401 CPAAXU6405	101	€ 6,96	CONF DA 25 PZ
	SLITTA PER ADATTATORE VERTICALE IN POM	CPAASL6401	101	€ 5,63	CONF DA 25 PZ
	ADATTATORE BASCULANTE IN POM	CPAABS0101	101	€ 17,05	CONF DA 25 PZ
	COPPIA DI GANCI PER DIAMETRO MAX 2 cm IN PC D: 2,6 x 6,4 cm	CPAADHOT08	101	€ 14,40	CONF DA 20 PZ
	ADATTATORE PIANO IN POM	CPAAIG0101 CPAAIG0105	101	€ 5,50	CONF DA 25 PZ

# COMUNICAZIONE PREZZO

IMMAGINE	DESCRIZIONE	CODICE E COLORE	PAG CAT	PREZZO	NOTE
	CLIP CON PORTA MESSAGGI OVALE PER SPESSORE MAX 0,6 mm IN PC	CPAAACLO201 CPAAACLO205	101	€ 22,50	CONF DA 25 PZ
	ADATTATORE A "C" PER LAVAGNE FORMATO A7 IN POM	CPAAAIN0701 CPAAAIN0705	101	€ 9,50	CONF DA 25 PZ
	ADATTATORE A "C" PER LAVAGNE FORMATO A6 IN POM	CPAAAIN0601 CPAAAIN0605	101	€ 9,99	CONF DA 25 PZ
	CLIP A PRESSIONE IN POM	CPAAACLO101 CPAAACLO105	101	€ 8,25	CONF DA 25 PZ
	SUPPORTO PER SUPPLEMENTI VISIVI IN POM	CPAASV0101 CPAASV0105	101	€ 9,90	CONF DA 25 PZ

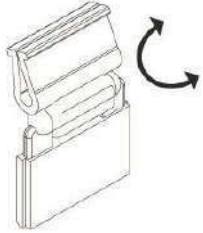
# COMUNICAZIONE PREZZO

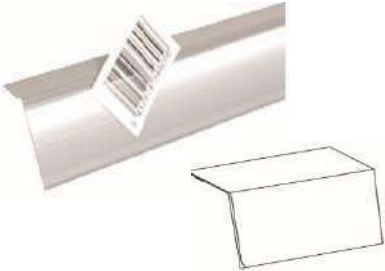
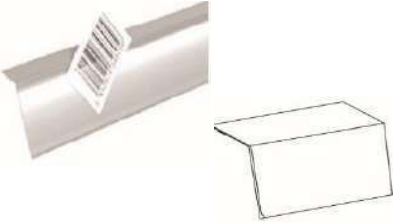
IMMAGINE	DESCRIZIONE	CODICE E COLORE	PAG CAT	PREZZO	NOTE
	CURSORE CON SUPPORTO SUPPLEMENTO VISIVO CON CLIP A PRESSIONE IN POM	CPAASVCL01 CPAASVCL05	101	€ 18,15	CONF DA 25 PZ
	PROFILO PORTA PREZZO PIATTO ADESIVO D: 98,8 x 3 H cm	CPPRADH31001 CPPRADH31008	102	€ 2,75	
	PROFILO PORTA PREZZO PIATTO ADESIVO D: 131,8 x 3 H cm	CPPRADH31301 CPPRADH31308	102	€ 3,63	
	PROFILO PORTA PREZZO PIATTO ADESIVO D: 98,8 x 4 H cm	CPPRADH41001	102	€ 3,11	
		CPPRADH41008	102	€ 3,11	
	PROFILO PORTA PREZZO PIATTO ADESIVO D: 131,8 x 4 H cm	CPPRADH41301	102	€ 4,11	
CPPRADH41308		102	€ 4,11		
	PROFILO PORTA PREZZO ADESIVO INCLINATO 105° D: 98,8 x 4 H cm	CPPR102S1001 CPPR102S1008	102	€ 4,78	
	PROFILO PORTA PREZZO ADESIVO INCLINATO 105° D: 131,8 x 4 H cm	CPPR102S1301 CPPR102S1308	102	€ 6,31	
	PROFILO PORTA PREZZO 90° D: 98,8 x 4 H cm	CPPR111S1001 CPPR111S1008	102	€ 4,78	
	PROFILO PORTA PREZZO 90° D: 131,8 x 4 H cm	CPPR111S11301 CPPR111S11308	102	€ 6,31	

# COMUNICAZIONE PREZZO



IMMAGINE	DESCRIZIONE	CODICE E COLORE	PAG CAT	PREZZO	NOTE
	PROFILO PORTA PREZZO TEGOMETALL 50 D: 98,8 x 4 H cm	CPPRTGM41001 CPPRTGM41008	102	€ 2,96	
	PROFILO PORTA PREZZO TEGOMETALL 50 D: 131,8 x 4 H cm	CPPRTGM41301 CPPRTGM41308	102	€ 3,90	
	PROFILO PORTA PREZZO P25 CEFLA BASCULANTE D: 98,8 x 4 H cm	CPPRCEB41001 CPPRCEB41008	103	€ 3,94	
	PROFILO PORTA PREZZO P25 CEFLA BASCULANTE D: 131,8 x 4 H cm	CPPRCEB41301 CPPRCEB41308	103	€ 5,21	
	PROFILO PORTA PREZZO CEFLA SYSTEM 10 D: 98,8 x 3 H cm	CPPRSY102001 CPPRSY102008	103	€ 3,64	
	PROFILO PORTA PREZZO CEFLA SYSTEM 10 D: 131,8 x 3 H cm	CPPRSY102301 CPPRSY102308	103	€ 4,80	
	PROFILO PORTA PREZZO CEFLA SYSTEM 10 D: 98,8 x 4 H cm	CPPRSY101001 CPPRSY101008	103	€ 3,63	
	PROFILO PORTA PREZZO CEFLA SYSTEM 10 D: 131,8 x 4 H cm	CPPRSY101301 CPPRSY101308	103	€ 4,79	
	PROFILO PORTA PREZZO P25 LA FORTEZZA D: 98,8 x 4 H cm	CPPRPET41001 CPPRPET41008	103	€ 4,64	
	PROFILO PORTA PREZZO P25 LA FORTEZZA D: 131,8 x 4 H cm	CPPRPET41301 CPPRPET41308	103	€ 6,12	

# COMUNICAZIONE PREZZO

IMMAGINE	DESCRIZIONE	CODICE E COLORE	PAG CAT	PREZZO	NOTE
	PROFILO PORTA PREZZO PER CESTI D: 98,8 x 4 H cm	CPPR03210101 CPPR03210108	103	€ 4,84	
	PROFILO PER RIPIANI IN VETRO SPESSORE 6-10 mm NON BASCULANTE D: 98,8 x 2 H cm	CPPRTA200501 CPPRTA200508	103	€ 2,32	
	PROFILO PER RIPIANI IN VETRO SPESSORE 6-10 mm NON BASCULANTE D: 131,8 x 2 H cm	CPPRTA200901 CPPRTA200908	103	€ 3,06	
	PROFILO PER RIPIANI IN VETRO SPESSORE 6-10 mm NON BASCULANTE D: 98,8 x 3 H cm	CPPRTA260501 CPPRTA260508	103	€ 4,56	
	PROFILO PER RIPIANI IN VETRO SPESSORE 6-10 mm NON BASCULANTE D: 131,8 x 3 H cm	CPPRTA260801 CPPRTA260808	103	€ 6,03	
	PROFILO PER RIPIANI IN VETRO SPESSORE 8-12 mm NON BASCULANTE D: 98,8 x 4 H cm	CPPR04601001 CPPR04601008	103	€ 5,55	
	PROFILO PER RIPIANI IN VETRO SPESSORE 8-12 mm NON BASCULANTE D: 131,8 x 4 H cm	CPPR04601301 CPPR04601308	103	€ 7,32	
	PROFILO PER RIPIANI IN VETRO SPESSORE 8-12 mm BASCULANTE D: 98,8 x 4 H cm	CPPRTVB41001 CPPRTVB41008	103	€ 6,21	
	PROFILO PER RIPIANI IN VETRO SPESSORE 8-12 mm BASCULANTE D: 131,8 x 4 H cm	CPPRTVB41301 CPPRTVB41308	103	€ 8,20	

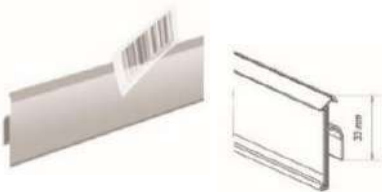

# COMUNICAZIONE PREZZO

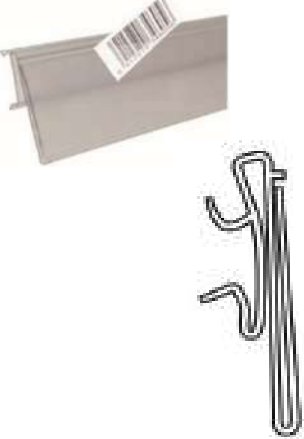
IMMAGINE	DESCRIZIONE	CODICE E COLORE	PAG CAT	PREZZO	NOTE
	PROFILO ALSER CON RETRO ALETTA D: 98,8 x 4 H cm	CPPRALG31001 CPPRALG31008	103	€ 3,79	
	PROFILO ALSER CON RETRO ALETTA D: 131,8 x 4 H cm	CPPRALG31301 CPPRALG31308	103	€ 5,01	
	PORTA BROCHE CON CAVA UNIVERSALE D: 6 x 4 H cm	CPPR04126001 CPPR04126008	103	€ 0,25	
	PORTA BROCHE CON CAVA UNIVERSALE D: 6,5 x 4 H cm	CPPR04126501 CPPR04126508	103	€ 0,27	
	PORTA BROCHE CON CAVA UNIVERSALE D: 7,5 x 4 H cm	CPPR04127501 CPPR04127508	103	€ 0,31	
	PROFILO PORTA PREZZO BASCULANTE INTRAC D: 98,8 x 4 H cm	CPPRTRC11001 CPPRTRC11008	104	€ 4,28	
	PROFILO PORTA PREZZO BASCULANTE INTRAC D: 131,8 x 4 H cm	CPPRTRC11301 CPPRTRC11308	104	€ 5,65	
	PROFILO PORTA PREZZO NUOVO INTRAC BASCULANTE D: 98,8 x 3 H cm *PER NUOVI RIPIANI INTRAC	CPPRTR310001 CPPRTR310008	104	€ 3,70	
	PROFILO PORTA PREZZO NUOVO INTRAC BASCULANTE D: 131,8 x 3 H cm *PER NUOVI RIPIANI INTRAC	CPPRTR311301 CPPRTR311308	104	€ 4,88	
	PROFILO PORTA PREZZO NUOVO INTRAC BASCULANTE D: 98,8 x 4 H cm *PER NUOVI RIPIANI INTRAC	CPPRTR410001 CPPRTR410008	104	€ 4,39	
	PROFILO PORTA PREZZO NUOVO INTRAC BASCULANTE D: 131,8 x 4 H cm *PER NUOVI RIPIANI INTRAC	CPPRTR411301 CPPRTR411308	104	€ 5,80	



# COMUNICAZIONE PREZZO

IMMAGINE	DESCRIZIONE	CODICE E COLORE	PAG CAT	PREZZO	NOTE
	PROFILO PORTA PREZZO COSTAN D: 100 x 4 H cm	CPPRCS412401 CPPRCS412408	104	€ 4,45	
	PROFILO PORTA PREZZO COSTAN D: 125 x 4 H cm	CPPRCS412501 CPPRCS412508	104	€ 5,56	
	PROFILO PORTA PREZZO COSTAN D: 131,8 x 4 H cm	CPPRCS411301 CPPRCS411308	104	€ 5,87	
	PROFILO PORTA PREZZO REVERSE CON ADESIVO D: 100 x 3H cm	CPPPRE321001 CPPPRE321008	104	€ 7,96	
	PROFILO PORTA PREZZO REVERSE CON ADESIVO D: 131,8 x 3 H cm	CPPPRE321301 CPPPRE321308	104	€ 10,50	
	PROFILO PORTA PREZZO REVERSE CON ADESIVO D: 100 x 4 H cm	CPPPRE451001 CPPPRE451008	104	€ 7,00	
	PROFILO PORTA PREZZO REVERSE CON ADESIVO D: 131,8 x 4 H cm	CPPPRE451301 CPPPRE451308	104	€ 9,23	
	BANDA COLORATA PER PROFILI PORTA PREZZO IN PVC SPESSORE 0,2 mm D: 2,6 x 10000 cm	CPPRBCOP2602 CPPRBCOP2603 CPPRBCOP2606 CPPRBCOP2607	104	SP	
	BANDA COLORATA PER PROFILI PORTA PREZZO IN PVC SPESSORE 0,2 mm D: 3,9 x 10000 cm	CPPRBCOP3902 CPPRBCOP3903 CPPRBCOP3906 CPPRBCOP3907	104	€ 54,25	



# COMUNICAZIONE PREZZO

IMMAGINE	DESCRIZIONE	CODICE E COLORE	PAG CAT	PREZZO	NOTE
	BANDA COLORATA PER PROFILI PORTA PREZZO IN CARTONCINO 200 gr D: 3,8 x 10000 cm *PERSONALIZZABILE	CPPRBC0C38	104	SP	ORDINE MINIMO: 30 RT
	BANDA COLORATA PER PROFILI PORTA PREZZO IN CARTONCINO 200 gr D: 3,9 x 10000 cm *PERSONALIZZABILE	CPPRBC0C39	104	SP	ORDINE MINIMO: 30 RT
	PROFILO ADESIVO TRASPARENTE PER ETICHETTA ELETTRONICA TIPO 4 L: 98,8 cm	CPEL431008	106	SP	
	PROFILO ADESIVO TRASPARENTE PER ETICHETTA ELETTRONICA TIPO 4 L: 131,8 cm	CPEL431308	106	SP	
	PROFILO ADESIVO TRASPARENTE PER ETICHETTA ELETTRONICA TIPO 2 L: 98,8 cm	CPEL231008	106	SP	
	PROFILO ADESIVO TRASPARENTE PER ETICHETTA ELETTRONICA TIPO 2 L: 131,8 cm	CPEL231308	106	SP	
	PROFILO ADESIVO TRASPARENTE PER ETICHETTA ELETTRONICA TIPO 3 L: 98,8 cm	CPEL331008	107	SP	
	PROFILO ADESIVO TRASPARENTE PER ETICHETTA ELETTRONICA TIPO 3 L: 131,8 cm	CPEL331308	107	SP	

# COMUNICAZIONE PREZZO

IMMAGINE	DESCRIZIONE	CODICE E COLORE	PAG CAT	PREZZO	NOTE
	PROFILO ADESIVO TRASPARENTE PER ETICHETTA ELETTRONICA TIPO 6 L: 98,8 cm	CPEL631008	107	SP	
	PROFILO ADESIVO TRASPARENTE PER ETICHETTA ELETTRONICA TIPO 6 L: 131,8 cm	CPEL631308	107	SP	
	PROFILO ADESIVO TRASPARENTE PER ETICHETTA ELETTRONICA TIPO 5 L: 98,8 cm	CPEL531008	107	SP	
	PROFILO ADESIVO TRASPARENTE PER ETICHETTA ELETTRONICA TIPO 5 L: 131,8 cm	CPEL531308	107	SP	

# COMUNICAZIONE GLOBALE

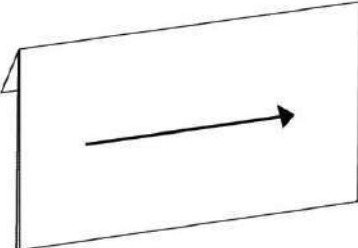
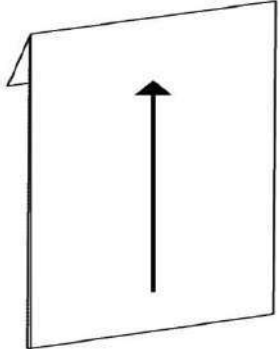
IMMAGINE	DESCRIZIONE	CODICE E COLORE	PAG CAT	PREZZO	NOTE
	TASCA COPRI ETICHETTE ELETTRONICHE IN PVC D: 11 x 8 H cm	CGTE LH0708	111	SP	
	TASCA PER CARTELLINO CON ATTACCHI GRIPPER IN PVC D: MISURE PERSONALIZZABILI	CGTGRXXX08	111	SP	
	TASCA ORIZZONTALE PER PROFILI SCANNER IN PVC ANTIRIFLESSO SPESSORE 0,3 mm D: 14,8 x 10,5 cm	CGPSAH0608	111	€ 1,70	
	TASCA ORIZZONTALE PER PROFILI SCANNER IN PVC ANTIRIFLESSO SPESSORE 0,3 mm D: 21 x 14,8 cm	CGPSAH0508	111	€ 2,05	
	TASCA ORIZZONTALE PER PROFILI SCANNER IN PVC ANTIRIFLESSO SPESSORE 0,3 mm D: 29,7 x 21 cm	CGPSAH0408	111	€ 2,40	
	TASCA VERTICALE PER PROFILI SCANNER IN PVC ANTIRIFLESSO SPESSORE 0,3 mm D: 10,5 x 14,8 cm	CGPSAV0608	111	€ 1,70	
	TASCA VERTICALE PER PROFILI SCANNER IN PVC ANTIRIFLESSO SPESSORE 0,3 mm D: 14,8 x 21 cm	CGPSAV0508	111	€ 2,05	
	TASCA VERTICALE PER PROFILI SCANNER IN PVC ANTIRIFLESSO SPESSORE 0,3 mm D: 21 x 29,7 cm	CGPSAV0408	111	€ 2,40	

# COMUNICAZIONE GLOBALE

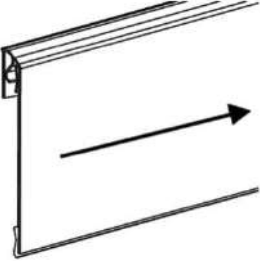
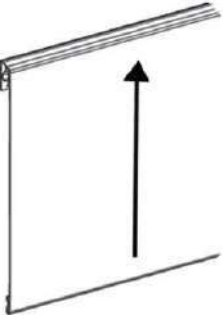
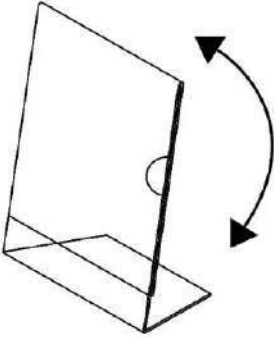
IMMAGINE	DESCRIZIONE	CODICE E COLORE	PAG CAT	PREZZO	NOTE
	TASCA ORIZZONTALE PER PROMO STOP BASCULANTE IN PVC ANTIRIFLESSO SPESSORE 0,3 mm D: 14,8 x 10,5 cm	CGPSABH608	111	€ 2,16	
	TASCA ORIZZONTALE PER PROMO STOP BASCULANTE IN PVC ANTIRIFLESSO SPESSORE 0,3 mm D: 21 x 14,8 cm	CGPSABH508	111	€ 2,46	
	TASCA VERTICALE PER PROMO STOP BASCULANTE IN PVC ANTIRIFLESSO SPESSORE 0,3 mm D: 10,5 x 14,8 cm	CGPSABV608	111	€ 2,10	
	TASCA VERTICALE PER PROMO STOP BASCULANTE IN PVC ANTIRIFLESSO SPESSORE 0,3 mm D: 14,8 x 21 cm	CGPSABV508	111	€ 2,40	
	ESPOSITORE PORTA MESSAGGI REVERSIBILE IN PET SPESSORE 2 mm D: 29,7 x 42 cm	CGEBA3VR08	111	SP	
	ESPOSITORE PORTA MESSAGGI REVERSIBILE IN PET SPESSORE 2 mm D: 21 x 29,7 cm	CGEBA4VR08	111	€ 13,25	
	ESPOSITORE PORTA MESSAGGI REVERSIBILE IN PET SPESSORE 2 mm D: 14,8 x 21 cm	CGEBA5VR08	111	€ 9,10	
	ESPOSITORE PORTA MESSAGGI REVERSIBILE IN PET SPESSORE 2 mm D: 10,5 x 14,8 cm	CGEBA6VR08	111	€ 4,40	

# COMUNICAZIONE GLOBALE

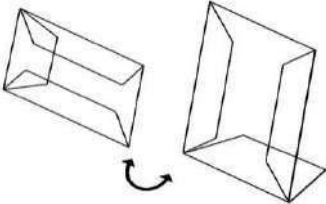
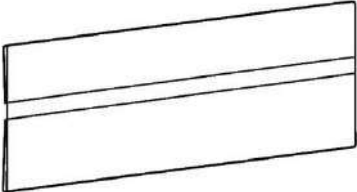
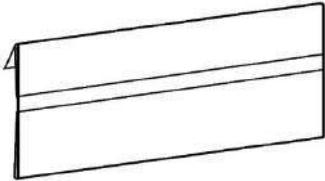
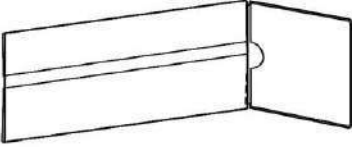

IMMAGINE	DESCRIZIONE	CODICE E COLORE	PAG CAT	PREZZO	NOTE
	ESPOSITORE PORTA MESSAGGI REVERSIBILE IN ACR SPESSORE 1 mm D: 21 x 29,7 cm	CGEBA4VH08	111	€ 12,60	
	ESPOSITORE PORTA MESSAGGI REVERSIBILE IN ACR SPESSORE 1 mm D: 14,8 x 21 cm	CGEBA5VH08	111	€ 6,30	
	PROMOSTOP NON TERMOSALDATO FISSO PER RIPIANI IN PVC D: 15 x 8 cm	CGPSTF0108	1113	€ 2,50	
	PROMOSTOP NON TERMOSALDATO FISSO PER RIPIANI IN PVC D: 18 x 8 cm	CGPSTF0208	113	€ 2,58	
	PROMOSTOP NON TERMOSALDATO BASCULANTE PER RIPIANI IN PVC D: 15 x 8 cm	CGPSTB1008	113	€ 2,90	
	PROMOSTOP NON TERMOSALDATO BASCULANTE PER RIPIANI IN PVC D: 18 x 8 cm	CGPSTB0208	113	€ 2,99	
	PROMOSTOP FISSO TERMOSALDATO CON BUSTA 8 x 8 A BANDIERA IN PVC D: 8 x 8 cm	CGPSTF0308	113	SP	
	PROMOSTOP FISSO TERMOSALDATO CON BUSTA 8 x 8 A BANDIERA IN PVC D: 11 x 8 cm	CGPSTF0408	113	SP	
	PROMOSTOP FISSO TERMOSALDATO CON BUSTA 8 x 8 A BANDIERA IN PVC D: 15 x 8 cm	CGPSTF0508	113	SP	
	PROMOSTOP FISSO TERMOSALDATO CON BUSTA 8 x 8 A BANDIERA IN PVC D: 18 x 8 cm	CGPSTF0608	113	SP	

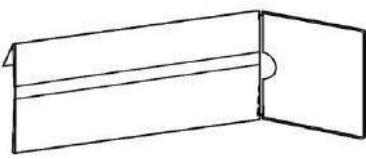
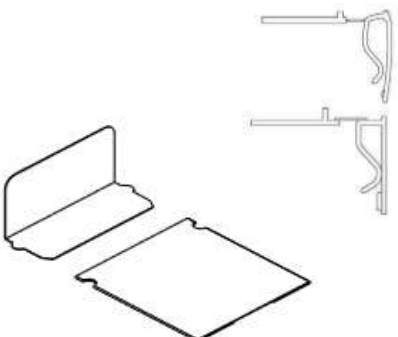
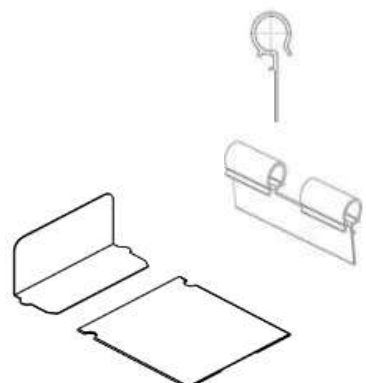
# COMUNICAZIONE GLOBALE



IMMAGINE	DESCRIZIONE	CODICE E COLORE	PAG CAT	PREZZO	NOTE
	PROMOSTOP BASCULANTE TERMOSALDATO CON BUSTA 8 x 8 A BANDIERA IN PVC D: 8 x 8 cm	CGPSTB0308	113	SP	
	PROMOSTOP BASCULANTE TERMOSALDATO CON BUSTA 8 x 8 A BANDIERA IN PVC D: 11 x 8 cm	CGPSTB0408	113	SP	
	PROMOSTOP BASCULANTE TERMOSALDATO CON BUSTA 8 x 8 A BANDIERA IN PVC D: 15 x 8 cm	CGPSTB0508	113	SP	
	PROMOSTOP BASCULANTE TERMOSALDATO CON BUSTA 8 x 8 A BANDIERA IN PVC D: 18 x 8 cm	CGPSTB0608	113	SP	
	PROMOSTOP CON BANDIERA PROMOZIONALE AD INCASTRO IN PPL D: 8 x 8 cm *CON PROFILO BASCULANTE LARGO/STRETTO CON BANDA SILICONICA * PERSONALIZZABILE	CGBITBXX08	114	SP	
	PROMOSTOP CON BANDIERA PROMOZIONALE AD INCASTRO IN PPL E ATTACCO PORTA BROCHE D: 8 x 8 cm *CON PROFILO BASCULANTE LARGO/STRETTO CON BANDA SILICONICA * PERSONALIZZABILE	CGFITFXX08	114	SP	

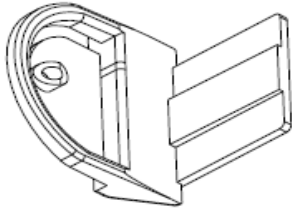
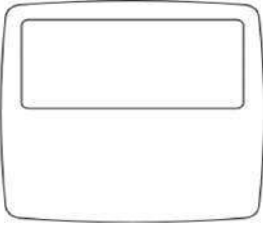

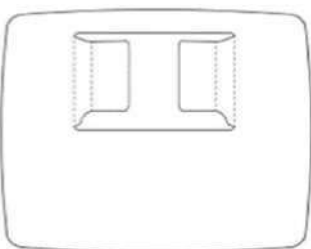

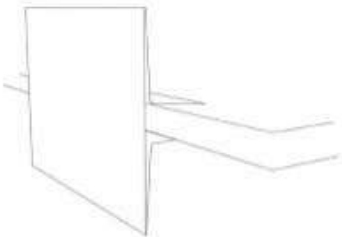
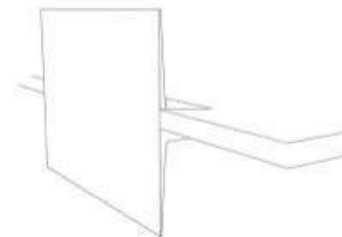
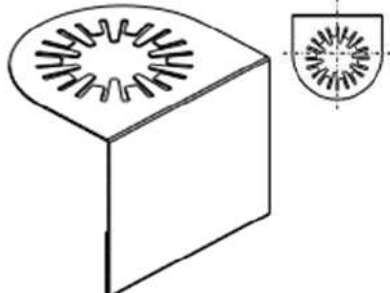
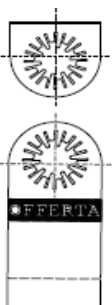

# COMUNICAZIONE GLOBALE

IMMAGINE	DESCRIZIONE	CODICE E COLORE	PAG CAT	PREZZO	NOTE
	SUPPLEMENTO PER PROMOSTOP PER ETICHETTE ELETTRONICHE DESTRO O SINISTRO CON ATTACCO A FORO IN POM *PERSONALIZZABILE	CGALPE0501	115	€ 21,00	CONF DA 25 PZ
	PROMOSTOP PER ETICHETTE ELETTRONICHE IN PPL *PERSONALIZZABILE	CGPSEEXX99	115	SP	CONF DA 25 PZ
	PROMOSTOP AD INCASTRO PER ETICHETTE ELETTRONICHE IN PPL *PERSONALIZZABILE	CGPSIEXX99	115	SP	CONF DA 25 PZ
	PROMOSTOP PER ETICHETTE ELETTRONICHE MONOFACCIALE IN PPL *PERSONALIZZABILE	CGPSDFMXX99	116	SP	CONF DA 25 PZ
	PROMOSTOP PER ETICHETTE ELETTRONICHE BIFACCIALE IN PPL *PERSONALIZZABILE	CGPSDFBX99	116	SP	CONF DA 25 PZ
	PROMOSTOP PER ETICHETTE ELETTRONICHE MONOFACCIALE IN PPL *PERSONALIZZABILE	CGPSEEMX99	116	SP	CONF DA 25 PZ
	PROMOSTOP PER ETICHETTE ELETTRONICHE BIFACCIALE IN PPL *PERSONALIZZABILE	CGPSEEBX99	116	SP	CONF DA 25 PZ

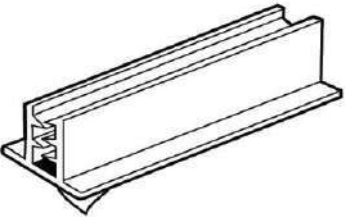

# COMUNICAZIONE GLOBALE

IMMAGINE	DESCRIZIONE	CODICE E COLORE	PAG CAT	PREZZO	NOTE
	PROMOSTOP IN PPL PER RIPIANI IN LEGNO *SPECIFICARE LO SPESSORE DEL PIANO E DEL CARTELLINO	CGPSWD0208	117	SP	CONF DA 25 PZ
	PROMOSTOP IN PPL PER RIPIANI IN VETRO *SPECIFICARE LO SPESSORE DEL PIANO E DEL CARTELLINO	CGPSGL0108	117	SP	CONF DA 25 PZ
	PROMOSTOP IN PPL PER BOTTIGLIE DIMENSIONI CARTELLINO: 8,4 x 5,6 cm *NEUTRO	CGPSWN8608	117	€ 29,14	CONF DA 25 PZ
	PROMOSTOP "OFFERTA" IN PPL PER BOTTIGLIE DIMENSIONI CARTELLINO: 8,4 x 5,6 cm *PERSONALIZZABILE SU PREVENTIVO	CGPSWN8508	117	€ 37,46	CONF DA 25 PZ
	PROMOSTOP FUSTELLATO "OFFERTA" IN PPL STOPPER: 7,8 x 6,7 cm STRISCIA: 15 x 3 cm MISURE APERTO: 46,5 x 6,7 cm	CGPSST0199	118	SP	CONF DA 25 PZ

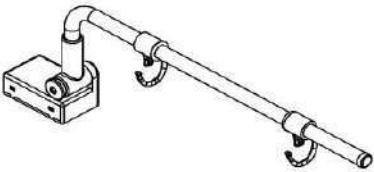

# COMUNICAZIONE GLOBALE

IMMAGINE	DESCRIZIONE	CODICE E COLORE	PAG CAT	PREZZO	NOTE
	<p>PROMOSTOP FUSTELLATO "100% BIO" IN PPL</p> <p>STOPPER: 13 x 16 cm STRISCIA: 6,7 x 3,2 cm MISURE APERTO: 26,3 x 16 cm</p>	CGPSST0299	118	SP	CONF DA 25 PZ
	<p>ATTACCHI PROMOSTOP DOPPIO IN PVC PER CARTELLI</p> <p>D: 25 x 20 mm</p>	CGPS001108	119	€ 10,38	CONF DA 25 PZ
	<p>ATTACCHI PROMO STOP A BANDIERA PER CARTELLI A PROFILO PERPENDICOLARI CON BIADESIVO IN PVC</p> <p>D: 1,3 x 2,5 x 1,1 cm *ADATTO PER CARTELLI CON FORO DA 3 mm</p>	CGPS001008	119	€ 1,50	
	<p>ATTACCHI PROMO STOP A BANDIERA PER CARTELLI A PROFILO "ELETTRONICI" PERPENDICOLARI IN PP</p> <p>*ADATTO PER CARTELLI CON FORO DA 5 mm</p>	CGPS074108	119	€ 10,40	CONF DA 25 PZ
	<p>ATTACCHI PROMO STOP A BANDIERA PER CARTELLI A PROFILO "CARTACEI" PERPENDICOLARI IN PP</p> <p>*ADATTO PER CARTELLI CON FORO DA 5 mm</p>	CGPS004108	119	€ 10,40	CONF DA 25 PZ

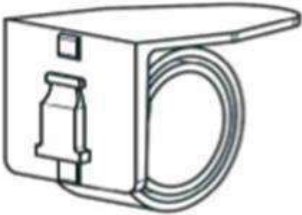
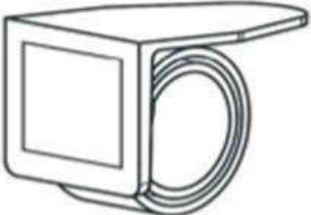
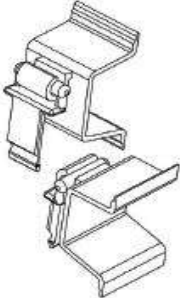
# COMUNICAZIONE GLOBALE

IMMAGINE	DESCRIZIONE	CODICE E COLORE	PAG CAT	PREZZO	NOTE
	PORTA BANNER ORIENTABILE 0-180° A BASE MAGNETICA IN AL L: 27 cm	CGPSPB0101	119	€ 5,60	
	ATTACCHI PROMO STOP A BANDIERA PER CARTELLI A PROFILO PERPENDICOLARI IN PVC *ADATTO PER CARTELLI CON FORO DA 3 mm	CGPS000908	119	€ 0,44	
	CLIP A CHIOCCIOLA PER RIPIANI CON ADATTATORE VERTICALE IN PC+POM	CPAACLC101	119	€ 26,75	CONF DA 25 PZ
	CLIP A CHIOCCIOLA PER RIPIANI CON ADESIVO IN PC+POM	CPAACLC201	119	€ 26,75	CONF DA 25 PZ
	CLIP IN PLASTICA BASCULANTE UNIVERSALE PER CURSORE A "C" SCAFFALI H 30 mm	CPAABSC001 CPAABSC005	119	€ 15,00	CONF DA 25 PZ

# COMUNICAZIONE GLOBALE

IMMAGINE	DESCRIZIONE	CODICE E COLORE	PAG CAT	PREZZO	NOTE
	ATTACCO A VENTOSA CON PINZA PORTA MESSAGGI SNODABILE	CGPSHS0401	CAT 2020	€ 18,43	
	GANCIO TRILLO PORTA BLISTER PER RIPIANI FORATI PASSO 25 mm IN PC L: 8 cm	CMSEGTB108	CAT 2020	€ 1,58	
	CORNICE A6 IN ABS CON APERTURA LATO CORTO D: 10,5 x 14,8 cm	CPCRA60001 CPCRA60002 CPCRA60003 CPCRA60004 CPCRA60005 CPCRA60006 CPCRA60007 CPCRA60008	121	€ 9,80	CONF DA 10 PZ
	CORNICE A5 CON APERTURA LATO CORTO IN ABS D: 14,8 x 21 cm	CPCRA50001 CPCRA50002 CPCRA50003 CPCRA50004 CPCRA50005 CPCRA50006 CPCRA50007 CPCRA50008	121	€ 16,60	CONF DA 10 PZ
	CORNICE A4 CON APERTURA LATO CORTO IN ABS D: 21 x 29,7 cm	CPCRA40001 CPCRA40002 CPCRA40003 CPCRA40004 CPCRA40005 CPCRA40006 CPCRA40007 CPCRA40008	121	€ 19,60	CONF DA 10 PZ
	CORNICE A3 CON APERTURA LATO CORTO IN ABS D: 29,7 x 42 cm	CPCRA30001 CPCRA30002 CPCRA30003 CPCRA30004 CPCRA30005 CPCRA30006 CPCRA30007 CPCRA30008	121	€ 31,70	CONF DA 10 PZ

# COMUNICAZIONE GLOBALE

IMMAGINE	DESCRIZIONE	CODICE E COLORE	PAG CAT	PREZZO	NOTE
 <p>*COMPLETAMENTE PERSONALIZZABILI</p>	EVIDENZIATORE PER CORNICI "OFFERTA" ORIZZONTALE A3	CGECA30FHD	122	SP	
	EVIDENZIATORE PER CORNICI "OFFERTA" ORIZZONTALE A4	CGECA40FHD	122	SP	
	EVIDENZIATORE PER CORNICI "OFFERTA" ORIZZONTALE A5	CGECA50FHD	122	SP	
 <p>*COMPLETAMENTE PERSONALIZZABILI</p>	EVIDENZIATORE PER CORNICI "OFFERTA" VERTICALE A3	CGECA30FVD	122	SP	
	EVIDENZIATORE PER CORNICI "OFFERTA" VERTICALE A4	CGECA40FVD	122	SP	
	EVIDENZIATORE PER CORNICI "OFFERTA" VERTICALE A5	CGECA50FVD	122	SP	
 <p>*COMPLETAMENTE PERSONALIZZABILI</p>	EVIDENZIATORE PER CORNICI "NOVITÀ" ORIZZONTALE A3	CGECA3NVHD	122	SP	
	EVIDENZIATORE PER CORNICI "NOVITÀ" ORIZZONTALE A4	CGECA4NVHD	122	SP	
	EVIDENZIATORE PER CORNICI "NOVITÀ" ORIZZONTALE A5	CGECA5NVHD	122	SP	
 <p>*COMPLETAMENTE PERSONALIZZABIL</p>	EVIDENZIATORE PER CORNICI "NOVITÀ" VERTICALE A3	CGECA3NVVD	122	SP	
	EVIDENZIATORE PER CORNICI "NOVITÀ" VERTICALE A4	CGECA4NVVD	122	SP	
	EVIDENZIATORE PER CORNICI "NOVITÀ" VERTICALE A5	CGECA5NVVD	122	SP	

# COMUNICAZIONE GLOBALE

IMMAGINE	DESCRIZIONE	CODICE E COLORE	PAG CAT	PREZZO	NOTE
	TASCA A3 ANTIRIFLESSO IN PVC SPESSORE 0,3 mm	CPAATS0308	122	€ 23,74	CONF DA 10 PZ
	TASCA A4 ANTIRIFLESSO IN PVC SPESSORE 0,3 mm	CPAATS0408	122	€ 12,32	CONF DA 10 PZ
	TASCA A5 ANTIRIFLESSO IN PVC SPESSORE 0,3 mm	CPAATS0508	122	€ 8,99	CONF DA 10 PZ
	TASCA A6 ANTIRIFLESSO IN PVC SPESSORE 0,3 mm	CPAATS0608	122	€ 5,60	CONF DA 10 PZ
	TASCA A7 ANTIRIFLESSO IN PVC SPESSORE 0,3 mm	CPAATS0708	122	€ 4,80	CONF DA 10 PZ
	ATTACCO BASCULANTE PER CORNICI CON BASE MAGNETICA IN PC	CPAAS02108	123	€ 18,40	CONF DA 10 PZ
	PINZA A MOLLA CON ATTACCO A "T" PER CORNICI IN PC	CPAAPM0108	123	€ 37,80	CONF DA 10 PZ
	ATTACCO A GANCIO PER CORNICI IN PC	CPAA000108	123	€ 4,62	CONF DA 10 PZ

# COMUNICAZIONE GLOBALE

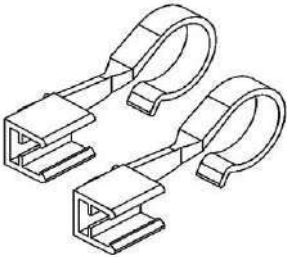
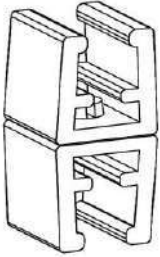
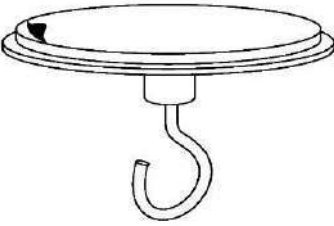
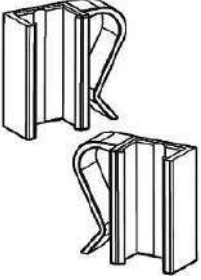
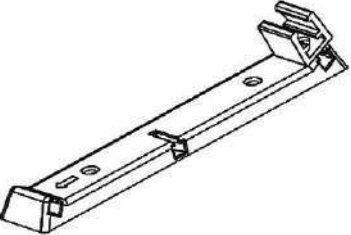
IMMAGINE	DESCRIZIONE	CODICE E COLORE	PAG CAT	PREZZO	NOTE
	COPPIA DI GANCI PER CORNICI AD UNCINO IN PC	CPAA000208	123	€ 13,49	CONF DA 20 PZ *10 GANCI SX *10 GANCI DX
	CONNETTORE PER CORNICI IN PC	CPAA000308	123	€ 3,50	CONF DA 10 PZ
	SUPPORTO A GANCIO CON BASE MAGNETICA IN ABS+ST	CPAA174T01	123	€ 19,98	CONF DA 10 PZ
	ATTACCO LATERALE PER CESTE IN FILO METALLICO IN PC	CPAAVWC108	123	€ 14,99	CONF DA 20 PZ *10 GANCI SX *10 GANCI DX
	PIEDISTALLO PER ESPOSIZIONE CORNICE INCLINATA IN PC	CPAA000708	123	€ 9,86	CONF DA 10 PZ

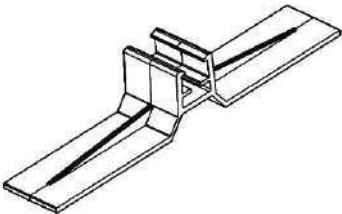
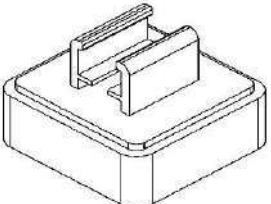
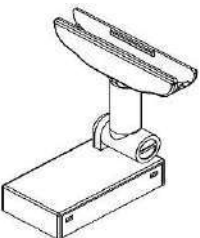
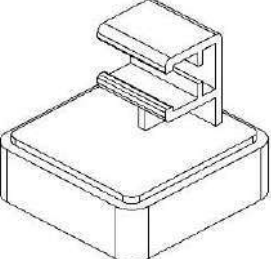
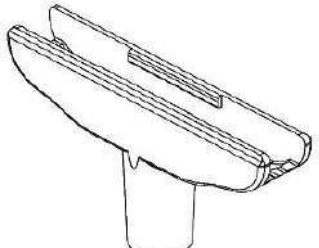

# COMUNICAZIONE GLOBALE

IMMAGINE	DESCRIZIONE	CODICE E COLORE	PAG CAT	PREZZO	NOTE
	PIEDISTALLO PER ESPOSIZIONE CORNICE VERTICALE IN PC	CPAA001708	124	€ 9,42	CONF DA 10 PZ
	SUPPORTO PORTA CORNICE CON BASE MAGNETICA PER ESPOSIZIONE A BANDIERA IN ABS+PC	CPAA007001	124	€ 9,86	CONF DA 10 PZ
	ATTACCO A "T" ORIENTABILE 0-180° CON BASE MAGNETICA IN ABS+PC	CPAAT00101	124	€ 26,64	CONF DA 10 PZ
	SUPPORTO PORTA CORNICE CON BASE MAGNETICA PER ESPOSIZIONE FRONTALE IN ABS+PC	CPAA070B01	124	€ 9,10	CONF DA 10 PZ
	ATTACCO A "T" STANDARD PER CORNICI UNIVERSALE IN PC	CPAAT00308	124	€ 6,70	CONF DA 10 PZ



# COMUNICAZIONE GLOBALE

IMMAGINE	DESCRIZIONE	CODICE E COLORE	PAG CAT	PREZZO	NOTE
	ATTACCO A "T" PER CORNICE ORIENTABILE IN ABS+ST	CPAAT00208	124	€ 12,66	CONF DA 10 PZ
	ATTACCO A CORNICE PER SUPPORTI PROMOZIONALI IN PC	CGATCSPR08	124	€ 2,90	CONF DA 10 PZ
	PINZA IN PC TRASPARENTE ORIENTABILE PER CORNICI PER BARRE CILINDRICHE D: MAX 30 mm	CPATCSP708	124	€ 42,40	CONF DA 10 PZ
	PINZA IN PC TRASPARENTE SENZA BRACCIO PER CORNICI PER BARRE CILINDRICHE D: MAX 30 mm	CPATCOPZ08	124	€ 36,00	CONF DA 10 PZ
	PIANTANA ECONOMICA CON BASE IN PLASTICA ESTENSIBILE CON ASTA E ATTACCO A "T" ORIENTABILE 0-180° IN ABS+AL L: DA 30 A 60 cm	CPAAES3001	125	€ 81,18	CONF DA 10 PZ
	PIANTANA ECONOMICA CON BASE IN PLASTICA ESTENSIBILE CON ASTA E ATTACCO A "T" ORIENTABILE 0-180° IN ABS+AL L: DA 50 A 10 cm	CPAAES5001	125	€ 84,58	CONF DA 10 PZ

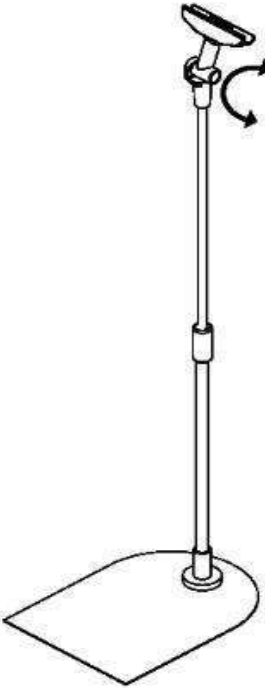

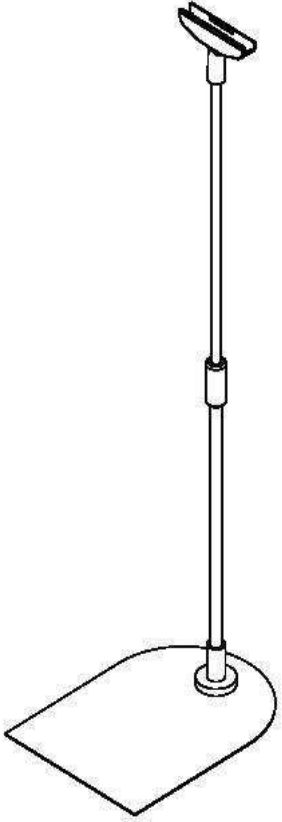

# COMUNICAZIONE GLOBALE

IMMAGINE	DESCRIZIONE	CODICE E COLORE	PAG CAT	PREZZO	NOTE
	PIANTANA ECONOMICA CON BASE IN PLASTICA ESTENSIBILE CON ASTA E ATTACCO A "T" STANDARD IN ABS+AL L: DA 30 A 60 cm	CPAAEF3001	125	€ 74,96	CONF DA 10 PZ
	PIANTANA ECONOMICA CON BASE IN PLASTICA ESTENSIBILE CON ASTA E ATTACCO A "T" STANDARD IN ABS+AL L: DA 50 A 100 cm	CPAAEF5001	125	€ 76,22	CONF DA 10 PZ
	PIANTANA STANDARD CON BASE IN METALLO ESTENSIBILE CON ASTA E ATTACCO A "T" ORIENTABILE 0-180° IN ABS+AL+FE L: DA 30 A 60 cm	CPAAFS3022	125	€ 91,18	CONF DA 10 PZ
	PIANTANA STANDARD CON BASE IN METALLO ESTENSIBILE CON ASTA E ATTACCO A "T" ORIENTABILE 0-180° IN ABS+AL+FE L: DA 50 A 100 cm	CPAAFS5022	125	€ 94,63	CONF DA 10 PZ
	PIANTANA STANDARD CON BASE IN METALLO ESTENSIBILE CON ASTA E ATTACCO A "T" ORIENTABILE 0-180° IN ABS+AL+FE L: DA 75 A 150 cm	CPAAFS7522	125	€ 102,00	CONF DA 10 PZ



# COMUNICAZIONE GLOBALE

IMMAGINE	DESCRIZIONE	CODICE E COLORE	PAG CAT	PREZZO	NOTE
	PIANTANA STANDARD CON BASE IN METALLO ESTENSIBILE CON ASTA E ATTACCO A "T" STANDARD IN ABS+AL+FE L: DA 30 A 60 cm	CPAAFF3022	125	€ 84,58	CONF DA 10 PZ
	PIANTANA STANDARD CON BASE IN METALLO ESTENSIBILE CON ASTA E ATTACCO A "T" STANDARD IN ABS+AL+FE L: DA 50 A 100 cm	CPAAFF5022	125	€ 87,58	CONF DA 10 PZ
	PIANTANA STANDARD CON BASE IN METALLO ESTENSIBILE CON ASTA E ATTACCO A "T" STANDARD IN ABS+AL+FE L: DA 75 A 150 cm	CPAAFF7522	125	€ 93,90	CONF DA 10 PZ
	PIANTANA PER CESTI IN FILO METALLICO ESTENSIBILE CON ASTA E ATTACCO A "T" ORIENTABILE 0-180° IN ABS+AL L: DA 30 A 60 cm	CPAACS3012	125	€ 64,20	CONF DA 10 PZ
	PIANTANA PER CESTI IN FILO METALLICO ESTENSIBILE CON ASTA E ATTACCO A "T" ORIENTABILE 0-180° IN ABS+AL L: DA 50 A 100 cm	CPAACS5012	125	€ 66,20	CONF DA 10 PZ

# COMUNICAZIONE GLOBALE

IMMAGINE	DESCRIZIONE	CODICE E COLORE	PAG CAT	PREZZO	NOTE
	PIANTANA PER CESTI IN FILO METALLICO ESTENSIBILE CON ASTA E ATTACCO A "T" STANDARD IN ABS+AL L: DA 30 A 60 cm	CPAACF3012	125	€ 52,50	CONF DA 10 PZ
	PIANTANA PER CESTI IN FILO METALLICO ESTENSIBILE CON ASTA E ATTACCO A "T" STANDARD IN ABS+AL L: DA 50 A 100 cm	CPAACF5012	125	€ 55,00	CONF DA 10 PZ
	BRACCIO SUPPLEMENTARE PER PIANTANE IN AL L: 50 cm	CPAAB05012	125	SP	
	BRACCIO SUPPLEMENTARE PER PIANTANE IN AL L: 100 cm	CPAAB10012	125	SP	
	COPPIA DI GANCI PER BRACCIO SUPPLEMENTARE PER FOGLI IN PVC	CPAAHP0008	125	SP	CONF DA 20 PZ

# COMUNICAZIONE GLOBALE

IMMAGINE	DESCRIZIONE	CODICE E COLORE	PAG CAT	PREZZO	NOTE
	FOGLIO PROTETTIVO PER CORNICI IN PVC ANTIRIFLESSO PER USO INTERNO D: 50 x 70 cm	CGCAPSB108	126	€ 3,30	
	FOGLIO PROTETTIVO PER CORNICI IN PVC ANTIRIFLESSO PER USO INTERNO D MAX: 70 x 100 cm	CGCAPSB208	126	€ 6,60	
	FOGLIO PROTETTIVO PER CORNICI IN PET PER USO ESTERNO D: 50 x 70 cm	CGCAPEB108	126	€ 11,30	
	FOGLIO PROTETTIVO PER CORNICI IN PET PER USO ESTERNO D: 70 x 100 cm	CGCAPEB208	126	€ 19,98	
	CORNICE CLICK CLACK 25 CON ANGOLI TONDI CON TELAIO DA 2,5 cm IN AL PER USO INTERNO D: 21 x 29,7 cm	CGCAR20012	126	€ 13,30	
	CORNICE CLICK CLACK 25 CON ANGOLI TONDI CON TELAIO DA 2,5 cm IN AL PER USO INTERNO D: 29,7 x 42 cm	CGCAR20112	126	€ 21,35	
	CORNICE CLICK CLACK 25 CON ANGOLI TONDI CON TELAIO DA 2,5 cm IN AL PER USO INTERNO D: 50x 70 cm	CGCAR20312	126	€ 40,83	
	CORNICE CLICK CLACK 25 CON ANGOLI TONDI CON TELAIO DA 2,5 cm IN AL PER USO INTERNO D: 70x 100 cm	CGCAR20512	126	€ 62,25	

# COMUNICAZIONE GLOBALE

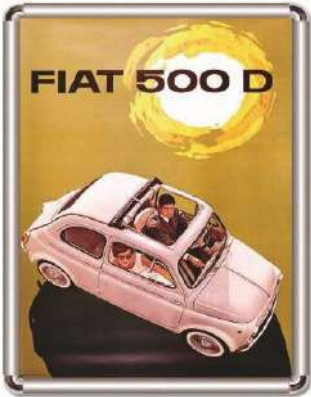
IMMAGINE	DESCRIZIONE	CODICE E COLORE	PAG CAT	PREZZO	NOTE
	CORNICE CLICK CLACK 32 CON ANGOLI TONDI CON TELAIO DA 3,2 cm IN AL PER USO INTERNO D: 50 x 70 cm	CGCAR30312	126	€ 48,85	
	CORNICE CLICK CLACK 32 CON ANGOLI TONDI CON TELAIO DA 3,2 cm IN AL PER USO INTERNO D: 70 x 100 cm	CGCAR30512	126	€ 86,87	
	CORNICE CLICK CLACK 32 CON ANGOLI TONDI CON TELAIO DA 3,2 cm IN AL PER USO INTERNO D: 100 x 140 cm	CGCAR30712	126	€ 119,17	
	CORNICE CLICK CLACK 32 CON ANGOLI TONDI CON TELAIO DA 3,2 cm IN AL PER USO ESTERNO D: 50 x 70 cm	CGCAER3312	126	€ 66,64	
	CORNICE CLICK CLACK 32 CON ANGOLI TONDI CON TELAIO DA 3,2 cm IN AL PER USO ESTERNO D: 70 x 100 cm	CGCAE30512	126	€ 96,39	
	CORNICE CLICK CLACK 32 CON ANGOLI TONDI CON TELAIO DA 3,2 cm IN AL PER USO ESTERNO D: 100 x 140 cm	CGCAER3712	126	€ 163,20	

# COMUNICAZIONE GLOBALE

IMMAGINE	DESCRIZIONE	CODICE E COLORE	PAG CAT	PREZZO	NOTE
	INFO POSTER STAND DOPPIA FACCIA CON TELAIO DA 2,5 cm IN	CGCARD2005	127	€ 324,00	
	AL+ MDF PER USO INTERNO D: 65,4 x 33,7 x 174 cm D CORNICE: 50 x 70 cm	CGCARD2012	127	€ 388,00	
	INFO POSTER STAND DOPPIA FACCIA CON TELAIO DA 3,2 cm IN	CGCARD2105	127	€ 374,40	
	AL+ MDF PER USO INTERNO D: 65,4 x 33,7 x 174 cm D CORNICE:70 x 100 cm	CGCARD2112	127	€ 451,24	
	INFO POSTER STAND DOPPIA FACCIA CON TELAIO DA 2,5 cm IN	CGCAED2005	127	€ 349,20	
	AL+ MDF PER USO ESTERNO D: 65,4 x 33,7 x 174 cm D CORNICE: 50 x 70 cm	CGCAED2012	127	€ 410,31	
	INFO POSTER STAND DOPPIA FACCIA CON TELAIO DA 3,2 cm IN	CGCAED2105	127	€ 414,00	
	AL+ MDF PER USO ESTERNO D: 65,4 x 33,7 x 174 cm D CORNICE:70 x 100 cm	CGCAED2112	127	€ 504,90	
	INFO POSTER STAND SINGOLA FACCIA CON TELAIO DA 2,5 cm IN	CGCARM2005	127	€ 266,40	
	AL+ MDF PER USO INTERNO D: 65,4 x 33,7 x 174 cm D CORNICE: 50 x 70 cm	CGCARM2012	127	€ 354,00	
	INFO POSTER STAND SINGOLA FACCIA CON TELAIO DA 3,2 cm IN	CGCARM2005	127	€ 291,60	
	AL+ MDF PER USO INTERNO D: 65,4 x 33,7 x 174 cm D CORNICE:70 x 100 cm	CGCARM2012	127	€ 385,62	
	INFO POSTER STAND SINGOLA FACCIA CON TELAIO DA 2,5 cm IN	CGCARE2005	127	€ 280,80	
	AL+ MDF PER USO ESTERNO D: 65,4 x 33,7 x 174 cm D CORNICE: 50 x 70 cm	CGCARE2012	127	€ 373,67	
	INFO POSTER STAND SINGOLA FACCIA CON TELAIO DA 3,2 cm IN	CGCARE2105	127	€ 309,60	
	AL+ MDF PER USO ESTERNO D: 65,4 x 33,7 x 174 cm D CORNICE:70 x 100 cm	CGCARE2112	127	€ 412,45	







# COMUNICAZIONE GLOBALE

IMMAGINE	DESCRIZIONE	CODICE E COLORE	PAG CAT	PREZZO	NOTE
	WINDOW FRAME DOPPIA FACCIA CON FILM TRASPARENTE PROTETTIVO ANTIRIFLESSO D: 21 x 29,7 cm	PFSS25021030WF	127	SP	
	WINDOW FRAME DOPPIA FACCIA CON FILM TRASPARENTE PROTETTIVO ANTIRIFLESSO D: 29,7 x 42 cm	PFSS25030042WF	127	SP	
	WINDOW FRAME DOPPIA FACCIA CON FILM TRASPARENTE PROTETTIVO ANTIRIFLESSO D: 50 x 70 cm	PFSS25050070WF	127	€ 76,26	
	WINDOW FRAME DOPPIA FACCIA CON FILM TRASPARENTE PROTETTIVO ANTIRIFLESSO D: 70 x 100 cm	PFSS25070100WF	127	€ 96,24	
 <p>* DOPPIA CORNICE</p>	CORNICE A CAVALLETTO 32 CON ANGOLI TONDI E SCHIENALE IN POLISTIRENE IN AL+ST PER USO INTERNO D: 50 x 70 cm	CGCAAPR012	128	€ 174,59	
	CORNICE A CAVALLETTO 32 CON ANGOLI TONDI E SCHIENALE IN POLISTIRENE IN AL+ST PER USO INTERNO D: 70 x 100 cm	CGCAAPR112	128	€ 232,60	
	CORNICE A CAVALLETTO 32 CON ANGOLI TONDI E SCHIENALE IN POLISTIRENE IN AL+ST PER USO ESTERNO D: 50 x 70 cm	CGCAEPR012	128	€ 211,72	
	CORNICE A CAVALLETTO 32 CON ANGOLI TONDI E SCHIENALE IN POLISTIRENE IN AL+ST PER USO ESTERNO	CGCAEPR112	128	€ 273,71	
	CHALK BOARD A CAVALLETTO CON CORNICE IN LEGNO D: 66 x 99 cm	CGCACBW020	128	€ 234,94	



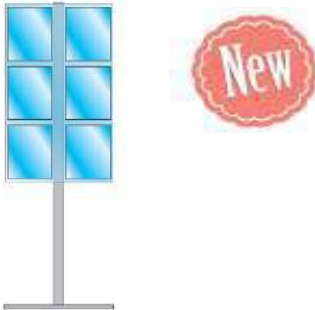

# COMUNICAZIONE GLOBALE

IMMAGINE	DESCRIZIONE	CODICE E COLORE	PAG CAT	PREZZO	NOTE
	POSTER SWING STRUTTURA IN METALLO CON CORNICE IN ALLUMINIO ANODIZZATO 46 mm PER USO INTERNO D CORNICE: 50 x 70 cm	SWSDR35050070	129	€ 293,37	
	POSTER SWING STRUTTURA IN METALLO CON CORNICE IN ALLUMINIO ANODIZZATO 46 mm PER USO INTERNO D CORNICE: 59,4 x 84,1 cm	SWSDR35060084	129	€ 262,73	
	POSTER SWING STRUTTURA IN METALLO CON CORNICE IN ALLUMINIO ANODIZZATO 46 mm PER USO INTERNO D CORNICE: 70 x 100 cm	SWSDR35070100	129	€ 333,87	
	POSTER SWING STRUTTURA IN METALLO CON CORNICE IN ALLUMINIO ANODIZZATO 46 mm PER USO INTERNO D CORNICE: 84,1 x 118,8 cm	SWSDR35084118	129	€ 472,53	
	POSTER SWING STRUTTURA IN METALLO CON CORNICE IN ALLUMINIO ANODIZZATO 46 mm PER USO ESTERNO D CORNICE: 50 x 70 cm	SWSDR35050070WP	129	€ 308,04	
	POSTER SWING STRUTTURA IN METALLO CON CORNICE IN ALLUMINIO ANODIZZATO 46 mm PER USO ESTERNO D CORNICE: 59,4 x 84,1 cm	SWSDR35060084WP	129	€ 275,10	
	POSTER SWING STRUTTURA IN METALLO CON CORNICE IN ALLUMINIO ANODIZZATO 46 mm PER USO ESTERNO D CORNICE: 70 x 100 cm	SWSDR35070100WP	129	€ 350,57	
	POSTER SWING STRUTTURA IN METALLO CON CORNICE IN ALLUMINIO ANODIZZATO 46 mm PER USO ESTERNO D CORNICE: 84,1 x 118,8 cm	SWSDR35084118WP	129	€ 496,16	

# COMUNICAZIONE GLOBALE



IMMAGINE	DESCRIZIONE	CODICE E COLORE	PAG CAT	PREZZO	NOTE
	PORTA INFORMAZIONI AD ANELLI IN AL+ST+PMMA FORMATO 2 x A4 D: 32 x 90 cm	CGCARI0012	129	€ 194,75	
	LEGGIO DA BANCO D: 45 x 30 h cm	CGCALG4508	129	€ 45,05	
	PIANTANA CON 6 TASCHE IN PVC BIADESIVIZZATE H: 170 cm	CGCADB6408	129	€ 461,08	
	ESPOSITORE METAL TESTATA PORTADEPLIANT CON TESTATA A BASE QUADRATA CON 8 CONTENITORI FORMATO A4 IN AL+ST	CGCADB84	130	€ 599,37	
	DYNAMIC POSTER STAND MONOFACCIALE CON CORNICE 50 x 70 CON ANGOLI VIVI E CON BASE QUADRATA IN AL D: 38 x 207 H cm	CGCAYM0012	130	€ 212,36	
	DYNAMIC POSTER STAND BIFACCIALE CON CORNICE 50 x 70 CON ANGOLI VIVI E CON BASE QUADRATA IN AL D: 38 x 207 H cm	CGCAYB0012	130	€ 248,99	

# COMUNICAZIONE GLOBALE

IMMAGINE	DESCRIZIONE	CODICE E COLORE	PAG CAT	PREZZO	NOTE
	DYNAMIC POSTER STAND MONOFACCIALE CON PORTADEPLIANT A3, CORNICE 50 x 70 CON ANGOLI VIVI E CON BASE QUADRATA IN AL D: 38 x 207 H cm	CGCAYM3012	130	€ 271,30	
	DYNAMIC POSTER STAND MONOFACCIALE CON 4 PORTADEPLIANT A4, CORNICE 50 x 70 CON ANGOLI VIVI E CON BASE QUADRATA IN AL D: 38 x 207 H cm	CGCAYM4012	130	€ 371,53	
	DYNAMIC POSTER STAND BIFACCIALE CON 4 PORTADEPLIANT A4, CORNICE CON ANGOLI VIVI E CON BASE QUADRATA IN AL D: 38 x 207 H cm	CGCAYD4012	130	€ 408,16	
 	BARRA DOUBLE CON PROFILO FORATO COMPLETA DI DUE TERMINALI IN AL L: 50 cm	CGACBP5001 CGACBP5003 CGACBP5005 CGACBP5006 CGACBP5007 CGACBP5009	132	€ 10,75	
	BARRA DOUBLE CON PROFILO FORATO COMPLETA DI DUE TERMINALI IN AL L: 100 cm	CGACBP0101 CGACBP0103 CGACBP0105 CGACBP0106 CGACBP0107 CGACBP0109	132	€ 21,50	
	BARRA DOUBLE CON PROFILO FORATO COMPLETA DI DUE TERMINALI IN AL L: 200 cm	CGACBP0201 CGACBP0203 CGACBP0205 CGACBP0206 CGACBP0207 CGACBP0209	132	€ 43,00	
	BARRA DOUBLE CON PROFILO FORATO COMPLETA DI DUE TERMINALI IN AL L: 300 cm	CGACBP0301 CGACBP0303 CGACBP0305 CGACBP0306 CGACBP0307 CGACBP0309	132	€ 64,50	

PREZZI RELATIVI AL COLORE  
BIANCO- ALTRI COLORI SP

# COMUNICAZIONE GLOBALE

IMMAGINE	DESCRIZIONE	CODICE E COLORE	PAG CAT	PREZZO	NOTE
  <p>PREZZI RELATIVI AL COLORE BIANCO- ALTRI COLORI SP</p>	BARRA DOUBLE CON RULLI COMPLETA DI DUE TERMINALI IN AL L: 50 cm	CGACBR5001 CGACBR5003 CGACBR5005 CGACBR5006 CGACBR5007 CGACBR5009	132	€ 11,00	
	BARRA DOUBLE CON RULLI COMPLETA DI DUE TERMINALI IN AL L: 100 cm	CGACBR0101 CGACBR0103 CGACBR0105 CGACBR0106 CGACBR0107 CGACBR0109	132	€ 22,00	
	BARRA DOUBLE CON RULLI COMPLETA DI DUE TERMINALI IN AL L: 200 cm	CGACBR0201 CGACBR0203 CGACBR0205 CGACBR0206 CGACBR0207 CGACBR0209	132	€ 44,00	
	BARRA DOUBLE CON RULLI COMPLETA DI DUE TERMINALI IN AL L: 300 cm	CGACBR0301 CGACBR0303 CGACBR0305 CGACBR0306 CGACBR0307 CGACBR0309	132	€ 66,00	
 <p>PREZZI RELATIVI AL COLORE BIANCO- ALTRI COLORI SP</p>	BARRA DOUBLE VUOTA SENZA TAPPI L: 50 cm	CGACBR0501 CGACBR0503 CGACBR0505 CGACBR0506 CGACBR0507 CGACBR0509	F CAT	€ 8,75	
	BARRA DOUBLE VUOTA SENZA TAPPI L: 100 cm	CGACBR1001 CGACBR1003 CGACBR1005 CGACBR1006 CGACBR1007 CGACBR1009	F CAT	€ 17,50	
	BARRA DOUBLE VUOTA SENZA TAPPI L: 200 cm	CGACBR2001 CGACBR2003 CGACBR2005 CGACBR2006 CGACBR2007 CGACBR2009	F CAT	€ 35,00	
	BARRA DOUBLE VUOTA SENZA TAPPI L: 300 cm	CGACBR3001 CGACBR3003 CGACBR3005 CGACBR3006 CGACBR3007 CGACBR3009	F CAT	€ 52,50	

# COMUNICAZIONE GLOBALE

IMMAGINE	DESCRIZIONE	CODICE E COLORE	PAG CAT	PREZZO	NOTE
	BASE TONDA IN FE	CPAACR3005	133	€ 48,12	
	BASE QUADRATA CON FORO CENTRALE IN FE	CPAASQ3005	133	€ 36,24	
	BASE QUADRATA CON FORO LATERALE IN FE	CPAAYQ3005	133	€ 36,24	
	SUPPORTO PER BASE IN ABS	CPAARL0101 CPAARL0105	134	€ 3,08	
	GIUNTO A T IN ABS	CPAART0101 CPAART0105	134	€ 5,59	
	GIUNTO A L IN ABS	CPAARB0101 CPAARB0105	134	€ 4,40	

# COMUNICAZIONE GLOBALE

IMMAGINE	DESCRIZIONE	CODICE E COLORE	PAG CAT	PREZZO	NOTE
	GIUNTO ANGOLARE A 3 VIE IN ABS	CPAARV0101 CPAARV0105	134	€ 14,25	
	GANCIO AD "S" IN FE D: 39 H mm Ø 3 mm	CPAAHM0112	134	€ 0,27	
	GANCIO PER CONTROSOFFITTO IN FE D: 32 x 29 mm	CPAAHS0312	134	€ 1,70	
	GANCIO PER BARRE DOUBLE IN STS	CPAAGB0112	134	€ 5,29	
	GANCIO A SOSPENSIONE PER BARRA IN FE	CGACBH0112	135	€ 1,08	

# COMUNICAZIONE GLOBALE

IMMAGINE	DESCRIZIONE	CODICE E COLORE	PAG CAT	PREZZO	NOTE
	GIUNTO LINEARE PER BARRA IN FE	CGACBH0212	135	€ 0,77	
	GIUNTO ANGOLARE PER BARRA IN FE	CGACBH0312	135	€ 0,90	
	GIUNTO A "T" PER BARRA IN FE	CGACBH0412	135	€ 0,90	
	TERMINALE PER BARRA DOUBLE IN PLASTICA	CGACBH0510	135	€ 0,47	
	GANCIO PER FISSAGGIO A PARETE BARRA DOUBLE IN FE	CGACBH0612	135	€ 7,14	



# COMUNICAZIONE GLOBALE

IMMAGINE	DESCRIZIONE	CODICE E COLORE	PAG CAT	PREZZO	NOTE
	GANCIO METALLICO PER SOSPENSIONE L: 15 cm	CPAA015012	135	€ 0,60	
	GANCIO METALLICO PER SOSPENSIONE L: 30 cm	CPAA030012	135	€ 0,73	
	GANCIO METALLICO PER SOSPENSIONE L: 50 cm	CPAA050012	135	€ 0,80	
	GANCIO METALLICO PER SOSPENSIONE L: 70 cm	CPAA070012	135	€ 0,87	
	GANCIO METALLICO PER SOSPENSIONE L: 100 cm	CPAA100012	135	€ 1,07	
	SET CAVI DI SOSPENSIONE REGOLABILE CON MOSCHETTONE IN ST	CPAAHHS112	135	€ 19,40	
	GANCIO AD S IN PLASTICA D: 36 H x $\varnothing$ 3 mm	CPAAHM0208	135	€ 7,00	CONF DA 50 PZ
	MORSETTO STRINGI CAVO D: 6,6 x 4,2 x 7 H mm	CPAAHHS113	135	€ 24,78	CONF DA 50 PZ

# COMUNICAZIONE GLOBALE

IMMAGINE	DESCRIZIONE	CODICE E COLORE	PAG CAT	PREZZO	NOTE
	BOBINA IN FILO D'ACCIAIO L: 50 Mt	CPAAHHS114	135	€ 96,34	

# ACCESSORI AREA VENDITA

IMMAGINE	DESCRIZIONE	CODICE E COLORE	PAG CAT	PREZZO	NOTE
	<p>MODULO ESPOSITIVO PIANO IN PLASTICA PER ORTOFRUTTA CON STAMPA EFFETTO LEGNO CON PIEDINI 4cm PORTATA MAX 150 Kg D: 81,5 x 61,5 x 84,5 H cm</p>	AVMEPOPL34	139	€ 342,89	
	<p>MODULO ESPOSITIVO PIANO IN PLASTICA PER ORTOFRUTTA CON STAMPA EFFETTO LEGNO CON RUOTE Ø 7,5 cm PORTATA MAX 150 Kg D: 81,5 x 61,5 x 84,5 H cm</p>	AVMEWHPL34	139	€ 393,72	
	<p>MODULO ESPOSITIVO INCLINATO IN PLASTICA PER ORTOFRUTTA CON STAMPA EFFETTO LEGNO CON PIEDINI 4cm PORTATA MAX 150 Kg D: 81,5 x 61,5 x 84,5 H cm</p>	AVME40PI34	139	€ 413,67	
	<p>MODULO ESPOSITIVO INCLINATO IN PLASTICA PER ORTOFRUTTA CON STAMPA EFFETTO LEGNO CON RUOTE Ø 7,5 cm PORTATA MAX 150 Kg D: 81,5 x 61,5 x 84,5 H cm</p>	AVMEWHPI34	139	€ 464,47	
	<p>MODULO ESPOSITIVO INCLINATO IN PLASTICA PER ORTOFRUTTA CON STAMPA EFFETTO LEGNO E PIANO SUPERIORE CON RUOTE Ø 7,5 cm PORTATA MAX 150 Kg PORTATA PIANO SUPERIORE: 20 Kg D: 81,5 x 61,5 x 84,5 H cm</p>	AVME1LCB34	139	€ 694,24	

# ACCESSORI AREA VENDITA

IMMAGINE	DESCRIZIONE	CODICE E COLORE	PAG CAT	PREZZO	NOTE
	<p>MODULO ESPOSITIVO COMBI INCLINATO IN PLASTICA CON STAMPA EFFETTO LEGNO E PIANO INFERIORE CON RUOTE Ø 7,5 cm</p> <p>PORTATA MAX 150 Kg</p> <p>D: 81,5 x 61,5 x 84,5 H cm</p>	AVCOMBIP34	140	€ 511,09	
	<p>MODULO ESPOSITIVO PIANO PER ORTOFRUTTA CON STAMPA EFFETTO LEGNO IN FOREX CON APERTURA MONOFACCIALE E PIEDINI 4 cm</p> <p>D: 81,5 x 61,5 x 84,5 cm</p>	AVMP40FX	140	SP	
	<p>MODULO ESPOSITIVO PIANO PER ORTOFRUTTA CON STAMPA EFFETTO LEGNO IN FOREX CON APERTURA MONOFACCIALE E RUOTE Ø 7,5 cm</p> <p>D: 81,5 x 61,5 x 84,5 cm</p>	AVMPWHFX	140	SP	
	<p>MODULO ESPOSITIVO PIANO PER ORTOFRUTTA CON STAMPA EFFETTO LEGNO IN FOREX CON APERTURA BIFACCIALE E PIEDINI 4 cm</p> <p>D: 81,5 x 61,5 x 84,5 cm</p>	AVMB40FX	140	SP	
	<p>MODULO ESPOSITIVO PIANO PER ORTOFRUTTA CON STAMPA EFFETTO LEGNO IN FOREX CON APERTURA BIFACCIALE E RUOTE Ø 7,5 cm</p> <p>D: 81,5 x 61,5 x 84,5 cm</p>	AVMBWHFX	140	SP	

\*ESCLUSO CONTENITORE PER ESPOSITORE

\*ESCLUSO CONTENITORE PER ESPOSITORE

# ACCESSORI AREA VENDITA

IMMAGINE	DESCRIZIONE	CODICE E COLORE	PAG CAT	PREZZO	NOTE
 <p>*ESCLUSO CONTENITORE PER ESPOSITORE</p>	MODULO ESPOSITIVO INCLINATO PER ORTOFRUTTA CON STAMPA EFFETTO LEGNO IN FOREX CON PIEDINI 4 cm D: 81,5 x 61,5 x 84,5 cm *STAMPA DIGITALE PERSONALIZZABILE	AVMI40FX	140	SP	
	MODULO ESPOSITIVO INCLINATO PER ORTOFRUTTA CON STAMPA EFFETTO LEGNO IN FOREX CON RUOTE Ø 7,5 cm D: 81,5 x 61,5 x 84,5 cm *STAMPA DIGITALE PERSONALIZZABILE	AVMIWHFX	140	SP	
	BASE CON RUOTE IN PS D: 80 x 60 H cm	AVMEBSWH05	141	€ 142,80	
	BASE CON PIEDINI IN PS D: 80 x 60 H cm	AVMEBSPI05	141	€ 89,94	

# ACCESSORI AREA VENDITA

IMMAGINE	DESCRIZIONE	CODICE E COLORE	PAG CAT	PREZZO	NOTE
	PARETE IN PS D: 81,5 x 61,5 x 84,5 H cm	AVMEPP86XX	141	€ 187,51	
	PARETE IN FOREX D: 81,5 x 61,5 x 84,5 H cm	AVMEPF86XX	141	SP	
	BASE SUPERIORE IN PS D: 80 x 60 H cm	AVMETF1105	141	€ 63,55	
	VASSOIO IN PS D: 80 x 60 x 7 H cm	AVMECT0705	141	€ 103,67	
	MENSOLA IN INOX 10/10 LUCIDO D: 80,4 x 43,8 cm	SEEPBS4005	141	€ 229,77	

# ACCESSORI AREA VENDITA





IMMAGINE	DESCRIZIONE	CODICE E COLORE	PAG CAT	PREZZO	NOTE
	SUPPORTO INCLINATO IN PS D: 81,5 x 61,5 x 4/20 H cm	AVMETS LT105	141	€ 85,00	
	CORNICE IN PLASTICA COMPLETA DI ASTA, ATTACCO A T STANDARD E TASCA ANTIRIFLESSO D: 21 x 29,7 cm	SEEPFRA401 SEEPFRA402 SEEPFRA403 SEEPFRA405 SEEPFRA406 SEEPFRA407	145	€ 10,00	
	PROFILO A L ANTISCIVOLO IN FOREX BASE PER SUPPORTO INCLINATO CON SPONDA D: 80 x 60 x 15 H cm	AVPFMI6005	145	€ 31,64	
	CONTENITORE PER ESPOSITORE IN FOREX D: 80 x 60 x 15 H cm	AVCTMI1505	145	€ 70,70	

# ACCESSORI AREA VENDITA

IMMAGINE	DESCRIZIONE	CODICE E COLORE	PAG CAT	PREZZO	NOTE
	PROFILO PORTAPREZZO PER CONTENITORI D: 80 x 4 H cm	CPPR048008	145	€ 3,33	
	SOLO STRUTTURA ROTOSELLER IN FE D: 60 x 55 x 135 H cm	SEEPRTC3	146	€ 626,04	
	STRUTTURA ROTOSELLER IN FE + 3 CESTI NERI IN PP D: 60 x 55 x 135 H cm	SEEPRTC305	146	€ 710,96	
	CESTO NERO CIRCOLARE IN PP D: 45 x 10 H cm	SEEPCT0105	146	€ 28,31	
	ESPOSITORE BAGUETTE D: 60 H cm 1 CESTO	AVMEBR0105	148	SP	
	ESPOSITORE BAGUETTE D: 60 H cm 2 CESTI	AVMEBR0205	148	SP	
	ESPOSITORE BAGUETTE D: 60 H cm 3 CESTI	AVMEBR0305	148	SP	



# ACCESSORI AREA VENDITA

IMMAGINE	DESCRIZIONE	CODICE E COLORE	PAG CAT	PREZZO	NOTE
	CESTO CIRCOLARE D: Ø 30x 38 cm	SECBBG3017	148	SP	
	SOSTEGNI PER CESTI ESPOSITORE BAGUETTE	SEKTPB06	148	SP	
	ASTA PER ESPOSITORE BAGUETTE D: 60 H cm	SEKTPB07	148	SP	
	CORNICE A4 CON ATTACCO A T IN ABS + PC D: 29,7 x 21 H cm	CPCRA40007	148	€ 7,83	
	SOLO STRUTTURA ESPOSITORE PANE PER 1 CESTO RETTANGOLARE D: 70 H cm	AVMEBS0105	149	€ 221,00	
	SOLO STRUTTURA ESPOSITORE PANE PER 2 CESTI RETTANGOLARI D: 70 H cm	AVMEBS0205	149	€ 278,00	
	SOLO STRUTTURA ESPOSITORE PANE PER 3 CESTI RETTANGOLARI D: 70 H cm	AVMEBS0305	149	€ 336,60	
	SOLO STRUTTURA ESPOSITORE PANE PER 3 CESTI RETTANGOLARI D: 70 H cm	AVMEBS0405	149	€ 394,40	

# ACCESSORI AREA VENDITA

IMMAGINE	DESCRIZIONE	CODICE E COLORE	PAG CAT	PREZZO	NOTE
	CESTO RETTANGOLARE D: 20 x 25 x 30 H cm	SECBBG3117	149	€ 30,00	
	SOSTEGNI PER CESTI RETTANGOLARI	AVMEKTBS05	149	SP	
	ASTA PER ESPOSITORE BAGUETTE D: 70 H cm	SEKTPB08	149	SP	
	CORNICE A4 CON ATTACCO A T IN ABS + PC D: 29,7 x 21 H cm	CPCRA40007	149	€ 7,83	
	SOLO STRUTTURA ESPOSITORE IN FERRO CON 2 CASSETTE IN LEGNO DOGATE D: 120 x 120 x 157 H cm	AVMECD0205	150	€ 476,00	
	SOLO STRUTTURA ESPOSITORE IN FERRO CON 4 CASSETTE IN LEGNO DOGATE D: 120 x 120 x 157 H cm	AVMECD0405	150	€ 578,00	
	SOLO STRUTTURA ESPOSITORE IN FERRO CON 6 CASSETTE IN LEGNO DOGATE D: 120 x 120 x 157 H cm	AVMECD0605	150	€ 680,00	
	SOLO STRUTTURA ESPOSITORE IN FERRO CON 8 CASSETTE IN LEGNO DOGATE D: 120 x 120 x 157 H cm	AVMECD0805	150	€ 782,00	

# ACCESSORI AREA VENDITA

IMMAGINE	DESCRIZIONE	CODICE E COLORE	PAG CAT	PREZZO	NOTE
	CASSETTA RETTANGOLARE IN LEGNO D: 40 x 30 x 15 H cm	SECTCS0834	150	€ 96,73	
	CASSETTA RETTANGOLARE IN LEGNO D: 40 x 30 x 10 H cm	SECTCS0734	150	€ 88,26	
	REGGI CASSETTA IN FERRO	AVMERGCD05	150	€ 51,00	
	PROFILO PORTAPREZZO PER CESTI L: 98,8 cm H 4 cm	CPPR032101	150	€ 4,84	
	CORNICE A4 CON ATTACCO A T IN ABS + PC D: 29,7 x 21 H cm	CPCRA40007	150	€ 7,83	
	ESPOSITORE A PIANI OTTOGONALI IN FERRO VERNICIATO D: 60 H cm Modulo espositivo per bottiglie di vino in ferro verniciato. Larghezza massima base: 60 cm Altezza: 156 cm Altezza spondine: 7 cm	AVMEOTWI05	151	€ 765,90	

# ACCESSORI AREA VENDITA

IMMAGINE	DESCRIZIONE	CODICE E COLORE	PAG CAT	PREZZO	NOTE
	SOLO STRUTTURA ESPOSITORE IN FERRO D: 150 H cm	AVMERHPF05	152	SP	
	ESPOSITORE PER ORTOFRUTTA IN FERRO + RIPIANI IN FOREX D: 150 H cm	AVMERHPP05	152	SP	
	ESPOSITORE PER ANANAS IN FERRO + FOREX + GANCI D: 150 H cm	AVMERHSP05	152	SP	
	GANCIO PER BANANE D: ø 5 mm L: 8 cm	AVGANB0805	152	SP	
	DISCO IN FOREX D: ø 35 cm	AVPFR35P05	152	SP	
	DISCO IN FOREX D: ø 45 cm	AVPFR45P06	152	SP	
	DISCO IN FOREX D: ø 50 cm	AVPFR50P07	152	SP	
	DISCO FORATO IN FOREX D: ø 35 cm	AVFFR35P05	152	SP	
	DISCO FORATO IN FOREX D: ø 45 cm	AVFFR45P06	152	SP	
	DISCO FORATO IN FOREX D: ø 50 cm	AVFFR50P07	152	SP	

# ACCESSORI AREA VENDITA

IMMAGINE	DESCRIZIONE	CODICE E COLORE	PAG CAT	PREZZO	NOTE
 <p>A black metal display stand with four wooden barrels arranged in a 2x2 grid. A red 'New' badge is in the top left corner.</p>	<p>ESPOSITORE A 4 BARILI 10 LT IN METALLO + PANNELLO IN FOREX PERSONALIZZABILE D: 60 x 46 x 150 H cm</p>	AVMEGA4PXX	153	€ 616,57	
 <p>Two images of display stands. The top one has two barrels stacked vertically. The bottom one has three barrels stacked vertically. A red 'New' badge is in the top left corner.</p>	<p>ESPOSITORE A 2 BARILI 20 LT IN METALLO + FOREX PERSONALIZZABILE D: 50 x 46 x 190 H cm</p>	AVMEGA2PXX	153	€ 432,29	
	<p>ESPOSITORE A 3 BARILI 20 LT IN METALLO + FOREX PERSONALIZZABILE D: 50 x 46 x 190 H cm</p>	AVMEGA3PXX	153	€ 528,50	
 <p>A single wooden barrel on a black metal stand with four legs. A red 'New' badge is in the top left corner.</p>	<p>ESPOSITORE IN FERRO PER BARILE 20 LT D: ø 38 x 56 H cm</p>	AVMEGTR005	153	€ 67,36	

\*BARILE ESCLUSO

# ACCESSORI AREA VENDITA

IMMAGINE	DESCRIZIONE	CODICE E COLORE	PAG CAT	PREZZO	NOTE
	CONTENITORE A BARILE 60 LT D: ø 32 x 55 H cm	AVMEGB6034	153	€ 134,30	
 <p>*COPERCHIO ESCLUSO</p>	INSERTO PER BARILE 42 LT D: ø 42 x 44 H cm	AVMEIN4408	153	€ 28,10	
	COPERCHIO PER INSERTO D: ø 40 x 20 H cm	AVMECO4008	153	€ 19,10	
	LOGO ADESIVO PERSONALIZZABILE	AVMEGAL0XX	153	SP	

# ACCESSORI AREA VENDITA

IMMAGINE	DESCRIZIONE	CODICE E COLORE	PAG CAT	PREZZO	NOTE
	BANCARELLA IN FILO RIPIEGABILE IN FE ALTEZZA CESTA INTERNA: 60 cm D: 40 x 60 x 80 cm	AVEPBR4612	154	SP	
	BANCARELLA IN FILO RIPIEGABILE IN FE ALTEZZA CESTA INTERNA: 60 cm D: 60 x 60 x 80 cm	AVEPBR6612	154	€ 164,50	
	BANCARELLA IN FILO RIPIEGABILE IN FE ALTEZZA CESTA INTERNA: 60 cm D: 60 x 80 x 80 cm	AVEPBR6812	154	€ 230,58	
	BANCARELLA IN FILO RIPIEGABILE IN FE ALTEZZA CESTA INTERNA: 60 cm D: 80 x 80 x 80 cm	AVEPBR8812	154	€ 233,45	
	BANCARELLA IN FILO RIGIDO A GAMBE QUADRE IN FE ALTEZZA CESTA INTERNA: 60 cm D: 80 x 80 x 80 cm	SEEPGF0812	154	€ 413,75	
	BANCARELLA IN FILO RIGIDO A GAMBE QUADRE IN FE ALTEZZA CESTA INTERNA: 60 cm D: 120 x 80 x 80 cm	SEEPGF1212	154	€ 437,70	
	AVANBANCO IN FILO D: 120 x 25 x 50 H cm ALTEZZA CESTA 20 cm	AVEPAV3012	154	€ 263,07	
	COPRI CESTA IN FILO PERSONALIZZABILE D: 80 x 60 x 80 H cm *PERSONALIZZABILE	AVPLXXXXXX	154	SP	

# ACCESSORI AREA VENDITA

IMMAGINE	DESCRIZIONE	CODICE E COLORE	PAG CAT	PREZZO	NOTE
	SALAMANDRA IN FERRO CON PIEDINI D: 40 x 195 H cm	AVSA40PD05	155	€ 192,50	
		AVSA40PD55	155	€ 192,50	
	SALAMANDRA IN FERRO CON PIEDINI D: 50 x 195 H cm	AVSA50PD05	155	€ 220,50	
		AVSA50PD55	155	€ 220,50	
	SALAMANDRA IN FERRO CON PIEDINI D: 60 x 195 H cm	AVSA60PD05	155	SP	
		AVSA60PD55	155	SP	
	SALAMANDRA IN FERRO CON BASE D: 40 x 195 H cm	AVSA40BA05	155	€ 192,50	
		AVSA40BA55	155	€ 192,50	
	SALAMANDRA IN FERRO CON BASE D: 50 x 195 H cm	AVSA50BA05	155	€ 220,50	
		AVSA50BA55	155	€ 220,50	
	SALAMANDRA IN FERRO CON BASE D: 60 x 195 H cm	AVSA60BA05	155	SP	
		AVSA60BA55	155	SP	
	GANCIO PER SALAMANDRA L: 20 cm	AVGASA2005 AVGASA2055	156	€ 5,00	
	GANCIO PER SALAMANDRA L: 30 cm	AVGASA3005 AVGASA3055	156	SP	
	GANCIO PER SALAMANDRA L: 40 cm	AVGASA4005 AVGASA4055	156	SP	



# ACCESSORI AREA VENDITA

IMMAGINE	DESCRIZIONE	CODICE E COLORE	PAG CAT	PREZZO	NOTE
	RIPIANO PER SALAMANDRA L: 40 cm	AVRIPA4005 AVRIPA4055	156	SP	
	RIPIANO PER SALAMANDRA L: 50 cm	AVRIPA5005 AVRIPA5055	156	€ 36,63	
	RIPIANO PER SALAMANDRA L: 60 cm	AVRIPA6005 AVRIPA6055	156	SP	
	ESPOSITORE PER OMBRELLI D: 40 x 35 x 162	AVMEPOMB05	156	€ 221,00	
	TAPPETO PERSONALIZZABILE IN GRAFICA E DIMENSIONI	AVACTPXXXX	156	SP	
	COPRI ANTENNE IN CARTONE PERSONALIZZABILI	AVCAHXXXXX	158	SP	

# ACCESSORI AREA VENDITA

IMMAGINE	DESCRIZIONE	CODICE E COLORE	PAG CAT	PREZZO	NOTE
	CONTORNO PALLET Componibile con apertura per carrelli elevatori D: 80 x 80 x 80 cm	AVCPH080XX	158	SP	
	CONTORNO PALLET Componibile con apertura per carrelli elevatori D: 120 x 80 x 80 cm	AVCPH180XX	158	SP	
	CONTORNO PALLET Componibile D: 120 x 80 x 150 cm	AVCPH115XX	158	SP	
	CONTORNO PALLET Componibile D: 80 x 80 x 150 cm	AVCPH215XX	158	SP	
	GLOBAL TROLLEY IN PP CAPACITÀ 64 LT IMPILABILE D: 48 x 45,5 x 86 cm *PERSONALIZZABILE CON ETICHETTA ADESIVA IN PVC	AVCS640102 AVCS640103 AVCS640106 AVCS640107 AVCS640109	160	€ 49,30	PERSONALIZZA ZIONE FRONTALE CON LOGO ADESIVO D: 25X10CM €3,40
	PORTA INFORMAZIONI PUBBLICITARIE PER GLOBAL TROLLEY D: 20,5 x 21,7 cm	AVSB640608	160	SP	
	TARGA DI INFORMAZIONE CON STAMPA SERIGRAFICA PER GLOBAL TROLLEY D: 10,7 x 3,8 cm	AVSB640510	160	SP	





# ACCESSORI AREA VENDITA

IMMAGINE	DESCRIZIONE	CODICE E COLORE	PAG CAT	PREZZO	NOTE
	CARRELLO MAXI TYKO IN PP CON 4 RUOTE (2 FISSE POSTERIORI E 2 PIROETTANTI ANTERIORI) CAPACITÀ 66 LT D: 53 x 50 x 94 cm *PERSONALIZZABILE CON ETICHETTA ADESIVA IN PVC	AVSBMXT702 AVSBMXT703 AVSBMXT705 AVSBMXT706 AVSBMXT707	161	€ 58,60	
	CESTO TYKO CON MANICO NERO IN PP CAPACITÀ 66 LT D: 54 x 36,5 x 28 cm *PERSONALIZZABILE CON ETICHETTA ADESIVA IN PVC	AVCSTY3302 AVCSTY3303 AVCSTY3305 AVCSTY3306 AVCSTY3307	161	€ 23,08	
	CESTO MINI TYKO CON MANICO NERO IN PP CAPACITÀ 22 LT D: 46,5 x 32,5 x 24 cm *PERSONALIZZABILE CON ETICHETTA ADESIVA IN PVC	AVCSMTY202 AVCSMTY203 AVCSMTY205 AVCSMTY206 AVCSMTY207	162	€ 14,50	
	CESTO 21 LT CON DOPPIO MANICO IMPILABILE IN PP PORTATA MAX: 25 Kg D: 51 x 35 x 20,7 cm *PERSONALIZZABILE CON ETICHETTA ADESIVA IN PVC	AVCS212102 AVCS212103 AVCS212105 AVCS212106 AVCS212107 AVCS212109	162	€ 10,32	
	CESTO 27 LT CON DOPPIO MANICO IMPILABILE IN PP PORTATA MAX: 25 Kg D: 51 x 35 x 27 cm *PERSONALIZZABILE CON ETICHETTA ADESIVA IN PVC	AVCS272102 AVCS272103 AVCS272105 AVCS272106 AVCS272107 AVCS272109	162	€ 14,15	



# ACCESSORI AREA VENDITA

IMMAGINE	DESCRIZIONE	CODICE E COLORE	PAG CAT	PREZZO	NOTE
	<p>CESTO 21 LT CON MANICO SINGOLO IMPILABILE IN PP            PORTATA MAX: 25 Kg            D: 51 x 35 x 20,7 cm            *PERSONALIZZABILE CON ETICHETTA ADESIVA IN PVC</p>	<p>AVCS210102            AVCS210103            AVCS210105            AVCS210106            AVCS210107            AVCS210109</p>	162	€ 8,66	
	<p>CESTO 27 LT CON MANICO SINGOLO IMPILABILE IN PP            PORTATA MAX: 25 Kg            D: 51 x 35 x 27 cm            *PERSONALIZZABILE CON ETICHETTA ADESIVA IN PVC</p>	<p>AVCS270102            AVCS270103            AVCS270105            AVCS270106            AVCS270107            AVCS270109</p>	162	€ 12,49	
	<p>CARRELLO PUPPY            Struttura impilabile C/3 ruote in plastica nera per cesti TYKO            D: 60 x 55 x 97 H cm</p>	AVCRBKDG12	163	€ 210,80	CESTI NON INCLUSI
	<p>CARRELLO SPESA SPEESY IN PP CON RUOTE E MANICO TELESCOPICO            CAPACITÀ 45 LT            *PERSONALIZZABILE CON ETICHETTA ADESIVA IN PVC</p>	<p>AVSBEY4502            AVSBEY4506</p>	163	€ 36,72	
		<p>AVSBEY4503            AVSBEY4507</p>	163	<p>€ 36,72 ≥100PZ            € 40,80 &lt;100PZ</p>	
	<p>CESTO PER PROFUMERIA            CAPACITÀ 12 LT</p>	<p>AVCSPF1201            AVCSPF1205</p>	CAT 2017	€ 21,80	



# ACCESSORI AREA VENDITA

IMMAGINE	DESCRIZIONE	CODICE E COLORE	PAG CAT	PREZZO	NOTE
	DISTRIBUTORE GUANTI E SACCHETTI INOX A BASE QUADRATA CON CARTELLO INFORMATIVO IN STS D: 45 x 120 cm	AVDSIX0112	165	€ 457,52	
	DISTRIBUTORE GUANTI E SACCHETTI A BASE QUADRATA SERIE ECO IN FE D: 40 x 125 cm	AVDSEC0107	165	€ 223,11	
	PORTA SACCHETTI IN FE PER CASSETTE D: 40 x 13 x 11 cm	AVDSCS0105 AVDSCS0107	165	€ 105,40	
	SPINGIPRODOTTO A MOLLA 6N-P: 28 cm	AVSP6N2808	168	€ 187,00	CF 20 PZ
	SPINGIPRODOTTO A MOLLA 6N-P: 38 cm	AVSP6N3808	168	€ 220,32	CF 20 PZ
	SPINGIPRODOTTO A MOLLA 6N-P: 48 cm	AVSP6N4808	168	SP	CF 20 PZ
	SPINGIPRODOTTO A MOLLA 9N-P: 38cm	AVSP9N3808	168	SP	CF 20 PZ
	SPINGIPRODOTTO A MOLLA 9N-P: 48cm	AVSP9N4808	168	SP	CF 20 PZ

# ACCESSORI AREA VENDITA

IMMAGINE	DESCRIZIONE	CODICE E COLORE	PAG CAT	PREZZO	NOTE
	BINARIO SEPARATORE PROFILO H 3 cm CON FERMO ADESIVO D: 100 x 2,5 x 3 H cm	AVSPF3B008	168	€ 62,40	CF 10 PZ
	BINARIO SEPARATORE PROFILO H 3 cm CON FERMO ADESIVO D: 124,5 x 2,5 x 3 H cm	AVSPF3B208	168	€ 63,80	CF 10 PZ
	BINARIO SEPARATORE PROFILO H 3 cm CON FERMO ADESIVO D: 132,5 x 2,5 x 3 H cm	AVSPF3B408	168	€ 68,00	CF 10 PZ
	BINARIO SEPARATORE PROFILO H 3 cm CON FERMO MAGNETICO D: 100 x 2,5 x 3 H cm	AVSPF3M008	168	€ 64,30	CF 10 PZ
	BINARIO SEPARATORE PROFILO H 3 cm CON FERMO MAGNETICO D: 124,5 x 2,5 x 3 H cm	AVSPF3M208	168	€ 80,00	CF 10 PZ
	BINARIO SEPARATORE PROFILO H 3 cm CON FERMO MAGNETICO D: 132,5 x 2,5 x 3 H cm	AVSPF3M408	168	€ 85,10	CF 10 PZ
	BINARIO SEPARATORE PROFILO H 6 cm CON FERMO ADESIVO D: 124,5 x 4 x 6 H cm	AVSPF6B208	168	€ 106,35	CF 10 PZ
	BINARIO SEPARATORE PROFILO H 6 cm CON FERMO ADESIVO D: 132,5 x 4 x 6 H cm	AVSPF6B408	168	€ 114,70	CF 10 PZ
	BINARIO SEPARATORE PROFILO H 6 cm CON FERMO MAGNETICO D: 100 x 4 x 6 H cm	AVSPF6M008	168	€ 94,80	CF 10 PZ
	BINARIO SEPARATORE PROFILO H 6 cm CON FERMO MAGNETICO D: 124,5 x 4 x 6 H cm	AVSPF6M208	168	€ 117,00	CF 10 PZ
	BINARIO SEPARATORE PROFILO H 6 cm CON FERMO MAGNETICO D: 132,5 x 4 x 6 H cm	AVSPF6M408	168	€ 133,20	CF 10 PZ

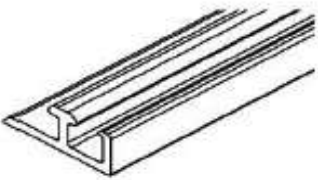
# ACCESSORI AREA VENDITA

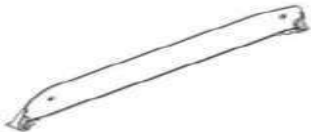

IMMAGINE	DESCRIZIONE	CODICE E COLORE	PAG CAT	PREZZO	NOTE
	BINARIO SEPARATORE PROFILO H 8 cm CON FERMO ADESIVO D: 124,5 x 6 x 8 H cm	AVSPF8B208	169	€ 170,20	CF 10 PZ
	BINARIO SEPARATORE PROFILO H 8 cm CON FERMO ADESIVO D: 132,5 x 6 x 8 H cm	AVSPF8B408	169	€ 171,10	CF 10 PZ
	BINARIO SEPARATORE PROFILO H 8 cm CON FERMO MAGNETICO D: 124,5 x 6 x 8 H cm	AVSPF8M208	169	€ 161,80	CF 10 PZ
	BINARIO SEPARATORE PROFILO H 8 cm CON FERMO MAGNETICO D: 132,5 x 6 x 8 H cm	AVSPF8M208	169	€ 185,00	CF 10 PZ
	GUIDA POSTERIORE ADESIVA D: 100 x 2,5 cm	AVSPB10008	169	€ 36,99	CF 10 PZ
	GUIDA POSTERIORE ADESIVA D: 124,5 x 2,5 cm	AVSPB12408	169	€ 31,44	CF 10 PZ
	GUIDA POSTERIORE ADESIVA D: 132,5 x 2,5 cm	AVSPB13208	169	€ 33,29	CF 10 PZ
	GUIDA POSTERIORE MAGNETICA D: 100 x 2,5 cm	AVSPM10008	169	€ 38,80	CF 10 PZ
	GUIDA POSTERIORE MAGNETICA D: 124,5 x 2,5 cm	AVSPM12408	169	€ 48,10	CF 10 PZ
	GUIDA POSTERIORE MAGNETICA D: 132,5 x 2,5 cm	AVSPM13208	169	€ 52,25	CF 10 PZ
	SEPARATORE SPEZZABILE OGNI 2,5 cm IN PC D: DA 18 A 38 cm x 3,5 H cm *UTILIZZABILE CON UN BINARIO ANTERIORE E POSTERIORE	AVSPSDW108	169	ND	CF 50 PZ

# ACCESSORI AREA VENDITA



IMMAGINE	DESCRIZIONE	CODICE E COLORE	PAG CAT	PREZZO	NOTE
	SEPARATORE SPEZZABILE OGNI 2,5 cm IN PC D: DA 18 A 38 cm x 5,5 H cm *UTILIZZABILE CON UN BINARIO ANTERIORE E POSTERIORE	AVSPSEW108	170	€ 127,62	CF 50 PZ
	SEPARATORE SPEZZABILE OGNI 2,5 cm IN PC D: DA 28 A 48 cm x 5,5 H cm *UTILIZZABILE CON UN BINARIO ANTERIORE E POSTERIORE	AVSPSFW108	170	€ 165,25	CF 50 PZ
	SEPARATORE SPEZZABILE OGNI 2,5 cm IN PC D: DA 38 A 58 cm x 5,5 H cm *UTILIZZABILE CON UN BINARIO ANTERIORE E POSTERIORE	AVSPSGW108	170	€ 208,08	CF 50 PZ
  *FISSABILE CON UN BINARIO ANTERIORE E POSTERIORE	SEPARATORE REVERSO SMALL IN PET D: 28 x 5,5 H cm	AVSPBF2808	170	€ 99,79	CF 50 PZ
	SEPARATORE REVERSO SMALL IN PET D: 33 x 5,5 H cm	AVSPBF3308	170	ND	CF 50 PZ
	SEPARATORE REVERSO SMALL IN PET D: 36 x 5,5 H cm	AVSPBF3608	170	€ 99,79	CF 50 PZ
	SEPARATORE REVERSO SMALL IN PET D: 38 x 5,5 H cm	AVSPBF3808	170	€ 110,98	CF 50 PZ
	SEPARATORE REVERSO SMALL IN PET D: 43 x 5,5 H cm	AVSPBF4308	170	€ 146,03	CF 50 PZ
	SEPARATORE REVERSO SMALL IN PET D: 46 x 5,5 H cm	AVSPBF4608	170	ND	CF 50 PZ
	SEPARATORE REVERSO SMALL IN PET D: 48 x 5,5 H cm	AVSPBF4808	170	€ 133,86	CF 50 PZ

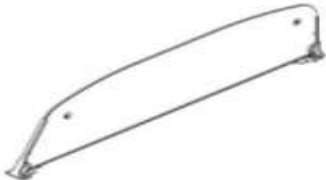

# ACCESSORI AREA VENDITA

IMMAGINE	DESCRIZIONE	CODICE E COLORE	PAG CAT	PREZZO	NOTE
 <p>*FISSABILE CON UN BINARIO ANTERIORE E POSTERIORE</p>	SEPARATORE REVERSO MEDIUM IN PET D: 28 x 10 H cm	AVSPCF2808	170	€ 127,16	CF 50 PZ
	SEPARATORE REVERSO MEDIUM IN PET D: 33 x 10 H cm	AVSPCF3308	170	€ 143,44	CF 50 PZ
	SEPARATORE REVERSO MEDIUM IN PET D: 36 x 10 H cm	AVSPCF3608	170	€ 150,28	CF 50 PZ
	SEPARATORE REVERSO MEDIUM IN PET D: 38 x 10 H cm	AVSPCF3808	170	€ 150,28	CF 50 PZ
	SEPARATORE REVERSO MEDIUM IN PET D: 43 x 10 H cm	AVSPCF4308	170	€ 168,78	CF 50 PZ
	SEPARATORE REVERSO MEDIUM IN PET D: 46 x 10 H cm	AVSPCF4608	170	€ 203,46	CF 50 PZ
	SEPARATORE REVERSO MEDIUM IN PET D: 48 x 10 H cm	AVSPCF4808	170	€ 163,07	CF 50 PZ
 <p>*FISSABILE CON UN BINARIO ANTERIORE E POSTERIORE</p>	SEPARATORE REVERSO XL IN PET D: 28 x 18 H cm	AVSPDF2808	171	€ 277,44	CF 50 PZ
	SEPARATORE REVERSO XL IN PET D: 33 x 18 H cm	AVSPDF3308	171	€ 335,24	CF 50 PZ
	SEPARATORE REVERSO XL IN PET D: 36 x 18 H cm	AVSPDF3608	171	ND	CF 50 PZ
	SEPARATORE REVERSO XL IN PET D: 38 x 18 H cm	AVSPDF3808	171	€ 311,44	CF 50 PZ
	SEPARATORE REVERSO XL IN PET D: 43 x 18 H cm	AVSPDF4308	171	€ 369,42	CF 50 PZ
	SEPARATORE REVERSO XL IN PET D: 46 x 18 H cm	AVSPDF4608	171	ND	CF 50 PZ
	SEPARATORE REVERSO XL IN PET D: 48 x 18 H cm	AVSPDF4808	171	€ 337,32	CF 50 PZ
	SEPARATORE REVERSO XL IN PET D: 53 x 18 H cm	AVSPDF5308	FC	€ 431,65	CF 50 PZ
	SEPARATORE REVERSO XL IN PET D: 58 x 18 H cm	AVSPDF5808	FC	€ 462,40	CF 50 PZ

# ACCESSORI AREA VENDITA

IMMAGINE	DESCRIZIONE	CODICE E COLORE	PAG CAT	PREZZO	NOTE
	ESTENSORE PER SPINGIPRODOTTO A MOLLA D: 9 x 11.5 H cm	AVSPEST115	171	€ 42,00	CF 20 PZ
 RICHIEDERE PREVENTIVO PER QUANTITÀ	SPINGIPRODOTTO SISTEMA TWIN CENTRALE DOPPIO 2N	AVSPTWC222	172	€ 14,76	
	SPINGIPRODOTTO SISTEMA TWIN CENTRALE DOPPIO 4N	AVSPTWC422	172	€ 15,06	
	SPINGIPRODOTTO SISTEMA TWIN CENTRALE DOPPIO 6N	AVSPTWC622	172	€ 15,37	
	SPINGIPRODOTTO SISTEMA TWIN CENTRALE DOPPIO 10N	AVSPTWC102	172	€ 15,99	
	SPINGIPRODOTTO SISTEMA TWIN CENTRALE DOPPIO 14N	AVSPTWC142	172	€ 16,62	
 RICHIEDERE PREVENTIVO PER QUANTITÀ	SPINGIPRODOTTO SISTEMA TWIN DESTRO 2N	AVSPTWR222	173	€ 12,18	
	SPINGIPRODOTTO SISTEMA TWIN DESTRO 4N	AVSPTWR422	173	€ 12,48	
	SPINGIPRODOTTO SISTEMA TWIN DESTRO 6N	AVSPTWR622	173	€ 12,68	
	SPINGIPRODOTTO SISTEMA TWIN DESTRO 10N	AVSPTWR102	173	€ 13,18	
	SPINGIPRODOTTO SISTEMA TWIN DESTRO 14N	AVSPTWR142	173	€ 13,72	
 RICHIEDERE PREVENTIVO PER QUANTITÀ	SPINGIPRODOTTO SISTEMA TWIN SINISTRO 2N	AVSPTWL222	173	€ 12,18	
	SPINGIPRODOTTO SISTEMA TWIN SINISTRO 4N	AVSPTWL422	173	€ 12,48	
	SPINGIPRODOTTO SISTEMA TWIN SINISTRO 6N	AVSPTWL622	173	€ 12,68	
	SPINGIPRODOTTO SISTEMA TWIN SINISTRO 10N	AVSPTWL102	173	€ 13,18	
	SPINGIPRODOTTO SISTEMA TWIN SINISTRO 14N	AVSPTWL142	173	€ 13,72	

# ACCESSORI AREA VENDITA

IMMAGINE	DESCRIZIONE	CODICE E COLORE	PAG CAT	PREZZO	NOTE
	GUIDA ANTERIORE ADESIVA DOPPIA D: 4 x 100 cm	AVSPTWGA22	173	€ 6,12	
	GUIDA ANTERIORE MAGNETICA DOPPIA D: 4 x 100 cm	AVSPTWGM22	173	SP	
	SISTEMA DI AGGANCIO PER GUIDA POSTERIORE	AVSPTWGP22	173	€ 0,77	
	PIATTINA ACCESSORIA SISTEMA TWIN	AVSPTWPI22	173	€ 1,30	
	SPINGIPRODOTTO CENTRALE A MOLLA PER TAVOLETTE DI CIOCCOLATO IN PC P: 9 N	AVSPMC9N08	174	€ 31,42	
	SPINGIPRODOTTO SINISTRO A MOLLA PER TAVOLETTE DI CIOCCOLATO IN PC P: 9 N	AVSPML9N08	174	€ 42,95	
	SPINGIPRODOTTO DESTRO A MOLLA PER TAVOLETTE DI CIOCCOLATO IN PC P: 9 N	AVSPML9N08	174	€ 42,95	



# ACCESSORI AREA VENDITA

IMMAGINE	DESCRIZIONE	CODICE E COLORE	PAG CAT	PREZZO	NOTE
	TAGLIERE DA BANCO CON FERMI IN PE D: 40 x 30 x 2 H cm	AVAVCB02001	176	€ 57,77	
	TAGLIERE DA BANCO CON FERMI IN PE D: 50 x 40 x 2 H cm	AVAVCB12001	176	€ 92,43	
	TAGLIERE DA BANCO CON FERMI IN PE D: 60 x 40 x 2 H cm	AVAVCB22001	176	€ 109,98	
	TAGLIERE DA BANCO CON FERMI IN PE D: 70 x 40 x 2 H cm	AVAVCB32001	176	€ 127,55	
	TAGLIERE DA BANCO CON FERMI IN PE D: 80 x 40 x 2 H cm	AVAVCB42001	176	€ 145,11	
	TAGLIERE DA BANCO CON FERMI IN PE D: 40 x 30 x 2,5 H cm	AVAVCB02501	176	€ 74,41	
	TAGLIERE DA BANCO CON FERMI IN PE D: 50 x 40 x 2,5 H cm	AVAVCB12501	176	€ 120,63	
	TAGLIERE DA BANCO CON FERMI IN PE D: 60 x 40 x 2,5 H cm	AVAVCB22501	176	€ 143,96	
	TAGLIERE DA BANCO CON FERMI IN PE D: 70 x 40 x 2,5 H cm	AVAVCB32501	176	€ 167,07	
	TAGLIERE DA BANCO CON FERMI IN PE D: 80 x 40 x 2,5 H cm	AVAVCB42501	176	€ 187,86	
	TAGLIERE DA BANCO CON FERMI IN PE D: 40 x 30 x 3 H cm	AVAVCB03001	176	€ 88,50	
	TAGLIERE DA BANCO CON FERMI IN PE D: 50 x 40 x 3 H cm	AVAVCB13001	176	€ 143,96	
	TAGLIERE DA BANCO CON FERMI IN PE D: 60 x 40 x 3 H cm	AVAVCB23001	176	€ 171,69	
	TAGLIERE DA BANCO CON FERMI IN PE D: 70 x 40 x 3 H cm	AVAVCB33001	176	€ 199,41	
	TAGLIERE DA BANCO CON FERMI IN PE D: 80 x 40 x 3 H cm	AVAVCB43001	176	€ 227,37	

# ACCESSORI AREA VENDITA

IMMAGINE	DESCRIZIONE	CODICE E COLORE	PAG CAT	PREZZO	NOTE
	FILMATRICE MANUALE IN STS D: 50 x 61 x 13,5 cm L MAX ROTOLO: 40 cm	AVAVHW4031	176	ND	
	FILMATRICE MANUALE IN STS D: 55 x 61 x 13,5 cm L MAX ROTOLO: 45 cm	AVAVHW4531	176	€ 516,00	
	FILMATRICE MANUALE IN STS D: 55 x 61 x 13,5 cm L MAX ROTOLO: 50 cm	AVAVHW5031	FC	€ 566,10	
	MACCHINA TAGLIA FORMAGGIO	AVAVTFMA31	176	€ 578,00	
	STERILIZZATRICE PER COLTELLI L: 23 cm	AVAVSC0031	176	€ 716,04	
	BATTICARNE IN STS PESO: 1,5 Kg	AVAVMT1531	177	€ 62,60	
	BATTICARNE IN STS PESO: 2 Kg	AVAVMT2031	177	€ 77,33	
	SPAZZOLA PULISCI FORNO L: 110 cm	AVAFSP0108	177	€ 99,90	

# ACCESSORI AREA VENDITA

IMMAGINE	DESCRIZIONE	CODICE E COLORE	PAG CAT	PREZZO	NOTE
	GUANTO IN MAGLIA IN STS TAGLIA: XS (VERDE)	AVAVGSXS31	177	€ 196,63	
	GUANTO IN MAGLIA IN STS TAGLIA: S (BIANCO)	AVAVGSOS31	177	€ 196,63	
	GUANTO IN MAGLIA IN STS TAGLIA: M (ROSSO)	AVAVGSOM31	177	€ 196,63	
	GUANTO IN MAGLIA IN STS TAGLIA: L (BLU)	AVAVGSOL31	177	€ 196,63	
	GUANTO IN MAGLIA IN STS TAGLIA: XL (ARANCIONE)	AVAVGSXL31	177	€ 196,63	
	GUANTO IN MAGLIA CON MANICOTTO IN STS TAGLIA: XS (VERDE)	AVAVGLXS31	177	€ 348,82	
	GUANTO IN MAGLIA CON MANICOTTO IN STS TAGLIA: S (BIANCO)	AVAVGL0S31	177	€ 348,82	
	GUANTO IN MAGLIA CON MANICOTTO IN STS TAGLIA: M (ROSSO)	AVAVGL0M31	177	€ 348,82	
	GUANTO IN MAGLIA CON MANICOTTO IN STS TAGLIA: L (BLU)	AVAVGL0L31	177	€ 348,82	
	GUANTO IN MAGLIA CON MANICOTTO IN STS TAGLIA: XL (ARANCIONE)	AVAVGLXL31	177	€ 348,82	

# ACCESSORI AREA VENDITA

IMMAGINE	DESCRIZIONE	CODICE E COLORE	PAG CAT	PREZZO	NOTE
	TRINCIAPOLLO IN STS L: 25 cm	AVAVPS0031	177	€ 54,18	
	MOLLA DI RICAMBIO PER TRINCIAPOLLO IN STS	AVAVPS0032/MOL	FC	€ 3,44	
	BARRA MAGNETICA APPENDI COLTELLI L: 50 cm	AVBACM5012	177	€ 30,42	
	FORBICI IN STS L: 23 cm	AVAVSC0031	177	€ 27,16	
	ROTELLA PIZZA D: Ø 10 cm	AVRP050617	177	€ 17,45	
	APRISCATOLE	AVASTT3360	177	€ 48,54	
	PINZA PER TEGLIE INOX L: 25 cm	AVAVPT2531	178	€ 29,74	

# ACCESSORI AREA VENDITA





IMMAGINE	DESCRIZIONE	CODICE E COLORE	PAG CAT	PREZZO	NOTE
	PALA PIZZA IN LEGA DI ALLUMINIO L: 135 cm ø: 5 mm	AVAVPP0135	178	€ 153,55	*FORATA
	PALA PIZZA IN LEGA DI ALLUMINIO L: 170 cm	AVAVPP0170	178	€ 139,90	
	BOBINA PER MACCHINA TAGLIA FORMAGGIO L: 14 Mt	AVAVTFB031	178	€ 10,60	
	COLTELLO GRANA PAVIA LAMA: 12 cm	AVAVCP0135	178	€ 26,86	
	ALZA FORMAGGIO INOX	AVAVLZF31	178	€ 340,00	
	BARRA "CLIENTE SUCCESSIVO" BIANCA CON SCRITTA ROSSA L: 25 cm	AVAVBCS101	179	€ 3,70	
	BARRA "CLIENTE SUCCESSIVO" NERA CON SCRITTA BIANCA L: 25 cm	AVAVBCS105	179	€ 3,70	
	BARRA "CASSA CHIUSA" L: 23 cm	AVAVBCC105	179	€ 3,70	
 *CARTONCINO ESCLUSO	BARRA PERSONALIZZABILE CON APERTURA SUPERIORE L: 25 cm	AVAVBP0108	179	€ 12,99	



# ACCESSORI AREA VENDITA

IMMAGINE	DESCRIZIONE	CODICE E COLORE	PAG CAT	PREZZO	NOTE
	RENDIRESTO PERSONALIZZABILE D: 15 x 15 cm	AVAVRR08XX	179	€ 16,77	
	JOKER PORTA CESTO UNIVERSALE IN FE CON RUOTE PIROETTANTI E STRUTTURA IN METALLO REGOLABILE PORTATA MAX: 65 Kg D MAX 49 x 36 cm D MIN: 40 x 27 cm	AVCSJR0112	181	€ 170,30	
	CARRELLO PORTACASSETTE CON RUOTE PIROETTANTI D: 60 x 40 cm	SEPPN0206	181	€ 87,72	
	CARRELLO PORTACASSETTE IN FILO METALLICO D: 60 x 40 cm	SEPPN0112	181	€ 233,92	
	PIANETTA 4 RUOTE CON MANICO D: 80 x 46 x 95,5 H cm	AVLPI4RS12	181	€ 486,71	
	PIANETTA 4 RUOTE CON RIBALTA D: 80 x 46 x 95,5 H cm L. ribalta: 69,5cm	AVLPI4RR12	182	€ 661,23	



# ACCESSORI AREA VENDITA

IMMAGINE	DESCRIZIONE	CODICE E COLORE	PAG CAT	PREZZO	NOTE
	PIANETTA 6 RUOTE CON MANICO D: 130 x 46 x 95,5 H cm	AVLPI6RS12	182	€ 589,22	
	PIANETTA 6 RUOTE CON RIBALTA D: 130 x 46 x 95,5 H cm L. ribalta: 69,5cm	AVLPI6RR12	182	€ 787,50	
	ROLL CONTAINER CON 3 PARETI D: 71,5 x 80,5 x 160 H cm	AVLRC16012	183	€ 385,00	
	SCALA IN ALLUMINIO 3 GRADINI	AVS8211133	183	€ 79,10	
	SCALA IN ALLUMINIO 4 GRADINI	AVS8211134	183	€ 93,48	

# ACCESSORI AREA VENDITA

IMMAGINE	DESCRIZIONE	CODICE E COLORE	PAG CAT	PREZZO	NOTE
	SCALA IN ALLUMINIO 6 GRADINI	AVS8211138	183	€ 123,01	
	SIGILLA SACCHETTI CON LAMA DI RIFILO L: 25 cm	AVDSSB0102	CAT 20	€ 20,80	
	ROTOLE PER SIGILLA SACCHETTI L: 0,9 cm	AVDSRSB103 AVDSRSB106 AVDSRSB107 AVDSRSB102	CAT 20	€ 32,75	CONF DA 24 RT
	ROTOLE PER SIGILLA SACCHETTI L: 0,9 cm	AVDSRSB203 AVDSRSB206 AVDSRSB207 AVDSRSB202	CAT 2017	€ 214,20	CONF DA 192 RT

# EXPOWORLD

IMMAGINE	DESCRIZIONE	CODICE E COLORE	PAG CAT	PREZZO	NOTE
	BASE BOARD D: 30 x 30 x 10 cm	B8300	190	SP	
	BASE BOARD D: 50 x 35 x 10 cm	B8500	190	SP	
	BASE BOARD D: 60 x 35 x 10 cm	B8600	190	SP	
	BASE BOARD D: 80 x 35 x 10 cm	B8800	190	SP	
	BASE BOARD D: 100 x 35 x 10 cm	B81000	190	SP	
	BASE PINCHER D: 30 x 40,5 cm	BP300	190	SP	
	BASE PINCHER D: 40 x 50 cm	BP400	190	SP	
	TOTEM COMUNICAZIONE D: 60 x 200 cm PIEDINI IN PIUMA Ø 20 mm PANNELLO IN PIUMA Ø 20 mm	PIUMA60X200	191	SP	
	TOTEM COMUNICAZIONE D: 75 x 200 cm PIEDINI IN PIUMA Ø 20 mm PANNELLO IN PIUMA Ø 20 mm	PIUMA75X200	191	SP	
	TOTEM COMUNICAZIONE D: 100 x 200 cm PIEDINI IN PIUMA Ø 20 mm PANNELLO IN PIUMA Ø 20 mm	PIUMA100X200	191	SP	
	TOTEM COMUNICAZIONE D: 100 x 250 cm PIEDINI IN PIUMA Ø 20 mm PANNELLO IN PIUMA Ø 20 mm	PIUMA100X250	191	SP	
	TOTEM COMUNICAZIONE D: 100 x 300 cm PIEDINI IN PIUMA Ø 20 mm PANNELLO IN PIUMA Ø 20 mm	PIUMA100X300	191	SP	

# EXPOWORLD

IMMAGINE	DESCRIZIONE	CODICE E COLORE	PAG CAT	PREZZO	NOTE
	TOTEM KARTON D: 60 x 200 cm IN CARTONE	KARTON1960X200	191	SP	
	TOTEM KARTON D: 75 x 200 cm IN CARTONE	KARTON1975X200	191	SP	
	TOTEM KARTON D: 100 x 200 cm IN CARTONE	KARTON19100X200	191	SP	
	TOTEM KARTON D: 100 x 250 cm IN CARTONE	KARTON19100X250	191	SP	
	TOTEM KARTON D: 100 x 300 cm IN CARTONE	KARTON19100X300	191	SP	
 <p>Piedini Plex 10 mm</p>	TOTEM COMUNICAZIONE GRANDE CON PIEDINI IN PLEXIGLASS 10 MM D: 10 x 20 cm	PLEXIBIG100X200	191	SP	
	TOTEM COMUNICAZIONE GRANDE CON PIEDINI IN PLEXIGLASS 10 MM D: 12 x 25 cm	PLEXIBIG120X250	191	SP	
	TOTEM COMUNICAZIONE GRANDE CON PIEDINI IN PLEXIGLASS 10 MM D: 10 x 30 cm	PLEXIBIG100X300	191	SP	
	TOTEM COMUNICAZIONE GRANDE CON PIEDINI IN PLEXIGLASS 10 MM D: 15 x 30 cm	PLEXIBIG150X300	191	SP	
 <p>Piedini Forex 10 mm</p>	TOTEM COMUNICAZIONE GRANDE CON PIEDINI IN FOREX 10 MM D: 10 x 20 cm	FOREXBIG100X200	191	SP	
	TOTEM COMUNICAZIONE GRANDE CON PIEDINI IN FOREX 10 MM D: 12 x 25 cm	FOREXBIG120X250	191	SP	
	TOTEM COMUNICAZIONE GRANDE CON PIEDINI IN FOREX 10 MM D: 10 x 30 cm	FOREXBIG100X300	191	SP	
	TOTEM COMUNICAZIONE GRANDE CON PIEDINI IN FOREX 10 MM D: 15 x 30 cm	FOREXBIG150X300	191	SP	





# EXPOWORLD

IMMAGINE	DESCRIZIONE	CODICE E COLORE	PAG CAT	PREZZO	NOTE
 <p>Piedini Dibond 3 mm</p>	<p>TOTEM COMUNICAZIONE GRANDE CON PIEDINI IN DIBOND 10 MM D: 10 x 20 cm</p>	DIBONDBIG100X2 00	191	SP	
	<p>TOTEM COMUNICAZIONE GRANDE CON PIEDINI IN DIBOND 10 MM D: 12 x 25 cm</p>	DIBONDBIG120X2 50	191	SP	
	<p>TOTEM COMUNICAZIONE GRANDE CON PIEDINI IN DIBOND 10 MM D: 10 x 30 cm</p>	DIBONDBIG100X3 00	191	SP	
	<p>TOTEM COMUNICAZIONE GRANDE CON PIEDINI IN DIBOND 10 MM D: 15 x 30 cm</p>	DIBONDBIG150X3 00	191	SP	
	<p>TOTEM GANZ D: 65,4 x 33,7 x 170,2 H cm</p> <ul style="list-style-type: none"> <li>• Totem bifacciale struttura in alluminio</li> <li>• Illuminazione con lampade interne da 2 x 58 Watt</li> </ul>	CGCATG02	192	SP	
	<p>FORMULATE MONOLITE D: 230 x 65 x 25 cm</p>	FMSSVSS01	192	SP	
	<p>FORMULATE MONOLITE D: 230 x 95,5 x 25 cm</p>	FMSSVSS02	192	SP	
	<p>FORMULATE MONOLITE D: 230 x 124 x 25 cm</p>	FMSSVSS03	192	SP	
	<p>FORMULATE MONOLITE D: 230 x 154,4 x 25 cm</p>	FMSSVSS04	192	SP	

# EXPOWORLD

IMMAGINE	DESCRIZIONE	CODICE E COLORE	PAG CAT	PREZZO	NOTE
	TOTEM MODULARE IN CARTONE MICROCANALE D: 30 x 30 H cm *PERSONALIZZABILE	AVCB3030XX	193	SP	
	TOTEM MODULARE IN CARTONE MICROCANALE D: 45 x 45 H cm *PERSONALIZZABILE	AVCB4545XX	193	SP	
	CORNICE PROMOZIONALE ESTENSIBILE "OFFERTA" IN FOREX 5 mm D: L 80 x H 50-80 cm	AVCS5080XX	193	SP	
	CORNICE PROMOZIONALE ESTENSIBILE IN FOREX 5 mm D: L e H 53-80 cm	AVCD5380XX	193	SP	
	GATE XL TOTEM IN PP D: 290 x 255 H cm *PERSONALIZZABILE	AVBGOXLPLL	194	SP	

# EXPOWORLD

IMMAGINE	DESCRIZIONE	CODICE E COLORE	PAG CAT	PREZZO	NOTE
	<p>GATE XXL TOTEM IN PP D: 370 x 297 H cm *PERSONALIZZABILE</p>	AVBGOXXLPPL	194	SP	
	<p>SAGOMA "PIZZA" IN PIUMA PER INTERNO D: 170 x 80 cm</p>	FMSSVSSXX	195	SP	
	<p>SAGOMA "FAST FOOD" IN PIUMA PER INTERNO D: 170 x 80 cm</p>	FMSSVSSXX	195	SP	
	<p>SAGOMA "BURGER MENU" IN PIUMA PER INTERNO D: 170 x 80 cm</p>	FMSSVSSXX	195	SP	
	<p>SAGOMA "FAST FOOD" IN PIUMA PER INTERNO D: 170 x 80 cm</p>	FMSSVSSXX	195	SP	



# EXPOWORLD

IMMAGINE	DESCRIZIONE	CODICE E COLORE	PAG CAT	PREZZO	NOTE
	TOTEM BEER#1 IN PIUMA PER ESTERNO D: 60 x 180 cm	FMSSVSSXX	196	SP	
	TOTEM BEER#2 IN PIUMA PER ESTERNO D: 60 x 180 cm	FMSSVSSXX	196	SP	
	TOTEM BEER#3 IN PIUMA PER ESTERNO D: 60 x 180 cm	FMSSVSSXX	196	SP	
	TOTEM BEER#4 IN PIUMA PER INTERNO D: 80 x 100 cm	FMSSVSSXX	196	SP	
	TOTEM BEER#5 IN PIUMA PER INTERNO D: 80 x 170 cm	FMSSVSSXX	196	SP	

# EXPOWORLD

IMMAGINE	DESCRIZIONE	CODICE E COLORE	PAG CAT	PREZZO	NOTE
	TOTEM ICECREAM#1 IN PIUMA PER INTERNO D: 87 x 170 cm	FMSSVSSXX	197	SP	
	TOTEM ICECREAM#2 IN PIUMA PER INTERNO D: 67 x 160 cm	FMSSVSSXX	197	SP	
	TOTEM ICECREAM#3 IN PIUMA PER INTERNO D: 100 x 120 cm	FMSSVSSXX	197	SP	
	TOTEM ICECREAM#4 IN PIUMA PER INTERNO D: 100 x 120 cm	FMSSVSSXX	197	SP	
	TOTEM ORANGEDRINK#1 IN PIUMA PER INTERNO D: 73 x 170 cm	FMSSVSSXX	197	SP	

# EXPOWORLD

IMMAGINE	DESCRIZIONE	CODICE E COLORE	PAG CAT	PREZZO	NOTE
	TOTEM ORANGEDRINK#2 IN PIUMA PER INTERNO D: 73 x 170 cm	FMSSVSSXX	197	SP	
	TOTEM COFFE IN PIUMA PER INTERNO D: 56 x 170 cm	FMSSVSSXX	197	SP	
	TOTEM COFFEE IN PIUMA PER INTERNO D: 90 x 100 cm	FMSSVSSXX	197	SP	
	TOTEM NOJITO IN PIUMA PER INTERNO D: 90 x 120 cm	FMSSVSSXX	197	SP	
	TOTEM DRINK IN PIUMA PER INTERNO D: 90 x 170 cm	FMSSVSSXX	197	SP	

# EXPOWORLD

IMMAGINE	DESCRIZIONE	CODICE E COLORE	PAG CAT	PREZZO	NOTE
	<p>MOSQUITO D: 210 x 66 x 28,5 cm PROFILO SUPERIORE CON SISTEMA A SCATTO PIEDINI STABILIZZATI COMPLETO DI BORSA PER IL TRASPORTO</p>	UB197600	198	SP	
	<p>MOSQUITO D: 210 x 80 x 28,5 cm PROFILO SUPERIORE CON SISTEMA A SCATTO PIEDINI STABILIZZATI COMPLETO DI BORSA PER IL TRASPORTO</p>	UB197	198	SP	
	<p>MOSQUITO D: 210 x 85 x 28,5 cm PROFILO SUPERIORE CON SISTEMA A SCATTO PIEDINI STABILIZZATI COMPLETO DI BORSA PER IL TRASPORTO</p>	UB196	198	SP	
	<p>MOSQUITO D: 210 x 1000 x 28,5 cm PROFILO SUPERIORE CON SISTEMA A SCATTO PIEDINI STABILIZZATI COMPLETO DI BORSA PER IL TRASPORTO</p>	UB1971000	198	SP	
	<p>MOSQUITO D: 210 x 1200 x 28,5 cm PROFILO SUPERIORE CON SISTEMA A SCATTO PIEDINI STABILIZZATI COMPLETO DI BORSA PER IL TRASPORTO</p>	UB1971200	198	SP	
	<p>MOSQUITO D: 210 x 1500 x 28,5 cm PROFILO SUPERIORE CON SISTEMA A SCATTO PIEDINI STABILIZZATI COMPLETO DI BORSA PER IL TRASPORTO</p>	UBI1971500	198	SP	
	<p>MOSQUITO D: 210 x 200 x 28,5 cm PROFILO SUPERIORE CON SISTEMA A SCATTO PIEDINI STABILIZZATI COMPLETO DI BORSA PER IL TRASPORTO</p>	UBI1972000	198	SP	

# EXPOWORLD

IMMAGINE	DESCRIZIONE	CODICE E COLORE	PAG CAT	PREZZO	NOTE
	ESPOSITORE PER SMARTPHONE IN PLEXIGLASS SPESSORE 3 mm *PERSONALIZZABILE	PWESPL1808	202	SP	1 PZ
	ESPOSITORE COSMETICA IN PLEXIGLASS SPESSORE 3 mm *PERSONALIZZABILE	PWESPL0808	202	SP	1 PZ
	ESPOSITORE IN PLEXIGLASS SPESSORE 3 mm *PERSONALIZZABILE	PWESPL0908	202	SP	1 PZ
	ESPOSITORE IN PLEXIGLASS SPESSORE 3 mm *PERSONALIZZABILE	PWESPL1008	202	SP	1 PZ
	ESPOSITORE PER PROFUMERIA IN PLEXIGLASS SPESSORE 3 mm *PERSONALIZZABILE	PWESPL1108	203	SP	1 PZ
	ESPOSITORE IN PLEXIGLASS SPESSORE 3 mm *PERSONALIZZABILE	PWESPL1208	203	SP	1 PZ
	ESPOSITORE IN PLEXIGLASS SPESSORE 3 mm *PERSONALIZZABILE	PWESPL1308	203	SP	1 PZ

# EXPOWORLD

IMMAGINE	DESCRIZIONE	CODICE E COLORE	PAG CAT	PREZZO	NOTE
	ESPOSITORE IN PLEXIGLASS SPESSORE 3 mm *PERSONALIZZABILE	PWESPL1408	203	SP	1 PZ
	PORTA BROCHURE IN PLEXIGLASS SPESSORE 3 mm *PERSONALIZZABILE	PWESPL1508	204	SP	1 PZ
	ESPOSITORE BOTTIGLIE IN PLEXIGLASS SPESSORE 3 mm *PERSONALIZZABILE	PWESPL1608	204	SP	1 PZ
	CONTENITORE A CUPOLA IN PLEXIGLASS SPESSORE 3 mm *PERSONALIZZABILE	PWESPL1908	204	SP	1 PZ
	CONTENITORE OVALE IN PLEXIGLASS SPESSORE 3 mm *PERSONALIZZABILE	PWESPL2008	204	SP	1 PZ
	PORTA BOTTIGLIE 6 FORI IN PLEXIGLASS SPESSORE 6 mm D: 13,5 x 50 cm *PERSONALIZZABILE	PWENPL0599	205	SP	1 PZ
	PORTA BOTTIGLIE 6 FORI IN PLEXIGLASS SPESSORE 6 mm D: 10 x 70 cm *PERSONALIZZABILE	PWENPL0699	205	SP	1 PZ

# EXPOWORLD



IMMAGINE	DESCRIZIONE	CODICE E COLORE	PAG CAT	PREZZO	NOTE
	PORTA BOTTIGLIE 12 FORI IN PLEXIGLASS SPESSORE 6 mm *PERSONALIZZABILE	PWENPL0799	205	SP	1 PZ
	PORTA BOTTIGLIE E BICCHIERI IN PLEXIGLASS SPESSORE 5 mm D: 30 x 12 x 25 cm *PERSONALIZZABILE	PWENPL0899	205	SP	1 PZ
	PORTA BOTTIGLIE A MURO IN PLEXIGLASS SPESSORE 6 mm D: 10 x 8 cm *PERSONALIZZABILE	PWENPL0999	206	SP	1 PZ
	PORTA BOTTIGLIE IN FOREX SPESSORE 20 mm *PERSONALIZZABILE	PWENPL1099	206	SP	1 PZ
	PORTA CONI IN PLEXIGLASS SPESSORE 5 mm *PERSONALIZZABILE	PWPGPL0199	206	SP	1 PZ
	TAGLIERE CONI IN PLEXIGLASS SPESSORE 3 mm D: 40 x 15 x 10 H cm *PERSONALIZZABILE	PWPGPL0299	206	SP	1 PZ
	PORTA CONI CON ANGOLI VIVI IN PLEXIGLASS SPESSORE 5 mm D: 21 x 30 x 10 *PERSONALIZZABILE	PWPGPL0399	207	SP	1 PZ

# EXPOWORLD

IMMAGINE	DESCRIZIONE	CODICE E COLORE	PAG CAT	PREZZO	NOTE
	PORTA CONI SAGOMATO IN PLEXIGLASS SPESSORE 3 mm D: 21 x 30 x 10 *PERSONALIZZABILE	PWPGPL0499	207	SP	1 PZ
	PORTA CONI CON ANGOLO ARROTONDATO IN PLEXIGLASS SPESSORE 3 mm D: 21 x 30 x 15 *PERSONALIZZABILE	PWPGPL0599	207	SP	1 PZ
	PORTA MACARON IN PLEXIGLASS SPESSORE IN 3 mm *PERSONALIZZABILE	PWPGPL0699	207	SP	1 PZ
	SEGNAGUSTI CLASSICI IN PLEXIGLASS SPESSORE 3 mm D: 20 x 10 cm *PERSONALIZZABILE	PWPGPL0799	208	SP	1 PZ
	SEGNAGUSTI SAGOMATI IN PLEXIGLASS SPESSORE 3 mm D: 20 x 10 cm *PERSONALIZZABILE	PWPGPL0899	208	SP	1 PZ
	ALZATA PER FINGER FOOD IN PLEXIGLASS SPESSORE 5 mm D:21 x 30 x 5/10/15 H cm *PERSONALIZZABILE	PWFFPL0108	208	SP	1 PZ
	PORTA FINGER FOOD IN PLEXIGLASS SPESSORE 3 mm *PERSONALIZZABILE	PWFFPL0208	208	SP	1 PZ

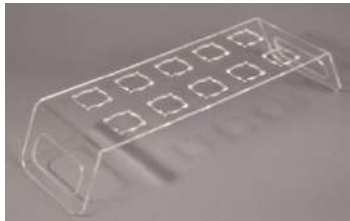

# EXPOWORLD

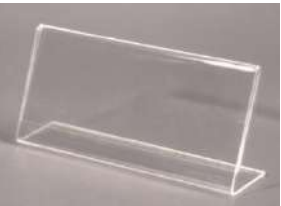
IMMAGINE	DESCRIZIONE	CODICE E COLORE	PAG CAT	PREZZO	NOTE
	ALZATA PER FINGER FOOD IN PLEXIGLASS SPESSORE 3 mm *PERSONALIZZABILE	PWFFPL0308	209	SP	1 PZ
	PORTA FINGER FOOD IN PLEXIGLASS SPESSORE 3 mm D: 15 x 40 x 8 cm *PERSONALIZZABILE	PWFFPL0408	209	SP	1 PZ
	PORTA MESSAGGI IN PLEXIGLASS SPESSORE 3 mm	PWESPL0108	209	SP	1 PZ
	PORTA VOLANTINI IN PLEXIGLASS SPESSORE 3 mm *PERSONALIZZABILE	PWESPL0208	209	SP	1 PZ
	PORTA VOLANTINI IN PLEXIGLASS SPESSORE 3 mm *PERSONALIZZABILE	PWESPL0308	210	SP	1 PZ
	PORTA MESSAGGI IN PLEXIGLASS SPESSORE 3 mm *PERSONALIZZABILE	PWESPL0408	210	SP	1 PZ
	PORTA MESSAGGI IN PLEXIGLASS SPESSORE 3 mm *PERSONALIZZABILE	PWESPL0508	210	SP	1 PZ

# EXPOWORLD

IMMAGINE	DESCRIZIONE	CODICE E COLORE	PAG CAT	PREZZO	NOTE
	ESPOSITORE PER SMARTPHONE IN PLEXIGLASS SPESSORE 3 mm *PERSONALIZZABILE	PWESPL0608	210	SP	1 PZ
	ESPOSITORE PER SMARTPHONE IN PLEXIGLASS SPESSORE 3 mm *PERSONALIZZABILE	PWESPL0708	211	SP	1 PZ
	ESPOSITORE PER SMARTPHONE IN PLEXIGLASS SPESSORE 3 mm *PERSONALIZZABILE	PWESPL1708	211	SP	1 PZ
	ESPOSITORE PER SMARTPHONE IN PLEXIGLASS SPESSORE 3 mm *PERSONALIZZABILE	PWESPL1808	211	SP	1 PZ
	CONTENITORE IN PLEXIGLASS SPESSORE 3 mm *PERSONALIZZABILE	PWESPL2108	211	SP	1 PZ
	CONTENITORE PORTA MESSAGGI IN PLEXIGLASS SPESSORE 3 mm *PERSONALIZZABILE	PWESPL2208	212	SP	1 PZ
	CONTENITORE PORTA MESSAGGI IN PLEXIGLASS SPESSORE 3 mm *PERSONALIZZABILE	PWESPL2308	212	SP	1 PZ

# EXPOWORLD

IMMAGINE	DESCRIZIONE	CODICE E COLORE	PAG CAT	PREZZO	NOTE
	CONTENITORE DA PAVIMENTO IN PLEXIGLASS SPESSORE 3 mm *PERSONALIZZABILE	PWESPL2408	212	SP	1 PZ
	CONTENITORE IN PLEXIGLASS SPESSORE 3 mm D: 22 x 15 H cm *PERSONALIZZABILE	PWBSPL0108	212	SP	1 PZ
	CONTENITORE CON CHIAVE IN PLEXIGLASS SPESSORE 3 mm D: 22 x 15 H cm *PERSONALIZZABILE	PWBSPL0208	213	SP	1 PZ
	MENSOLA IN PLEXIGLASS SPESSORE 3 mm D: 22 x 15 H cm *PERSONALIZZABILE	PWBSPL0308	213	SP	1 PZ
	SCATOLA IN PLEXY CON COPERCHIO D: 20cm H ø 20 cm	PWBSPL0408	213	SP	1 PZ
	PORTA FOGLI DA INCARTO IN PMMA	PWBSPLXXXX	213	SP	1 PZ
	MINI VASSOIO DA BANCO IN PLEXIGLASS ICE SP. 5 mm D: 14 x 14 x 4 cm	STPLXICEALZ	215	SP	1 PZ

# EXPOWORLD

IMMAGINE	DESCRIZIONE	CODICE E COLORE	PAG CAT	PREZZO	NOTE
	VASSOIO DA BANCO IN PLEXIGLASS ICE SP. 5 mm D: 36 x 25 cm	STPLXICEVSS	215	SP	1 PZ
	VASSOIO CIRCOLARE FLUTE IN PLEXIGLASS ICE SP. 5 mm D: Ø 30 cm	STPLX300ICEFLUTE	215	SP	1 PZ
	PORTA FLUTE IN PLEXIGLASS ICE SP. 5 mm D: 50 x 18 cm	STPLXICEFLU1	215	SP	1 PZ
	VASSOIO CIRCOLARE IN PLEXIGLASS ICE SP. 5 mm D: Ø 27 cm	STPLXICEVSS1	215	SP	1 PZ
	VASSOIO RETTANGOLARE IN PLEXIGLASS ICE SP. 5 mm D: 35 x 15 cm	STPLXICEVSS2	215	SP	1 PZ
	PORTAFLUTE IN PLEXIGLASS ICE SP. 5 mm D: 56 x 20 x 12 cm	STPLXICEFLU	215	SP	1 PZ
	ALZATA FINGER FOOD 3 P. IN PLEXIGLASS ICE SP. 5 mm D: 10 x 35 x 14 cm	STPLXICEFFOOD1	215	SP	1 PZ





# EXPOWORLD

IMMAGINE	DESCRIZIONE	CODICE E COLORE	PAG CAT	PREZZO	NOTE
	ALZATA FINGER FOOD 10 P. IN PLEXIGLASS ICE SP. 5 mm D: 50 x 10 x 10 cm	STPLXICEFFOOD	215	SP	1 PZ
	PORTA BOTTIGLIE INCLINATO IN PLEXIGLASS ICE SP. 5 mm D: 27 x 8 x 12 cm	STPLXICEBOTT	215	SP	1 PZ
	ALZATA INCLINATA 10 P. IN PLEXIGLASS ICE SP. 5 mm D: 15 x 50 x 20 cm	STPLXICEFFOOD2	215	SP	1 PZ
	CESTELLO PER GHIACCIO IN PLEXIGLASS ICE SP. 5 mm D: 20 x 20 x 30 cm	STPLXICEFFOOD	215	SP	1 PZ

# IGIENE E AMBIENTE

IMMAGINE	DESCRIZIONE	CODICE E COLORE	PAG CAT	PREZZO	NOTE
	DETERSIVO PIATTI 5LT PROFUMAZIONE LIMONE	IAIPDTP001	223	SP	CONF DA 4 PZ
	DETERSIVO LAVASTOVIGLIE ACQUE MEDIE/DOLCI 5LT	IAIPDTL001	223	SP	CONF DA 4 PZ
	BRILLANTANTE PER LAVASTOVIGLIE 5LT	IAIPBRI001	223	SP	CONF DA 4 PZ
	DETERGENTE PER LAVABICCHIERI E LAVABAR 5LT	IAIPDDET04	223	SP	CONF DA 4 PZ
	DISINCROSTANTE PER FORNI E GRILL 5LT	IAIPDIF001	223	SP	CONF DA 4 PZ

# IGIENE E AMBIENTE

IMMAGINE	DESCRIZIONE	CODICE E COLORE	PAG CAT	PREZZO	NOTE
	DETERGENTE PER SUPERFICI DURE E ACCIAIO 5LT	IAIPDDET05	223	SP	CONF DA 4 PZ
	DETERGENTE LAVAPAVIMENTI AL GELSOMINO E NARCISO 5LT	IAIPDDET06	223	SP	CONF DA 4 PZ
	DETERGENTE IGIENIZZANTE A BASE ALCOLICA 750ML	IAIPDDET08	223	SP	CONF DA 12 PZ
	DISGORGANTE NO ACIDO 1LT	IAIPDDIS01	224	SP	
	SGRASSATORE MULTIUSO SPRAY 750 ML	IAIPSGR004	224	SP	CONF DA 12 PZ

# IGIENE E AMBIENTE



IMMAGINE	DESCRIZIONE	CODICE E COLORE	PAG CAT	PREZZO	NOTE
	SGRASSATORE CONCENTRATO ADATTO A MACCHINE LAVAPIATTI 5LT	IAIPSGR003	224	SP	CONF DA 4 PZ
	SGRASSATORE CONCENTRATO SPRAY ADATTO A MACCHINE 750 ML	IAIPSGR002	224	SP	CONF DA 12 PZ
	DETERGENTE IGIENIZZANTE MULTIUSO PER AREE FOOD 750ML	IAIPDDET09	224	SP	CONF DA 12 PZ
	DISINFETTANTE DETERGENTE MULTIUSO DEODORANTE 5LT	IAIPDDET01	224	SP	CONF DA 4 PZ
	DISINFETTANTE DETERGENTE MULTIUSO ULTRA CONCENTRATO 5LT	IAIPDDET03	224	SP	CONF DA 4 PZ



# IGIENE E AMBIENTE

IMMAGINE	DESCRIZIONE	CODICE E COLORE	PAG CAT	PREZZO	NOTE
	DETERGENTE CONCENTRATO PER SANITARI 5LT	IAIPDDET07	224	SP	CONF DA 4 PZ
	DISINFETTANTI SAPONE MANI 5LT	IAIPDMA001	225	SP	CONF DA 4 PZ
	DETERGENTE NEUTRO PER LE MANI 5LT	IAIPDMA002	225	SP	CONF DA 4 PZ
	CARRELLO CON STRIZZATORE A PRESSA CARRELLO 2 x 15 LT	IACHCAR001	225	€ 323,17	
	CARRELLO MONOSECCHIO CON STRIZZATORE IN PLASTICA	IACHCAR002	225	€ 214,61	

# IGIENE E AMBIENTE

IMMAGINE	DESCRIZIONE	CODICE E COLORE	PAG CAT	PREZZO	NOTE
	CARRELLO PORTASACCO DOPPIO SECCHIO	IACHCAR003	225	€ 405,83	
	STRIZZATORE A RULLO	IACHSTR002	226	€ 175,61	
	STRIZZATORE IN PLASTICA COMPLETO DI GANCIO	IACHSTR001	226	€ 113,76	
	MANICO IN ALLUMINIO CON FORO 145 cm	IACHMAN001	226	€ 18,73	
	MANICO IN ALLUMINIO CON FILETTO 140 cm	IACHMAN002	226	€ 14,90	

# IGIENE E AMBIENTE

IMMAGINE	DESCRIZIONE	CODICE E COLORE	PAG CAT	PREZZO	NOTE
	TELAIO CLACK 40 x 11 cm	IACHTEL001	226	€ 54,26	
	FRANCIA IN MICROFIBRA SUPER SCIVOLOSA 40 cm CON ALETTE	IACHFRA001	227	€ 18,97	
	PINZA IN PLASTICA PER MOP	IACHPIN001	227	€ 7,45	
	MOP COTONE EXTRA SENZA BANDA 400 gr	IACHMOP001	227	€ 9,63	
	MOP MICROFIBRA CON ATTACCO A VITE 200 gr	IACHMOP002	227	€ 16,53	

# IGIENE E AMBIENTE

IMMAGINE	DESCRIZIONE	CODICE E COLORE	PAG CAT	PREZZO	NOTE
	SECCHIELLO STRIZZA MOP ROSSO 15 LT	IACHSEC001	227	€ 25,20	
	SECCHIO A DUE VASCHE CON STRIZZINO	IACHSEC002	227	€ 46,61	
	SET PALETTA + SCOPA E GANCIO	IACHSET001	227	€ 40,73	
	PANNO IN MICROFIBRA D: 40 x 40 cm	IACHPAN001	227	€ 7,28	
	STROFINACCIO 3 VELI/800 STRAPPI	IACHSTR001	227	€ 48,45	CONF DA 2 RT
	STROFINACCIO 2 VELI/1250 STRAPPI	IACHSTR002	227	€ 21,62	CONF DA 2 RT
	STROFINACCIO 2 VELI/800 STRAPPI	IACHSTR003	227	€ 31,72	CONF DA 2 RT

# IGIENE E AMBIENTE

IMMAGINE	DESCRIZIONE	CODICE E COLORE	PAG CAT	PREZZO	NOTE
	SUPPORTO CARENATO DA PARETE D: 36 x 31,5 x 34 cm	IAMRPRT777	228	€ 97,04	
	SUPPORTO CARENATO DA APPOGGIO D: 44 x 34 x 33 cm	IAMRPRT635	228	€ 90,61	
	CAVALLETTO CARENATO PER BOBINA D: 51,5 x 47 x 94 cm	IAMRPRT638	228	€ 173,40	
	CONFEZIONE 2 BOBINE INDUSTRIALI 3 VELI L: 170 MT	IAMRRTA997	228	€ 67,98	SENZA PRETAGLIO
	DISPENSER FOGLI DI CARTA ASCIUGAMANI A V (600 fg) D: 29 x 13 x 40 cm	IAMRDIS831	228	€ 65,14	

# IGIENE E AMBIENTE

IMMAGINE	DESCRIZIONE	CODICE E COLORE	PAG CAT	PREZZO	NOTE
	DISPENSER FOGLI DI CARTA ASCIUGAMANI A V (300 fg) D: 30 x 19,5 x 25,1 cm	IAMRDIS601	228	€ 57,80	
	CARTA ASCIUGAMINI PIEGATI A V 2 VELI PURA CELLULOSA D: 15 x 25 cm 3750 fg	IAMRFFC953	229	€ 171,98	
	ASCIUGAMANI ELETTRONICO IN ACCIAIO INOX 2500 W D: 26,7 x 16,4 x 32,5 cm	IAMRASE754	229	€ 864,79	
	ASCIUGAMANI ELETTRONICO IN ABS 950 W D: 14,5 x 13,8 x 25,8 cm	IAMRASE848	229	€ 325,34	
	ASCIUGAMANI PIEGATI A V CELLULOSA 2 VELI 200 fg	IACHASC001	229	€ 47,74	CONF DA 15 PZ

# IGIENE E AMBIENTE

IMMAGINE	DESCRIZIONE	CODICE E COLORE	PAG CAT	PREZZO	NOTE
	BIDONE CON PEDALE DA 120 LT D: 48 x 48 x 93 H cm	IABPB12001 IABPB12002 IABPB12003 IABPB12004 IABPB12006 IABPB12007	231	€ 151,95 (01/07) SP (02/03/04/06)	
	SACCO IMMONDIZIA NERO 120LT	IABP951205	231	SP	CONF 200 PZ
	BIDONE CON PEDALE DA 80 LT D: 48 x 48 x 93 H cm	IABPB08001 IABPB08010	231	€ 89,90 (01) SP(10)	
	SACCO IMMONDIZIA NERO 80LT	IABP958005	231	SP	CONF 300 PZ
	BIDONE INDUSTRIALE 75 LT D: 48 x 57 cm	IABCB07501	231	€ 38,94	
	BIDONE INDUSTRIALE 100 LT D: 52 x 67 cm	IABCB10001	231	€ 49,70	
	BIDONE INDUSTRIALE 150 LT D: 62 x 71 cm	IABCB15001	231	€ 57,75	

# IGIENE E AMBIENTE

IMMAGINE	DESCRIZIONE	CODICE E COLORE	PAG CAT	PREZZO	NOTE
	COPERCHIO PER BIDONE 75 LT	IABCC07501	231	€ 11,40	
	COPERCHIO PER BIDONE 100 LT	IABCC10001	231	€ 12,32	
	COPERCHIO PER BIDONE 150 LT	IABCC15001	231	€ 13,55	
	BANDA ADESIVA IN PVC DI COLORE VERDE PER BIDONE INDUSTRIALE	IABCA07507	231	€ 3,30	
	BANDA ADESIVA IN PVC DI COLORE VERDE PER BIDONE INDUSTRIALE	IABCA10007	231	€ 3,30	
	BANDA ADESIVA IN PVC DI COLORE VERDE PER BIDONE INDUSTRIALE	IABCA15007	231	€ 3,30	
	CARRELLO PER BIDONE INDUSTRIALE DA 75 LT E 100 LT	IABPC19112	232	€ 185,43	
	CASSONETTO 4 RUOTE 660 LT	IABPM66002 IABPM66003 IABPM66004 IABPM66007 IABPM66010	232	€ 561,81	
	CASSONETTO 4 RUOTE 770 LT	IABPM77002 IABPM77003 IABPM77004 IABPM77007 IABPM77010	232	€ 587,52	



# IGIENE E AMBIENTE

IMMAGINE	DESCRIZIONE	CODICE E COLORE	PAG CAT	PREZZO	NOTE
	CASSONETTO 4 RUOTE 1100 LT	IABPM11102 IABPM11103 IABPM11104 IABPM11107 IABPM11110	232	€ 752,77	
	BIDONCINO RACCOLTA DIFFERENZIATA 25 LT	IABPG02502 IABPG02503 IABPG02504 IABPG02507	233	€ 24,60	
	SACCO IMMONDIZIA NERO 25 LT	IABP952505	233	SP	CONF 300 PZ
	BIDONCINO RACCOLTA DIFFERENZIATA 35 LT	IABPG03502 IABPG03503 IABPG03507 IABPG03510	233	€ 27,59	
	SACCO IMMONDIZIA NERO 45 LT	IABP954505	233	SP	CONF 300 PZ

# IGIENE E AMBIENTE

IMMAGINE	DESCRIZIONE	CODICE E COLORE	PAG CAT	PREZZO	NOTE
	TRESPOLO GRIGIO CON COPERCHIO COLORATO 110 LT	IABPG11002 IABPG11003 IABPG11004 IABPG11007	233	€ 86,30	
	SACCO IMMONDIZIA NERO 120 LT	IABP951205	233	SP	CONF 200 PZ
	TRESPOLO 110 LT	IABPM11002 IABPM11003 IABPM11004 IABPM11007	233	€ 86,30	
	SACCO IMMONDIZIA NERO 120 LT	IABP951205	233	SP	CONF 200 PZ
	BIDONE CARRELLATO 240 LT CON COPERCHIO COLORATO	IABPG24002 IABPG24003 IABPG24004 IABPG24007	234	€ 194,60	

# IGIENE E AMBIENTE

IMMAGINE	DESCRIZIONE	CODICE E COLORE	PAG CAT	PREZZO	NOTE
	SACCO IMMONDIZIA NERO 240 LT	IABP952405	234	SP	CONF 100 PZ
	BIDONE MEDICINALI SCADUTI 25 LT D: 32 x 28 x 67 H cm	IABPRMSF01	234	€ 499,00	
	RACCOGLITORE BATTERIE ESAUSTE IN LAMIERA ZINCATA GIALLA 25 LT D: 32 x 28 x 67 H cm	IABPRBUF03	234	€ 499,00	
	RACCOGLITORE BATTERIE ESAUSTE D: ø 33 x 102 H cm	IABPBUPV05	234	€ 159,50	
	CONTENITORE BATTERIE ESAUSTE 3 LT D: 14,9 X 22,2 X 20 H cm	IABPBU0301	235	€ 18,60	

# IGIENE E AMBIENTE

IMMAGINE	DESCRIZIONE	CODICE E COLORE	PAG CAT	PREZZO	NOTE
	CONTENITORE BATTERIE ESAUSTE 7 LT D: 25 X 25,5 X 21,7 H cm	IABPBU0701	235	€ 12,75	
	RACCOGLITORE BATTERIE ESAUSTE IN PMMA CON CONTENITORE 3LT D: 40 x 30 x 130 H cm	IABPBUPLXX	235	€ 136,00	
	PALO CON BASE 40 x 40 x 91 H cm	IABPPIAN05	235	€ 146,52	
	STAFFA IN METALLO PER FISSAGGIO A PARETE D: 22 x 13 x 3 H cm	IABPSTAF05	235	€ 34,15	
	ADESIVO "BATTERIE ESAUSTE" IN PVC TRASPARENTE D: 8 x 12 cm	IABPAD0308	235	€ 8,00	

# IGIENE E AMBIENTE

IMMAGINE	DESCRIZIONE	CODICE E COLORE	PAG CAT	PREZZO	NOTE
	ADESIVO BIANCO OPACO "BATTERIE USATE" D: 16 x 8cm	IABPAD0701	235	€ 10,00	
	ADESIVO PRESPAZIATO CROCE ROSSA D: 16 x 16 cm	IABPADCR06	235	€ 12,00	

# GESTIONE CODE E VIDEOCOMUNICAZIONE

IMMAGINE	DESCRIZIONE	CODICE E COLORE	PAG CAT	PREZZO	NOTE
	BOX ELIMINACODE MULTIMEDIALE- AVANZAMENTO CODE DA PC	AVECSBMC05	240	SP	
	CODALUX MAXI 24" A COLONNA	AVECTMX01 AVECTMX05	243	SP	
	CODALUX MAXI 24" A PARETE	AVECTPX01 AVECTPX05	243	SP	
	STAMPANTE TERMICA NON FISCALE	MCEA00012	243	SP	
	LETTORE BARCODE 1D/2D	MCEA00027	243	SP	
	ROTOLO TERMICO 57 x 60	1TNV57X60	243	SP	CONF DA 50 PZ
	CODALUX 1 PULSANTE	CPSPJD0101 CPSPJD0105	244	SP	
	CODALUX 2 PULSANTI	CPSPJD0201 CPSPJD0205	244	SP	
	CODALUX 3 PULSANTI	CPSPJD0301 CPSPJD0305	244	SP	
	CODALUX 4 PULSANTI	CPSPJD0401 CPSPJD0405	244	SP	

# GESTIONE CODE E VIDEOCOMUNICAZIONE

IMMAGINE	DESCRIZIONE	CODICE E COLORE	PAG CAT	PREZZO	NOTE
	ROTOLO TERMICO 57 x 60	1TNV57X60	244	SP	CONF DA 50 PZ
	CODALUX TOUCH ECONOMY 10"	AVECTEQ01 AVECTEQ05	245	SP	
	ROTOLO TERMICO 80 x 80	TER80X80CDX	245	SP	CONF DA 50 PZ
	CODALUX TOUCH MODELLO A MONITOR 10"	AVECT5Q01 AVECT5Q05	246	SP	
	CODALUX TOUCH MODELLO A MONITOR 15"	AVECT5T05	246	SP	
	ROTOLO TERMICO 80 x 80	TER80X80CDX	246	SP	CONF DA 50 PZ

# GESTIONE CODE E VIDEOCOMUNICAZIONE

IMMAGINE	DESCRIZIONE	CODICE E COLORE	PAG CAT	PREZZO	NOTE
	CODALUX TOUCH MODELLO B MONITOR 15"	AVECT5B15H01 AVECT5B15H05	247	SP	
	CODALUX TOUCH MODELLO B MONITOR 17" VERTICALE	AVECT5B17V01 AVECT5B17V05	247	SP	
	CODALUX TOUCH MODELLO B MONITOR 24"	AVECT5B24H01 AVECT5B24H05	247	SP	
	CODALUX TOUCH MODELLO B MONITOR 24" VERTICALE	AVECT5B24V01 AVECT5B24V05	247	SP	
	ROTOLO TERMICO 57 x 60	1TNV57X60	247	SP	CONF DA 50 PZ
 <p>Monitor 15", 17", 24" Monitor 15", 17", 24"</p> <p>Lettura Barcode Barcode reading</p> <p>Stampa logo personalizzata Customized logo print</p> <p>Led colore fisso a scelta Choice of LED fixed colour</p> <p>Colore colonna personalizzabile Column colour customizable</p>	CODALUX TOUCH MODELLO C MONITOR 15"	AVECT5C15H01 AVECT5C15H05	248	SP	
	CODALUX TOUCH MODELLO C MONITOR 17" VERTICALE	AVECT5C17V01 AVECT5C17V05	248	SP	
	CODALUX TOUCH MODELLO C MONITOR 24"	AVECT5C24H01 AVECT5C24H05	248	SP	
	CODALUX TOUCH MODELLO C MONITOR 24" VERTICALE	AVECT5C24V01 AVECT5C24V05	248	SP	
	ROTOLO TERMICO 57 x 60	1TNV57X60	248	SP	CONF DA 50 PZ







# GESTIONE CODE E VIDEOCOMUNICAZIONE

IMMAGINE	DESCRIZIONE	CODICE E COLORE	PAG CAT	PREZZO	NOTE
	CODALUX MODELL A WALL 10"	AVECT10P01 AVECT10P05	249	SP	
	CODALUX MODEL A WALL 15"	AVECT5P1501 AVECT15P05	249	SP	
	ROTOLO TERMICO 80 x 80	TER80X80CDX	249	SP	CONF DA 50 PZ
	STAFFA 20 x 13 cm	AVECSTFE01 AVECSTFE05	249	SP	
 <p>*SENZA STAMPANTE</p>	CODALUX TOUCH SCREEN MENÙ MONITOR 15"	AVECT5M15H01 AVECT5M15H05	250	SP	
	CODALUX TOUCH SCREEN MENÙ MONITOR 17"	AVECT5M17H01 AVECT5M17H05	250	SP	
	CODALUX TOUCH SCREEN MENÙ MONITOR 22"	AVECT5M22H01 AVECT5M22H05	250	SP	
	CODALUX TOUCH SCREEN MENÙ MONITOR 22" VERTICALE	AVECT5M22V01 AVECT5M22V05	250	SP	
	CODALUX TOUCH SCREEN MENÙ MONITOR 24"	AVECT5M24H01 AVECT5M24H05	250	SP	
	CODALUX TOUCH SCREEN MENÙ MONITOR 24" VERTICALE	AVECT5M24V01 AVECT5M24V05	250	SP	
	CODALUX TOUCH SCREEN MENÙ MONITOR 27"	AVECT5M27H01 AVECT5M27H05	250	SP	
	CODALUX TOUCH SCREEN MENÙ MONITOR 32"	AVECT5M32H01 AVECT5M32H05	250	SP	





# GESTIONE CODE E VIDEOCOMUNICAZIONE

IMMAGINE	DESCRIZIONE	CODICE E COLORE	PAG CAT	PREZZO	NOTE
	INDICATORE DI POSTAZIONE DA BANCO IN ACR SPESSORE 2 mm	CGEBA4VR08	252	SP	
	INDICATORE DI POSTAZIONE CON BIADESIVO IN PLEXI 3 mm	INDICPLEXCB	252	SP	
	INDICATORE DI POSTAZIONE ILLUMINATO APPENDIBILE	INDICPLEXIA	252	SP	
	STAFFA INCLINABILE	STA00001	252	SP	
	STAFFA FULL MOTION	STA00002	252	SP	
	STAFFA ULTRA SLIM FULL MOTION	STA00003	252	SP	
	STAFFA INCLINABILE XL	STA00004	252	SP	







# GESTIONE CODE E VIDEOCOMUNICAZIONE

IMMAGINE	DESCRIZIONE	CODICE E COLORE	PAG CAT	PREZZO	NOTE
	STAFFA DA BANCO	STA00005	252	SP	
	STAFFA A SOFFITTO	STA00006	252	SP	
	KIT POWERLINE	MCEG00320	253	SP	
	CAVO DI RETE LAN CCA CAT 5E 1 Mt	MCEW00022	253	SP	
	CAVO DI RETE LAN CCA CAT 5E 2 Mt	MCEW00047	253	SP	
	EXTENDER WIFI	EW00001	253	SP	
	SWITCH DI RETE LAN	MCEG00319	253	SP	
	ROUTER/ACCESS POINT	MCEI00317	253	SP	

# GESTIONE CODE E VIDEOCOMUNICAZIONE

IMMAGINE	DESCRIZIONE	CODICE E COLORE	PAG CAT	PREZZO	NOTE
	CAVO HDMI HIGH SPEED CON ETHERNET 1 Mt	MCEW00060	253	SP	
	CAVO HDMI HIGH SPEED CON ETHERNET 2 Mt	MCEW00059	253	SP	
	CAVO HDMI HIGH SPEED CON ETHERNET 3 Mt	MCEW00340	253	SP	
	CAVO HDMI HIGH SPEED CON ETHERNET 5 Mt	MCEW00341	253	SP	
	CAVO HDMI HIGH SPEED CON ETHERNET 10 Mt	MCEW00062	253	SP	
	SPLITTER HDMI 2 VIE	MCEA00065	253	SP	
	SPLITTER HDMI 4 VIE	MCEA00450	253	SP	
	COPPIA CASSE	MCEG00369	253	SP	
	INTERFONO	INTC00001	253		

# GESTIONE CODE E VIDEOCOMUNICAZIONE

IMMAGINE	DESCRIZIONE	CODICE E COLORE	PAG CAT	PREZZO	NOTE
	VISORE A LED MODELLO VS2 A DUE CIFRE IN ABS COMPLETO DI STAFFA DI MONTAGGIO ALIMENTAZIONE 12VDC *SISTEMA VOCALE INTEGRATO	VS2	255	€ 250,00	
	TELECOMANDO MODELLO TC1 CON DISPLAY LCD PER VISORI "TOP VISOR"	TC1	255	€ 75,00	
	CARICABATTERIA PER TELECOMANDO TC1 5V 1.2A	VD002	255	€ 20,00	
	ALIMENTATORE PER VISORE VS2 12V 2A	VD056	255	€ 17,50	
	STAFFA BIFACCIALE	AVECMT0205	255		
	STAFFA TRIFACCIALE	AVECMT0105	255		





# GESTIONE CODE E VIDEOCOMUNICAZIONE

IMMAGINE	DESCRIZIONE	CODICE E COLORE	PAG CAT	PREZZO	NOTE
	<p>VISORE A LED MODELLO VD1 A DUE CIFRE 120 mm IN ABS COMPLETO DI STAFFA DI MONTAGGIO ALIMENTAZIONE VAC/VDC</p> <p>*POSSIBILE APPLICAZIONE DI SISTEMA VOCALE WIRELESS</p>	<p>AVECDP0101 AVECDP0102 AVECDP0103 AVECDP0105 AVECDP0106 AVECDP0107</p>	256	<p>€ 220,50 € 220,50 € 220,50 € 199,50 € 220,50 € 220,50</p>	
	<p>VISORE A LED MODELLO VD3 A DUE CIFRE 120 mm IN ABS COMPLETO DI STAFFA DI MONTAGGIO ALIMENTAZIONE VAC/VDC</p> <p>*POSSIBILE APPLICAZIONE DI SISTEMA VOCALE VIA CAVO</p>	<p>AVECDP0301 AVECDP0302 AVECDP0303 AVECDP0305 AVECDP0306 AVECDP0307</p>	256	<p>€ 204,75 € 204,75 € 204,75 € 183,75 € 204,75 € 204,75</p>	
	<p>RADIOCOMANDO MODELLO VT1 PER VISORE VD1</p>	AVECRC01	256	€ 31,47	
	<p>RADIOCOMANDO MODELLO VT2 CON DISPLAY LCD A 2 CIFRE PER VISORE VD1</p>	AVECRC02	256	€ 64,79	
	<p>RADIOCOMANDO MODELLO VT3 PER VISORE VD3</p>	AVECRC03	256	€ 31,47	
	<p>RADIOCOMANDO MODELLO VTVS PER VISORE COMPATIBILE</p>	AVECRC05	256	€ 31,47	

# GESTIONE CODE E VIDEOCOMUNICAZIONE



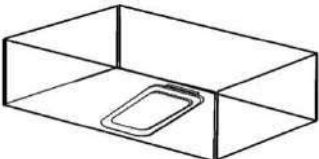

IMMAGINE	DESCRIZIONE	CODICE E COLORE	PAG CAT	PREZZO	NOTE
	STAFFA TRIFACCIALE *VISORI ESCLUSI	AVECMT01	256	€ 191,30	
	STAFFA TRIFACCIALE CON 3 VISORI A DUE CIFRE	AVECMT02	256	€ 772,75	
	SISTEMA VOCALE VD3 CON ALIMENTAZIONE VIA CAVO	AVECSV0105	256	€ 264,00	
	SISTEMA VOCALE VD1 WIRELESS	AVECSV0205	256	€ 284,00	
	DISTRIBUTORE A CHIOCCIOLA VX1	AVECCH0102 AVECCH0103 AVECCH0106 AVECCH0107	257	€ 19,80	
	DISTRIBUTORE A LEVA VX3	AVECCH0305 AVECCH0306	257	SP (05) € 66,30 (06)	
	SUPPORTO DA PARETE PER VX3 IN FE	AVECCH0405	257	€ 16,50	
	TICKET PROGRESSIONE NUMERICA ADATTI AL DISTRIBUTORE VX1	AVECT240	257	€ 126,60	CONF DA 40 ROTOLI
	TICKET PROGRESSIONE NUMERICA ADATTI AL DISTRIBUTORE VX1	AVECT205	257	€ 18,20	CONF DA 5 ROTOLI

# GESTIONE CODE E VIDEOCOMUNICAZIONE

IMMAGINE	DESCRIZIONE	CODICE E COLORE	PAG CAT	PREZZO	NOTE
	TICKET A PROGRESSIONE ALFANUMERICA ADATTI AL DISTRIBUTORE VX1	AVECT140	257	€ 126,60	CONF DA 40 ROTOLI
	TICKET A PROGRESSIONE ALFANUMERICA ADATTI AL DISTRIBUTORE VX1	AVECT105	257	€ 18,20	CONF DA 5 ROTOLI
	TICKET ALFANUMERICI ADATTI AL DISTRIBUTORE VX3	AVECT310	257	SP	CONF DA 10 ROTOLI
	TICKET ALFANUMERICI ADATTI AL DISTRIBUTORE VX3	AVECT315	257	SP	CONF DA 15 ROTOLI
	CARTELLO INFORMATIVO BIFACCIALE COMPLETO DI CORNICE	AVECVP04	257	€ 5,00	
	RACCOGLITORE TICKET IN PLEXIGLASS CON CLIP A CHIOCCIOLA	AVECRT0208	257	€ 19,80	
	RACCOGLITORE TICKET IN PLEXIGLASS CON VENTOSE	AVECRT0108	257	€ 19,80	
	RACCOGLITORE TICKET IN PLEXIGLASS CON MOLLETTONE	AVECRT0308	257	€ 19,80	



# GESTIONE CODE E VIDEOCOMUNICAZIONE

IMMAGINE	DESCRIZIONE	CODICE E COLORE	PAG CAT	PREZZO	NOTE
	PIANTANA VP1 H: 140 cm	AVECVP0105	258	€ 126,72	
	PIANTANA VP2 H:135 cm	AVECVP0205	258	€ 79,12	
	PIANTANA VP3 H: 134 cm	AVECVP0305	258	€ 61,38	
	COLONNINA TENDINASTRO SILVER D: 91 H cm *COLORI NATSRO: 02-05-06	SP80302 SP80305 SP80306	259	SP	
	COLONNINA TENDINASTRO NERO D: 91 H cm *COLORI NATSRO: 02-05-06	SP91302 SP91305 SP91306	259	€ 82,30	
	RULLO TENDINASTRO A MURO SILVER *COLORI NATSRO: 02-05-06	RU80302 RU80305 RU80306	259	SP	
	RULLO TENDINASTRO A MURO NERO *COLORI NATSRO: 02-05-06	RU91302 RU91305 RU91306	259	€ 66,50	



# GESTIONE CODE E VIDEOCOMUNICAZIONE

IMMAGINE	DESCRIZIONE	CODICE E COLORE	PAG CAT	PREZZO	NOTE
	ATTACCO FINALE A MURO	ATTMUR	259	€ 17,20	
	DELIMITATORE A CORDONE SILVER D: 91 H cm	SPCR02 SPCR05 SPCR06	259	SP	
	CONTABANCONOTE	AVAVCB61	271	SP	
	VERIFICA BANCONOTE CON BATTERIA RICARICABILE	AVAVSXBT	271	ND	
	VERIFICA BANCONOTE CON SOLA ALIMENTAZIONE VIA CAVO	AVAVSXWB	271	€ 195,33	
	CONTA MONETE	AVAVCM10	271	€ 391,00	

# GESTIONE CODE E VIDEOCOMUNICAZIONE

IMMAGINE	DESCRIZIONE	CODICE E COLORE	PAG CAT	PREZZO	NOTE
	UNITÀ DISATTIVATORE CON PIATTO ACUSTOMAGNETICO	DVA2050	272	€ 732,60	1 PZ
	DISTACCATORE MECCANICO ACUSTOMAGNETICO	DTAMAN00	272	€ 199,80	1 PZ
	DISTACCATORE SUPER CONICO	DTUCON00	272	€ 107,52	1 PZ
	DISTACCATORE SUPER ELEGANCE	DTUELE00	272	€ 107,52	1 PZ
  *AD ESAURIMENTO SCORTE	PROTEZIONE ADESIVA PER SISTEMA ACUSTICO MAGNETICO D: 1,1 x 4,4 cm KE FALSO BARCODE	SLAKE000	272	€ 1.198,80	CONF DA 20000 PZ
		SLAKE000BL	FC	€ 359,64	CONF DA 20000 PZ
	PROTEZIONE ADESIVA PER SISTEMA ACUSTICO MAGNETICO D: 1,1 x 4,4 cm KE NERA	SLAKE001	272	ND	CONF DA 20000 PZ
		SLAKE001BL	FC	ND	CONF DA 20000 PZ
	PROTEZIONE ADESIVA PER SISTEMA ACUSTICO MAGNETICO D: 1,1 x 4,4 cm KE BIANCA	SLAKE002	272	ND	CONF DA 20000 PZ
		SLAKE002BL	FC	ND	CONF DA 20000 PZ





# GESTIONE CODE E VIDEOCOMUNICAZIONE

IMMAGINE	DESCRIZIONE	CODICE E COLORE	PAG CAT	PREZZO	NOTE
 <p>*SENSIBILITÀ MEDIA</p>	PROTEZIONE ADESIVA PER SISTEMA ACUSTICO MAGNETICO D: 1,1 x 4,4 cm KG FALSO BARCODE	SLAKG000	272	€ 1.332,00	CONF DA 20000 PZ
		SLAKG000BL	FC	€ 399,64	BLISTER DA 5000 PZ
	PROTEZIONE ADESIVA PER SISTEMA ACUSTICO MAGNETICO D: 1,1 x 4,4 cm KG BIANCA	SLAKG001	272	€ 1.351,80	CONF DA 20000 PZ
		SLAKG001BL	FC	€ 459,54	BLISTER DA 5000 PZ
	PROTEZIONE ADESIVA PER SISTEMA ACUSTICO MAGNETICO D: 1,1 x 4,4 cm KG NERA	SLAKG002	272	€ 1.351,80	CONF DA 20000 PZ
		SLAKG002BL	FC	€ 459,54	BLISTER DA 5000 PZ
 <p>*ALTA SENSIBILITÀ</p>	PROTEZIONE ADESIVA PER SISTEMA ACUSTICO MAGNETICO D: 1,1 x 4,4 cm KM FALSO BARCODE	SLAKM000	272	€ 1.531,80	CONF DA 20000 PZ
		SLAKM000BL	FC	€ 459,54	BLISTER DA 5000 PZ
	PROTEZIONE ADESIVA PER SISTEMA ACUSTICO MAGNETICO D: 1,1 x 4,4 cm KM BIANCA	SLAKM001	272	€ 1.665,00	CONF DA 20000 PZ
		SLAKM001BL	FC	€ 499,50	BLISTER DA 5000 PZ
	PROTEZIONE ADESIVA PER SISTEMA ACUSTICO MAGNETICO D: 1,1 x 4,4 cm KM NERA	SLAKM002	272	€ 1.665,00	CONF DA 20000 PZ
		SLAKM002BL	FC	€ 2.703,96	BLISTER DA 5000 PZ

# GESTIONE CODE E VIDEOCOMUNICAZIONE

IMMAGINE	DESCRIZIONE	CODICE E COLORE	PAG CAT	PREZZO	NOTE
	PROTEZIONE ADESIVA PER SISTEMA ACUSTICO MAGNETICO D: 0,7 x 4,4 cm KP FALSO BARCODE	SLAKP000	273	€ 2.564,10	CONF DA 28000 PZ
		SLAKP000BL	FC	€ 769,23	BLISTER DA 7000 PZ
	PROTEZIONE ADESIVA PER SISTEMA ACUSTICO MAGNETICO D: 0,7 x 4,4 cm KP BIANCA	SLAKP001	273	€ 2.703,96	CONF DA 28000 PZ
		SAKP001BL	FC	€ 811,20	BLISTER DA 7000 PZ
	PROTEZIONE ADESIVA PER SISTEMA ACUSTICO MAGNETICO D: 0,7 x 4,4 cm KP NERA	SLAKP002	273	€ 2.703,96	CONF DA 28000 PZ
		SLAKP002BL	FC	€ 811,20	BLISTER DA 7000 PZ
	PLACCA PROTETTIVA SUPERTAG GRIGIA PER SISTEMA ACUSTICO MAGNETICO	HTA3001SUPT1	273	€ 554,40	CONF DA 1000 PZ
	PLACCA PROTETTIVA SUPER TAG2 GRIGIA PER SISTEMA ACUSTICO MAGNETICO	HTA3002SUPT2	273	€ 554,40	CONF DA 1000 PZ
	PLACCA PROTETTIVA BIGPEN GRIGIA PER SISTEMA ACUSTICO MAGNETICO	HTA3010BIGP	273	€ 499,50	CONF DA 1000 PZ
	PLACCA PROTETTIVA MIDIPEN GRIGIA PER SISTEMA ACUSTICO MAGNETICO	HTA5001MIDP	273	€ 499,50	CONF DA 1000 PZ





# GESTIONE CODE E VIDEOCOMUNICAZIONE

IMMAGINE	DESCRIZIONE	CODICE E COLORE	PAG CAT	PREZZO	NOTE
	PLACCA PROTETTIVA TE5 SUPER NERA PER SISTEMA ACUSTICO MAGNETICO D: Ø 5 CM	HTA8029TE5BLK	273	€ 499,50	CONF DA 1000 PZ
	PLACCA PROTETTIVA TE5 SUPERGRIGIA PER SISTEMA ACUSTICO MAGNETICO D: Ø 5 CM	HTA8029TE5	273	€ 499,50	CONF DA 1000 PZ
	PLACCA PROTETTIVA RAGNO GRANDE PER SISTEMA ACUSTICO MAGNETICO D: Ø 7 CM	HTA2701SWB2	273	€ 1.598,40	CONF DA 200 PZ
	PLACCA PROTETTIVA RAGNO PICCOLO PER SISTEMA ACUSTICO MAGNETICO D: Ø 5 CM	HTA2501SWB2	273	€ 1.998,00	CONF DA 250 PZ
	COLLARINO PROTETTIVO PER BOTTIGLIA MINIPEN PER SISTEMA ACUSTICO MAGNETICO	HTA5301BOTLMN	273	€ 499,50	CONF DA 500 PZ
	LACCETTO ACCIAIO RICOPERTO PER SISTEMA ACUSTICO MAGNETICO L: 17 cm	LYU17ACP	273	€ 2.164,50	CONF DA 10000 PZ
	LACCETTO ACCIAIO RICOPERTO PER SISTEMA ACUSTICO MAGNETICO L: 17 cm	LYU17ACPBL	FC	€ 43,29	CONF DA 100 PZ
	LACCETTO ACCIAIO RICOPERTO PER SISTEMA ACUSTICO MAGNETICO L: 30 cm	LYU3001BCP	273	€ 2.164,50	CONF DA 10000 PZ
	LACCETTO ACCIAIO RICOPERTO PER SISTEMA ACUSTICO MAGNETICO L: 30 cm	LYU3001BCPL	FC	€ 43,29	CONF DA 100 PZ

# GESTIONE CODE E VIDEOCOMUNICAZIONE







IMMAGINE	DESCRIZIONE	CODICE E COLORE	PAG CAT	PREZZO	NOTE
	UNITÀ DISATTIVATORE RADIOFREQUENZA	DVR0282	274	€ 352,98	1 PZ
	DISTACCATORE SUPER CONICO RADIOFREQUENZA	DTUCON00	274	€ 106,56	1 PZ
	DISTACCATORE SUPER ELEGANCE RADIOFREQUENZA	DTUELE00	274	€ 106,56	1 PZ
	ETICHETTA ADESIVA HQ PER SISTEMA RADIOFREQUENZA FALSO BARCODE D: 2,9 x 2,6 cm	SLR292600	274	€ 905,76	CONF DA 20000 PZ
		SLR292600BL	FC	€ 108,69	BLISTER DA 2000 PZ
	ETICHETTA ADESIVA HQ PER SISTEMA RADIOFREQUENZA BIANCA NEUTRA D: 2,9 x 2,6 cm	SLR292600	274	€ 905,76	CONF DA 20000 PZ
		SLR292601BL	FC	€ 108,69	BLISTER DA 2000 PZ
	ETICHETTA ADESIVA HQ PER SISTEMA RADIOFREQUENZA FALSO BARCODE D: 3 x 3 cm	SLR303000	274	€ 905,76	CONF DA 20000 PZ
		SLR303000BL	FC	€ 108,69	BLISTER DA 2000 PZ
	ETICHETTA ADESIVA HQ PER SISTEMA RADIOFREQUENZA BIANCA NEUTRA D: 3 x 3 cm	SLR303001	274	€ 905,76	CONF DA 20000 PZ
		SLR303001BL	FC	€ 108,69	BLISTER DA 2000 PZ

# GESTIONE CODE E VIDEOCOMUNICAZIONE

IMMAGINE	DESCRIZIONE	CODICE E COLORE	PAG CAT	PREZZO	NOTE
	ETICHETTA ADESIVA HQ PER SISTEMA RADIOFREQUENZA FALSO BARCODE D: 4 x 3 cm	SLR403000	274	€ 799,20	CONF DA 20000 PZ
		SLR403000BL	FC	€ 95,90	BLISTER DA 2000 PZ
	ETICHETTA ADESIVA HQ PER SISTEMA RADIOFREQUENZA BIANCA NEUTRA D: 4 x 3 cm	SLR403001	274	€ 799,20	CONF DA 20000 PZ
		SLR403001BL	FC	€ 95,90	BLISTER DA 2000 PZ
	ETICHETTA ADESIVA HQ PER SISTEMA RADIOFREQUENZA FALSO BARCODE D: 4 x 4 cm	SLR404000	274	€ 772,56	CONF DA 20000 PZ
		SLR404000BL	FC	€ 92,70	BLISTER DA 2000 PZ
	ETICHETTA ADESIVA HQ PER SISTEMA RADIOFREQUENZA BIANCA NEUTRA D: 4 x 4 cm	SLR404001	274	€ 772,56	CONF DA 20000 PZ
		SLR404001BL	FC	€ 92,70	BLISTER DA 2000 PZ
	ETICHETTA ADESIVA STD PER SISTEMA RADIOFREQUENZA FALSO BARCODE D: 4 x 4 cm	SLR404000-30	275	€ 532,80	CONF DA 20000 PZ
		SLR404000-30BL	FC	€ 63,93	BLISTER DA 2000 PZ
	ETICHETTA ADESIVA STD PER SISTEMA RADIOFREQUENZA BIANCA NEUTRA D: 4 x 4 cm	SLR404001-30	275	€ 532,80	CONF DA 20000 PZ
		SLR404001-30BL	FC	€ 63,93	BLISTER DA 2000 PZ
	ETICHETTA ADESIVA HQ PER SISTEMA RADIOFREQUENZA FALSO BARCODE D: 5 x 5,2 cm	SLR505000	275	€ 932,40	CONF DA 20000 PZ
		SLR505000BL	FC	€ 111,89	BLISTER DA 2000 PZ
	ETICHETTA ADESIVA HQ PER SISTEMA RADIOFREQUENZA BIANCA NEUTRA D: 5 x 5,2 cm	SLR505001	275	€ 932,40	CONF DA 20000 PZ
		SLR505001BL	FC	€ 111,89	BLISTER DA 2000 PZ









# GESTIONE CODE E VIDEOCOMUNICAZIONE

IMMAGINE	DESCRIZIONE	CODICE E COLORE	PAG CAT	PREZZO	NOTE
	ETICHETTA ADESIVA "OFFERTA SPECIALE" PER	SLR4040F06	275	€ 1.132,20	CONF DA 20000 PZ
	SISTEMA RADIOFREQUENZA FREEZER D: 4 x 4 cm	SLR4040F06BL	FC	€ 135,86	BLISTER DA 2000 PZ
	ETICHETTA ADESIVA "OFFERTA SPECIALE" PER	SLR404006	275	€ 932,42	CONF DA 20000 PZ
	SISTEMA RADIOFREQUENZA NO FREEZER D: 4 x 4 cm	SLR404006BL	FC	€ 111,89	BLISTER DA 2000 PZ
	ETICHETTA ADESIVA "CONFEZIONE FAMIGLIA" PER	SLR4040F21	275	€ 1.032,30	CONF DA 20000 PZ
	SISTEMA RADIOFREQUENZA FREEZER D: 4 x 4 cm	SLR4040F21BL	FC	€ 123,88	BLISTER DA 2000 PZ
	ETICHETTA ADESIVA "CONSERVARE IN FRIGO" PER	SLR4040F88-S	275	€ 1.032,30	CONF DA 20000 PZ
	SISTEMA RADIOFREQUENZA FREEZER D: 4 x 4 cm	SLR4040F88-SBL	FC	€ 123,88	BLISTER DA 2000 PZ
	ETICHETTA ADESIVA NERA PER SISTEMA	SLR404002	275	€ 932,40	CONF DA 20000 PZ
	RADIOFREQUENZA D: 4 x 4 cm	SLR404002BL	FC	€ 111,89	BLISTER DA 2000 PZ
	ETICHETTA ADESIVA BIANCA PER SISTEMA	SLR4040F01	275	€ 999,00	CONF DA 20000 PZ
	RADIOFREQUENZA FREEZER D: 4 x 4 cm	SLR4040F01BL	FC	€ 119,88	BLISTER DA 2000 PZ
	ETICHETTA ADESIVA NERA PER SISTEMA	SLR502302	275	€ 1.132,20	CONF DA 20000 PZ
	RADIOFREQUENZA D: 5 x 2,3 cm	SLR502302BL	FC	€ 135,86	BLISTER DA 2000 PZ



# GESTIONE CODE E VIDEOCOMUNICAZIONE

IMMAGINE	DESCRIZIONE	CODICE E COLORE	PAG CAT	PREZZO	NOTE
	ETICHETTA ADESIVA "PRODOTTO ITALIANO" PER SISTEMA RADIOFREQUENZA D: Ø 4 cm	SLRD4007	275	€ 932,40	CONF DA 20000 PZ
		SLRD4007BL	FC	€ 111,89	BLISTER DA 2000 PZ
	ETICHETTA ADESIVA HQ PER SISTEMA RADIOFREQUENZA FALSO BARCODE Ø 3,3 cm	SLRD3300	276	€ 932,40	CONF DA 20000 PZ
		SLRD3300BL	FC	€ 111,89	BLISTER DA 2000 PZ
	ETICHETTA ADESIVA HQ PER SISTEMA RADIOFREQUENZA BIANCA NEUTRA Ø 3,3 cm	SLRD3301	276	€ 932,40	CONF DA 20000 PZ
		SLRD3302BL	FC	€ 111,89	BLISTER DA 2000 PZ
	ETICHETTA ADESIVA HQ PER SISTEMA RADIOFREQUENZA FALSO BARCODE Ø 4 cm	SLRD4000	276	€ 932,40	CONF DA 20000 PZ
		SLRD4000BL	FC	€ 111,89	BLISTER DA 2000 PZ
	ETICHETTA ADESIVA HQ PER SISTEMA RADIOFREQUENZA BIANCA NEUTRA Ø 4 cm	SLRD4001	276	€ 932,40	CONF DA 20000 PZ
		SLRD4001BL	FC	€ 111,89	BLISTER DA 2000 PZ
	ETICHETTA ADESIVA "OFFERTA SPECIALE" PER SISTEMA RADIOFREQUENZA FREEZER Ø 4 cm	SLRD40F06	276	€ 1.132,20	CONF DA 20000 PZ
		SLRD40F06BL	FC	€ 135,86	BLISTER DA 2000 PZ
	ETICHETTA ADESIVA "OFFERTA SPECIALE" PER SISTEMA RADIOFREQUENZA NO FREEZER Ø 4 cm	SLRD4006	276	€ 932,40	CONF DA 20000 PZ
		SLRD4006BL	FC	€ 111,89	BLISTER DA 2000 PZ
	ETICHETTA ADESIVA TRASPARENTE HQ D: 1,5 x 5,3 cm	SLR155103	276	€ 799,20	CONF DA 20000 PZ
		SLR155103BL	FC	€ 95,90	BLISTER DA 2000 PZ

# GESTIONE CODE E VIDEOCOMUNICAZIONE

IMMAGINE	DESCRIZIONE	CODICE E COLORE	PAG CAT	PREZZO	NOTE
	PLACCA PROTETTIVA MINI NERA SUPER PER SISTEMA RADIOFREQUENZA D: 4,2 x 4,6 cm	HTR8001MIN46	277	€ 228,48	CONF DA 1000 PZ
	PLACCA PROTETTIVA MINI NERA SUPER PER SISTEMA RADIOFREQUENZA D: 4,3 x 5,2 cm	HTR3005MIN52	277	€ 262,08	CONF DA 1000 PZ
	PLACCA PROTETTIVA R50 SUPER NERA PER SISTEMA RADIOFREQUENZA	HTR8010R50BLK	277	€ 336,00	CONF DA 1000 PZ
	PLACCA PROTETTIVA R50 SUPER GRIGIA PER SISTEMA RADIOFREQUENZA	HTR8010R50	277	€ 399,60	CONF DA 1000 PZ
	PLACCA PROTETTIVA TE4 SUPER NERA Ø 4 cm PER SISTEMA RADIOFREQUENZA	HTR8026TEBLK	277	€ 399,60	CONF DA 1000 PZ
	PLACCA PROTETTIVA TE4 SUPER GRIGIA Ø 4 cm PER SISTEMA RADIOFREQUENZA	HTR8026TE	277	€ 399,60	CONF DA 1000 PZ
	PLACCA PROTETTIVA TE4 SUPER NERA Ø 5 cm PER SISTEMA RADIOFREQUENZA	HTR8029TEBLK	277	€ 399,60	CONF DA 1000 PZ
	PLACCA PROTETTIVA TE4 SUPER GRIGIA Ø 5 cm PER SISTEMA RADIOFREQUENZA	HTR8029TE	277	€ 399,60	CONF DA 1000 PZ
	PLACCA PROTETTIVA RAGNO GRANDE PER SISTEMA RADIOFREQUENZA D: Ø 7 cm	HTR2701SWB2	277	€ 1.598,40	CONF DA 100 PZ

# GESTIONE CODE E VIDEOCOMUNICAZIONE

IMMAGINE	DESCRIZIONE	CODICE E COLORE	PAG CAT	PREZZO	NOTE
	PLACCA PROTETTIVA RAGNO PICCOLA PER SISTEMA RADIOFREQUENZA D: Ø 5,5 cm	HTR2501SWB2	277	€ 1.998,40	CONF DA 250 PZ
	COLLARINO PROTETTIVO PER BOTTIGLIAPER SISTEMA RADIOFREQUENZA D: Ø 5 cm	HTR8301BOTL5	277	€ 499,50	CONF DA 500 PZ
	LACCETTO ACCIAIO RICOPERTO PER SISTEMA RADIOFREQUENZA L: 17 cm	LYU17ACP	277	€ 2.164,50	CONF DA 10000 PZ
		LYU17ACPBL	277	€ 43,29	CONF DA 100 PZ
	LACCETTO ACCIAIO RICOPERTO PER SISTEMA	LYU3001BCP	277	€ 2.164,50	CONF DA 10000 PZ
	RADIOFREQUENZA L: 30 cm	LYU3001BCPBL	277	€ 43,29	CONF DA 100 PZ



# PREZZATRICI, ETICHETTE E ROTOLI

IMMAGINE	DESCRIZIONE	CODICE E COLORE	PAG CAT	PREZZO	NOTE
 <p>*48 g/m2</p>	ROTOLO TERMICO OMOLOGATO REG. CASSA D: 57 x 25 x 12 mm	RTTM57251248	281	SP IN FUNZIONE DELLA QUANTITÀ	RS: 50 SB:100 RB: 5000
	ROTOLO TERMICO OMOLOGATO REG. CASSA D: 57 x 27 x 12 mm	RTTM57271248	281	SP IN FUNZIONE DELLA QUANTITÀ	RS: 50 SB:100 RB: 5000
	ROTOLO TERMICO OMOLOGATO REG. CASSA D: 57 x 30 x 12 mm	RTTM57301248	281	SP IN FUNZIONE DELLA QUANTITÀ	RS: 50 SB:100 RB: 5000
	ROTOLO TERMICO OMOLOGATO REG. CASSA D: 57 x 32 x 12 mm	RTTM57321248	281	SP IN FUNZIONE DELLA QUANTITÀ	RS: 50 SB:100 RB: 5000
	ROTOLO TERMICO OMOLOGATO REG. CASSA D: 57 x 35 x 12 mm	RTTM57351248	281	SP IN FUNZIONE DELLA QUANTITÀ	RS: 50 SB:100 RB: 5000
	ROTOLO TERMICO OMOLOGATO REG. CASSA D: 57 x 90 x 12 mm	RTTM57901248	281	SP IN FUNZIONE DELLA QUANTITÀ	RS: 50 SB:100 RB: 5001
 <p>*55 g/m2</p>	ROTOLO TERMICO OMOLOGATO REG. CASSA D: 57 x 25 x 12 mm	RTTM57251255	281	SP IN FUNZIONE DELLA QUANTITÀ	RS: 50 SB:100 RB: 5000
	ROTOLO TERMICO OMOLOGATO REG. CASSA D: 57 x 27 x 12 mm	RTTM57271255	281	SP IN FUNZIONE DELLA QUANTITÀ	RS: 50 SB:100 RB: 5000
	ROTOLO TERMICO OMOLOGATO REG. CASSA D: 57 x 30 x 12 mm	RTTM57301255	281	SP IN FUNZIONE DELLA QUANTITÀ	RS: 50 SB:100 RB: 5000
	ROTOLO TERMICO OMOLOGATO REG. CASSA D: 57 x 32 x 12 mm	RTTM57321255	281	SP IN FUNZIONE DELLA QUANTITÀ	RS: 50 SB:100 RB: 5000
	ROTOLO TERMICO OMOLOGATO REG. CASSA D: 57 x 35 x 12 mm	RTTM57351255	281	SP IN FUNZIONE DELLA QUANTITÀ	RS: 50 SB:100 RB: 5000
 <p>*48 g/m2</p>	ROTOLO TERMICO OMOLOGATO REG. CASSA D: 80 x 70 x 12 mm	RTTM80701248	281	SP IN FUNZIONE DELLA QUANTITÀ	RS: 30 SB: 80 RB: 2400
	ROTOLO TERMICO OMOLOGATO REG. CASSA D: 80 x 72 x 12 mm	RTTM80721248	281	SP IN FUNZIONE DELLA QUANTITÀ	RS: 30 SB: 80 RB: 2400
	ROTOLO TERMICO OMOLOGATO REG. CASSA D: 80 x 75 x 12 mm	RTTM80751248	281	SP IN FUNZIONE DELLA QUANTITÀ	RS: 50 SB: 48 RB: 2400
	ROTOLO TERMICO OMOLOGATO REG. CASSA D: 80 x 80 x 12 mm	RTTM80801248	281	SP IN FUNZIONE DELLA QUANTITÀ	RS: 30/50 SB: 80/48 RB: 2400
	ROTOLO TERMICO OMOLOGATO REG. CASSA D: 80 x 90 x 12 mm	RTTM80901248	281	SP IN FUNZIONE DELLA QUANTITÀ	RS: 30 SB: 48 RB: 2400
 <p>*55 g/m2</p>	ROTOLO TERMICO OMOLOGATO REG. CASSA D: 80 x 70 x 12 mm	RTTM80561275	281	SP IN FUNZIONE DELLA QUANTITÀ	RS: 30 SB: 80 RB: 2400
	ROTOLO TERMICO OMOLOGATO REG. CASSA D: 80 x 72 x 12 mm	RTTM80591275	281	SP IN FUNZIONE DELLA QUANTITÀ	RS: 30 SB: 80 RB: 2400
	ROTOLO TERMICO OMOLOGATO REG. CASSA D: 80 x 75 x 12 mm	RTTM80621275	281	SP IN FUNZIONE DELLA QUANTITÀ	RS: 58 SB: 48 RB: 2400



# PREZZATRICI, ETICHETTE E ROTOLI

IMMAGINE	DESCRIZIONE	CODICE E COLORE	PAG CAT	PREZZO	NOTE
 <p>*48 g/m2</p>	ROTOLO TERMICO POS D: 57 x 12 mm	RTTP57121201	282	SP IN FUNZIONE DELLA QUANTITÀ	RS:50 SB: 100 RB: 5000
	ROTOLO TERMICO POS D: 57 x 16 mm	RTTP57161201	282	SP IN FUNZIONE DELLA QUANTITÀ	RS:50 SB: 100 RB: 5000
	ROTOLO TERMICO POS D: 57 x 18 mm	RTTP57181201	282	SP IN FUNZIONE DELLA QUANTITÀ	RS: 50/100 SB: 100 RB: 5K/10K
	ROTOLO TERMICO POS D: 57 x 20 mm	RTTP57201201	282	SP IN FUNZIONE DELLA QUANTITÀ	RS: 50/100 SB: 100 RB: 5K/10K
 <p>*48 g/m2</p>	ROTOLO TERMICO POS SENZA ANIMA D: 57 mm x 8 Mt	RTSAP57848	282	SP IN FUNZIONE DELLA QUANTITÀ	
	ROTOLO TERMICO POS SENZA ANIMA D: 57 mm x 13 Mt	RTSAP51348	282	SP IN FUNZIONE DELLA QUANTITÀ	
	ROTOLO TERMICO NON ADESIVO D: 57 x 135 x 25 mm	ETBT057135NP01	283	SP IN FUNZIONE DELLA QUANTITÀ	RS: 20 SB: 60 RB: 1200
	ROTOLO TERMICO NON ADESIVO BILANCE D: 57 x 30 x 12 mm	ETBT057030NP01	283	SP IN FUNZIONE DELLA QUANTITÀ	RS: 50 SB:100 RB: 5000
	ROTOLO TERMICO NON ADESIVO BILANCE D: 60 x 30 x 12 mm	ETBT060030NP01	283	SP IN FUNZIONE DELLA QUANTITÀ	RS: 50 SB:100 RB: 5000
	ROTOLO TERMICO NON ADESIVO D: 60 x 90 x 25 mm	ETBT060090NP01	283	SP IN FUNZIONE DELLA QUANTITÀ	RS: 30 SB:40 RB: 1200
	ROTOLO TERMICO NON ADESIVO D: 60 x 150 x 12 mm	ETBT060150NP01	283	SP IN FUNZIONE DELLA QUANTITÀ	RS: 20 SB: 60 RB: 1200
	ROTOLO TERMICO NON ADESIVO BILANCE D: 62 x 15 x 12 mm	ETBT062150NP01	283	SP IN FUNZIONE DELLA QUANTITÀ	RS: 20 SB: 60 RB: 1200
	ROTOLO TERMICO NON ADESIVO BILANCE D: 62 x 30 x 12 mm	ETBT062030NP01	283	SP IN FUNZIONE DELLA QUANTITÀ	RS:50 SB: 100 RB: 5000
	ROTOLO TERMICO NON ADESIVO D: 62 x 90 X 25,4 mm	ETBT062090NP01	283	SP IN FUNZIONE DELLA QUANTITÀ	RS: 30 SB: 50 RB: 1500

# PREZZATRICI, ETICHETTE E ROTOLI





IMMAGINE	DESCRIZIONE	CODICE E COLORE	PAG CAT	PREZZO	NOTE
	ROTOLO BILANCIA TERMICO ADESIVO D: 57 x 36 x 25/40 mm	RTTA57362501	283	SP IN FUNZIONE DELLA QUANTITÀ	RS: 50 SB: 50 RB:2500
	ROTOLO BILANCIA TERMICO ADESIVO D: 57 x 40 x 25/40 mm	RTTA57402501	283	SP IN FUNZIONE DELLA QUANTITÀ	RS: 50 SB: 50 RB:2500
	ROTOLO BILANCIA TERMICO ADESIVO D: 60 x 36 x 25/40 mm	RTTA60362501	283	SP IN FUNZIONE DELLA QUANTITÀ	RS: 50 SB: 50 RB:2500
	ROTOLO BILANCIA TERMICO ADESIVO D: 60 x 40 x 25/40 mm	RTTA60402501	283	SP IN FUNZIONE DELLA QUANTITÀ	RS: 30 SB: 100 RB: 3000
	ROTOLO BILANCIA TERMICO ADESIVO D: 62 x 38 x 25 mm	RTTA62382501	283	SP IN FUNZIONE DELLA QUANTITÀ	RS: 30 SB: 100 RB: 3000
	LINERLESS IN CARTA TERMICA CON ADESIVO PERMANENTE D: 56,5 x 20 x 12,7 mm	TLL565020P	285	SP IN FUNZIONE DELLA QUANTITÀ	RS: 60 SB: 72 RB: 4320
	LINERLESS IN CARTA TERMICA CON ADESIVO PERMANENTE D: 57,8 x 65 x4 mm	TLL578065P	285	SP IN FUNZIONE DELLA QUANTITÀ	RS: 50 SB: 100 RB: 5000
	LINERLESS IN CARTA TERMICA CON ADESIVO PERMANENTE D: 60 x 30 x 12 mm	TLL600030P	285	SP IN FUNZIONE DELLA QUANTITÀ	RS: 50 SB: 100 RB: 5000
	LINERLESS IN CARTA TERMICA CON ADESIVO PERMANENTE D: 60 x 25 mm	TLL600090P	285	SP IN FUNZIONE DELLA QUANTITÀ	RS: 30 SB: 40 RB: 1200
	LINERLESS IN CARTA TERMICA CON ADESIVO PERMANENTE D: 62 x 150 x 12,7 mm	TLL620150P	285	SP IN FUNZIONE DELLA QUANTITÀ	RS: 20 SB: 60 RB: 1200

# PREZZATRICI, ETICHETTE E ROTOLI

IMMAGINE	DESCRIZIONE	CODICE E COLORE	PAG CAT	PREZZO	NOTE
	LINERLESS IN CARTA TERMICA CON ADESIVO REMOVIBILE D: 56,5 x 20 x 12,7 mm	TLL565020R	285	SP IN FUNZIONE DELLA QUANTITÀ	RS: 60 SB: 72 RB: 4320
	LINERLESS IN CARTA TERMICA CON ADESIVO REMOVIBILE D: 57,8 x 65 x 4 mm	TLL578065R	285	SP IN FUNZIONE DELLA QUANTITÀ	RS: 50 SB: 100 RB: 5000
	LINERLESS IN CARTA TERMICA CON ADESIVO REMOVIBILE D: 60 x 30 x 12 mm	TLL600030R	285	SP IN FUNZIONE DELLA QUANTITÀ	RS: 50 SB: 100 RB: 5000
	LINERLESS IN CARTA TERMICA CON ADESIVO REMOVIBILE D: 60 x 25 mm	TLL600090R	285	SP IN FUNZIONE DELLA QUANTITÀ	RS: 30 SB: 40 RB: 1200
	LINERLESS IN CARTA TERMICA CON DEEP FREEZE D: 56,5 x 20 x 12,7 mm	TLL563020F	285	SP IN FUNZIONE DELLA QUANTITÀ	RS: 60 SB: 72 RB: 4320
	ROTOLO ETICHETTE ADESIVE TERMICHE AN. 40 1000 ET/RT PER BILANCE BIZERBA E METTLER TOLEDO D: 58 x 43 mm	ETBT058043NP01	289	SP IN FUNZIONE DELLA QUANTITÀ	RS: 30 SB: 36 RB: 1080
	ROTOLO ETICHETTE ADESIVE TERMICHE AN. 40 750 ET/RT PER BILANCE BIZERBA E METTLER TOLEDO D: 58 x 53 mm	ETBT058053NP01	289	SP IN FUNZIONE DELLA QUANTITÀ	RS: 30 SB: 36 RB: 1080
	ROTOLO ETICHETTE ADESIVE TERMICHE AN. 40 750 ET/RT PER BILANCE BIZERBA E METTLER TOLEDO D: 58 x 60 mm	ETBT058060NP01	289	SP IN FUNZIONE DELLA QUANTITÀ	RS: 30 SB: 36 RB: 1080
	ROTOLO ETICHETTE ADESIVE TERMICHE AN. 40 620 ET/RT PER BILANCE BIZERBA E METTLER TOLEDO D: 58 x 74 mm	ETBT058074NP01	289	SP IN FUNZIONE DELLA QUANTITÀ	RS: 30 SB: 36 RB: 1080
	ROTOLO ETICHETTE ADESIVE TERMICHE AN. 76 2500 ET/RT PER BILANCE BIZERBA E METTLER TOLEDO D: 58 x 74 mm	EART58747601	289	SP IN FUNZIONE DELLA QUANTITÀ	RS: 4 SB: 36 RB: 144







# PREZZATRICI, ETICHETTE E ROTOLI

IMMAGINE	DESCRIZIONE	CODICE E COLORE	PAG CAT	PREZZO	NOTE
	ROTOLO ETICHETTE ADESIVE CON FORO INTERNO 4 CM PER BILANCE BERKEL D: 40 x 72 mm	ETBT040072NP01	289	SP IN FUNZIONE DELLA QUANTITÀ	RS: 30 SB: 36 RB: 1080
	ROTOLO ETICHETTE ADESIVE CON FORO INTERNO 4 CM PER BILANCE BERKEL D: 47 x 61 mm	ETBT047061NP01	289	SP IN FUNZIONE DELLA QUANTITÀ	RS: 30 SB: 36 RB: 1080
	ROTOLO ETICHETTE ADESIVE CON FORO INTERNO 4 CM PER BILANCE BERKEL D: 47x 81 mm	ETBT047081NP01	289	SP IN FUNZIONE DELLA QUANTITÀ	RS: 30 SB: 36 RB: 1080
	ROTOLO ETICHETTE ADESIVE CON FORO INTERNO 2,5 CM PER BILANCE BERKEL D: 61 x 55 mm	ETBT061055NP01	289	SP IN FUNZIONE DELLA QUANTITÀ	RS: 30 SB: 36 RB: 144
	ROTOLO ETICHETTE ADESIVE CON FORO INTERNO 2,5 CM PER BILANCE OMEGA D: 60 x 45 mm	ETBT060045NP01	289	SP IN FUNZIONE DELLA QUANTITÀ	RS: 30 SB: 36 RB: 1080
	ROTOLO ETICHETTE ADESIVE CON FORO INTERNO 4 CM PER BILANCE OMEGA D: 60 x 75 mm	ETBT060075NP01	289	SP IN FUNZIONE DELLA QUANTITÀ	RS: 30 SB: 36 RB: 1080
	ETICHETTE PROMOZIONALI "-15% PREZZO IN ETICHETTA GIÀ SCONTATO" D: Ø 4 cm	PEPRRND001	CAT 2020	SP IN FUNZIONE DELLA QUANTITÀ	ROTOLI DA 1000 PZ CARTONI DA 50 ROTOLI
	ETICHETTE PROMOZIONALI "-25% PREZZO IN ETICHETTA GIÀ SCONTATO" D: Ø 4 cm	PEPRRND002	CAT 2020	SP IN FUNZIONE DELLA QUANTITÀ	ROTOLI DA 1000 PZ CARTONI DA 50 ROTOLI

# PREZZATRICI, ETICHETTE E ROTOLI

IMMAGINE	DESCRIZIONE	CODICE E COLORE	PAG CAT	PREZZO	NOTE
	ETICHETTE PROMOZIONALI "-30% PREZZO IN ETICHETTA GIÀ SCONTATO" D: Ø 4 cm	PEPRRND003	CAT 2020	SP IN FUNZIONE DELLA QUANTITÀ	ROTOLI DA 1000 PZ CARTONI DA 50 ROTOLI
	ETICHETTE PROMOZIONALI "-35% PREZZO IN ETICHETTA GIÀ SCONTATO" D: Ø 4 cm	PEPRRND004	CAT 2020	SP IN FUNZIONE DELLA QUANTITÀ	ROTOLI DA 1000 PZ CARTONI DA 50 ROTOLI
	ETICHETTE PROMOZIONALI "-45% PREZZO IN ETICHETTA GIÀ SCONTATO" D: Ø 4 cm	PEPRRND005	CAT 2020	SP IN FUNZIONE DELLA QUANTITÀ	ROTOLI DA 1000 PZ CARTONI DA 50 ROTOLI
	ETICHETTE PROMOZIONALI "SCONTO 20 % ALLE CASSE" D: Ø 3,6 cm	PEPRRND006	290	SP IN FUNZIONE DELLA QUANTITÀ	ROTOLI DA 1000 PZ CARTONI DA 50 ROTOLI
	ETICHETTE PROMOZIONALI "SCONTO 30 % ALLE CASSE" D: Ø 3,6 cm	PEPRRND007	CAT 2020	SP IN FUNZIONE DELLA QUANTITÀ	ROTOLI DA 1000 PZ CARTONI DA 50 ROTOLI
	ETICHETTE PROMOZIONALI "SCONTO 50 % ALLE CASSE" D: Ø 3,6 cm	PEPRRND008	CAT 2020	SP IN FUNZIONE DELLA QUANTITÀ	ROTOLI DA 1000 PZ CARTONI DA 50 ROTOLI

# PREZZATRICI, ETICHETTE E ROTOLI

IMMAGINE	DESCRIZIONE	CODICE E COLORE	PAG CAT	PREZZO	NOTE
	ETICHETTE PROMOZIONALI "SCONTO 30% ALLA CASSA" D: Ø 4 cm	PEPRRND009	CAT 2020	SP IN FUNZIONE DELLA QUANTITÀ	ROTOLI DA 1000 PZ CARTONI DA 50 ROTOLI
	ETICHETTE PROMOZIONALI "SCONTO 50% ALLA CASSA" D: Ø 4 cm	PEPRRND010	CAT 2020	SP IN FUNZIONE DELLA QUANTITÀ	ROTOLI DA 1000 PZ CARTONI DA 50 ROTOLI
	ETICHETTE PROMOZIONALI "PROMOZIONE" D: Ø 4 cm	PEPRRND011	290	SP IN FUNZIONE DELLA QUANTITÀ	ROTOLI DA 1000 PZ CARTONI DA 50 ROTOLI
	ETICHETTE PROMOZIONALI "OFFERTA SPECIALE" D: Ø 4 cm	PEPRRND012	290	SP IN FUNZIONE DELLA QUANTITÀ	ROTOLI DA 1000 PZ CARTONI DA 50 ROTOLI
	ETICHETTE PROMOZIONALI "NOVITÀ" D: Ø 5 cm	PEPRRND013	CAT 2020	SP IN FUNZIONE DELLA QUANTITÀ	ROTOLI DA 1000 PZ CARTONI DA 50 ROTOLI
	ETICHETTE PROMOZIONALI "ARGENTINA" D: Ø 4 cm	PEPRRND014	CAT 2020	SP IN FUNZIONE DELLA QUANTITÀ	ROTOLI DA 1000 PZ CARTONI DA 50 ROTOLI

# PREZZATRICI, ETICHETTE E ROTOLI

IMMAGINE	DESCRIZIONE	CODICE E COLORE	PAG CAT	PREZZO	NOTE
	ETICHETTE PROMOZIONALI "SCONTO 10%" D: 6 x 3,4 cm	PEPROVL001	CAT 2020	SP IN FUNZIONE DELLA QUANTITÀ	ROTOLE DA 1000 PZ CARTONI DA 50 ROTOLE
	ETICHETTE PROMOZIONALI "SCONTO 30 %" D: 6 x 3,4 cm	PEPROVL002	CAT 2020	SP IN FUNZIONE DELLA QUANTITÀ	ROTOLE DA 1000 PZ CARTONI DA 50 ROTOLE
	ETICHETTE PROMOZIONALI "SCONTO 20 % ALLA CASSA " D: 4 x 4 cm	PEPRSQR001	CAT 2020	SP IN FUNZIONE DELLA QUANTITÀ	ROTOLE DA 1000 PZ CARTONI DA 50 ROTOLE
	ETICHETTE PROMOZIONALI "SCONTO 30 % ALLA CASSA " D: 4 x 4 cm	PEPRSQR002	CAT 2020	SP IN FUNZIONE DELLA QUANTITÀ	ROTOLE DA 1000 PZ CARTONI DA 50 ROTOLE
	ETICHETTE PROMOZIONALI "50% SCONTO ALLE CASSE" D: 4 x 4 cm	PEPRSQR003	CAT 2020	SP IN FUNZIONE DELLA QUANTITÀ	ROTOLE DA 1000 PZ CARTONI DA 50 ROTOLE
	ETICHETTE PROMOZIONALI "SCONTO 50% ALLA CASSA" D: 4 x 4 cm	PEPRSQR004	290	SP IN FUNZIONE DELLA QUANTITÀ	ROTOLE DA 1000 PZ CARTONI DA 50 ROTOLE

# PREZZATRICI, ETICHETTE E ROTOLI

IMMAGINE	DESCRIZIONE	CODICE E COLORE	PAG CAT	PREZZO	NOTE
	ETICHETTE PROMOZIONALI "CARNE ITALIANA" D: Ø 4 cm	PEPRSQR005	CAT 2020	SP IN FUNZIONE DELLA QUANTITÀ	ROTOLE DA 1000 PZ CARTONI DA 50 ROTOLE
	ETICHETTE PROMOZIONALI "20% SCONTO ALLA CASSA" D: 5 x 3 cm	PEPRRCT001	CAT 2020	SP IN FUNZIONE DELLA QUANTITÀ	ROTOLE DA 1000 PZ CARTONI DA 50 ROTOLE
	ETICHETTE PROMOZIONALI "SCONTO 50%" D: 5 x 2,5 cm	PEPRRCT002	CAT 2020	SP IN FUNZIONE DELLA QUANTITÀ	ROTOLE DA 1000 PZ CARTONI DA 50 ROTOLE
	ETICHETTE PROMOZIONALI "CARNE IRLANDESE" D: 5 x 3 cm	PEPRRCT003	CAT 2020	SP IN FUNZIONE DELLA QUANTITÀ	ROTOLE DA 1000 PZ CARTONI DA 50 ROTOLE
	ETICHETTE PROMOZIONALI "CHIANINA LA RAZZA BOVINA NOBILE E PREGIATA" D: 5 x 3 cm	PEPRRCT004	CAT 2020	SP IN FUNZIONE DELLA QUANTITÀ	ROTOLE DA 1000 PZ CARTONI DA 50 ROTOLE
	ETICHETTE PROMOZIONALI "CONFEZIONE FAMIGLIA" D: 5 x 3 cm	PEPRRCT005	CAT 2020	SP IN FUNZIONE DELLA QUANTITÀ	ROTOLE DA 1000 PZ CARTONI DA 50 ROTOLE

# PREZZATRICI, ETICHETTE E ROTOLI

IMMAGINE	DESCRIZIONE	CODICE E COLORE	PAG CAT	PREZZO	NOTE
	ETICHETTE PROMOZIONALI "FORMATO CONVENIENZA" D: 5 x 3 cm	PEPRRCT006	CAT 2020	SP IN FUNZIONE DELLA QUANTITÀ	ROTOLE DA 1000 PZ CARTONI DA 50 ROTOLE
	ETICHETTE PROMOZIONALI "CONFEZIONE RISPARMIO" D: 5 x 3 cm	PEPRRCT007	CAT 2020	SP IN FUNZIONE DELLA QUANTITÀ	ROTOLE DA 1000 PZ CARTONI DA 50 ROTOLE
	ETICHETTE PROMOZIONALI "PREPARATO DA NOI" D: 5 x 3cm	PEPRRCT008	CAT 2020	SP IN FUNZIONE DELLA QUANTITÀ	ROTOLE DA 1000 PZ CARTONI DA 50 ROTOLE
	ETICHETTE PROMOZIONALI "CARNE DI SCOTTONA" D: 5 x 3cm	PEPRRCT009	CAT 2020	SP IN FUNZIONE DELLA QUANTITÀ	ROTOLE DA 1000 PZ CARTONI DA 50 ROTOLE
	APPLICATORE ELETTRONICO DI ETICHETTE DYNAMIC (MAX 70 mm)	PRDELD7010	292	€ 233,10	
	ALIMENTATORE PER APPLICATORE ELETTRONICO	PRDEAL7005	292	SP	

# PREZZATRICI, ETICHETTE E ROTOLI

IMMAGINE	DESCRIZIONE	CODICE E COLORE	PAG CAT	PREZZO	NOTE
	CARICA BATTERIA PER APPLICATORE ELETTRONICO	PRDEBC7005	292	€ 60,00	
	BATTERIA SUPPLEMENTARE	PRDEBT7005	292	€ 29,00	
	APPLICATORE MANUALE MD 60 LARGHEZZA ETICHETTE DA 2 A 6 cm	PRDMMD6005	292	€ 99,90	
	PREZZATRICE SERIE OPEN 1- 2 LINEE FORMATO ETICHETTE: 18 x 12, 21 x 12, 22 x 12, 22 x 16, 26 x 12, 26 x 16, 26 X 19	CUSTOM	294	SP	
	PREZZATRICE SERIE BLITZ 1- 2 LINEE FORMATO ETICHETTE: 18 x 12, 21 x 12, 22 x 12, 22 x 16, 26 x 12, 26 x 16, 26 X 19	CUSTOM	294	SP	
	PREZZATRICE SERIE EVO 1- 2 LINEE FORMATO ETICHETTE: 18 x 12, 21 x 12, 22 x 12, 22 x 16, 26 x 12, 26 x 16, 26 X 19	CUSTOM	294	SP	

# PREZZATRICI, ETICHETTE E ROTOLI



IMMAGINE	DESCRIZIONE	CODICE E COLORE	PAG CAT	PREZZO	NOTE
	PREZZATRICE SERIE LARGE OPEN 1- 2-3 LINEE FORMATO ETICHETTE: 37 x 19, 32 x 19, OVALE (BASE 37 x 28), BOLLINO 35 mm, (BASE 37 x 36), 29 x 28, 37 x 28, 30 x 36, 37 x 36	CUSTOM	294	SP	
	PREZZATRICE SERIE LARGE BLITZ 1- 2-3 LINEE FORMATO ETICHETTE: 37 x 19, 32 x 19, OVALE (BASE 37 x 28), BOLLINO 35 mm, (BASE 37 x 36), 29 x 28, 37 x 28, 30 x 36, 37 x 36	CUSTOM	294	SP	
	PREZZATRICE SERIE LARGE EVO 1- 2-3 LINEE FORMATO ETICHETTE: 37 x 19, 32 x 19, OVALE (BASE 37 x 28), BOLLINO 35 mm, (BASE 37 x 36), 29 x 28, 37 x 28, 30 x 36, 37 x 36	CUSTOM	294	SP	
	PREZZATRICE SERIE JOLLY 1- 2 LINEE FORMATO ETICHETTE: 18 x 10, 20 x 17, 24 x 15, 21 x 12, 22 x 12, 22 x 16, 26 x 12, 26 x 16, 26 X 19	CUSTOM	295	SP	
	PREZZATRICE SERIE SWING 1- 2 LINEE FORMATO ETICHETTE: 18 x 12, 21 x 12, 22 x 12, 22 x 16, 26 x 12, 26 x 16, 26 X 19	CUSTOM	295	SP	



# PREZZATRICI, ETICHETTE E ROTOLI

IMMAGINE	DESCRIZIONE	CODICE E COLORE	PAG CAT	PREZZO	NOTE
	PREZZATRICE SERIE SKY 1- 2 LINEE FORMATO ETICHETTE: 18 x 12, 21 x 12, 22 x 12, 22 x 16, 26 x 12, 26 x 16, 26 X 19	CUSTOM	295	SP	
	PREZZATRICE ECONOMICA SERIE SWING ETICHETTE: 2,6 x 1,2 cm 1 LINEA 6 CARATTERI	PRSW06L112	CAT 2020	€ 38,42	
	PREZZATRICE ECONOMICA SERIE SWING ETICHETTE: 2,6 x 1,2 cm 1 LINEA 8 CARATTERI	PRSW08L112	CAT 2020	€ 38,42	
	PREZZATRICE ECONOMICA SERIE SWING ETICHETTE: 2,6 x 1,6 cm 2 LINEE 14 CARATTERI LINEA SUP. 8 CARATTERI LINEA INF. 6 CARATTERI	PRSW14L212	CAT 2020	€ 66,29	
	PREZZATRICE ECONOMICA SERIE SWING ETICHETTE: 2,6 x 1,6 cm 2 LINEE 16 CARATTERI LINEA SUP. 8 CARATTERI LINEA INF. 8 CARATTERI	PRSW16L212	CAT 2020	€ 66,29	
	PREZZATRICE ECONOMICA SERIE SWING ETICHETTE: 2,6 x 1,6 cm 2 LINEE 17 CARATTERI LINEA SUP. 10 CARATTERI LINEA INF. 7 CARATTERI	PRSW17L212	CAT 2020	€ 66,29	
	PREZZATRICE ECONOMICA SERIE SWING ETICHETTE: 2,6 x 1,6 cm 2 LINEE 20 CARATTERI LINEA SUP. 10 CARATTERI LINEA INF. 10 CARATTERI	PRSW20L212	CAT 2020	€ 66,29	

# PREZZATRICI, ETICHETTE E ROTOLI

IMMAGINE	DESCRIZIONE	CODICE E COLORE	PAG CAT	PREZZO	NOTE
	<p>PREZZATRICE PROFESSIONALE SERIE EVO SMALL ETICHETTE: 2,6 x 1,2 cm 1 LINEA 6 CARATTERI</p>	PREV06L105	CAT 2020	€ 140,00	
	<p>PREZZATRICE PROFESSIONALE SERIE EVO SMALL ETICHETTE: 2,6 x 1,2 cm 1 LINEA 10 CARATTERI</p>	PREV10L105	CAT 2020	€ 140,00	
	<p>PREZZATRICE PROFESSIONALE SERIE EVO SMALL ETICHETTE: 2,6 x 1,6 cm 2 LINEE 14 CARATTERI LINEA SUP. 8 CARATTERI LINEA INF. 6 CARATTERI</p>	PREV14L205	CAT 2020	€ 140,00	
	<p>PREZZATRICE PROFESSIONALE SERIE EVO PROMO 1 LINEA ETICHETTE OVALI E RETTANGOLARI: 3,7 x 2,8 cm</p>	PREVPRL110	CAT 2020	SP	
	<p>PREZZATRICE PROFESSIONALE SERIE EVO PROMO 1 LINEA ETICHETTE TONDE: Ø 3,5 cm</p>	PREVPTL110	CAT 2020	SP	

# PREZZATRICI, ETICHETTE E ROTOLI

IMMAGINE	DESCRIZIONE	CODICE E COLORE	PAG CAT	PREZZO	NOTE
	<p>PREZZATRICE PROFESSIONALE SERIE EVO BIG                      ETICHETTE: 2,9 x 2,8 cm                      2 LINEE 19 CARATTERI                      LINEA SUP. 12 CARATTERI (h: 0,45 cm)                      LINEA INF. 7 CARATTERI (h: 0,85 cm)</p>	PREV27M210	CAT 2020	€ 199,80	
	<p>PREZZATRICE PROFESSIONALE SERIE EVO BIG                      ETICHETTE: 2,9 x 2,8 cm                      3 LINEE 29 CARATTERI                      LINEA SUP. 11 CARATTERI (h: 0,3 cm)                      LINEA CEN. 11 CARATTERI (h: 0,45 cm)                      LINEA INF. 7 CARATTERI (h: 0,45 cm)</p>	PREVA17310	CAT 2020	SP	
	<p>PREZZATRICE PROFESSIONALE SERIE EVO BIG                      ETICHETTE: 2,9 x 2,8 cm                      3 LINEE                      LINEA SUP. DICITURE PROMOZIONALI (h: 0,3 cm)                      LINEA CEN. 7 CARATTERI NUMERICI (h: 0,45 cm)                      LINEA INF. 7 CARATTERI (h: 0,45 cm)</p>	PREVC77310	CAT 2020	SP	
	<p>PREZZATRICE PROFESSIONALE SERIE BLITZ MAXI                      ETICHETTE 2,6 x 1,6 cm                      1 LINEA 6 CARATTERI (h: 8 mm)</p>	PRBZ06L105	CAT 2020	SP	

# PREZZATRICI, ETICHETTE E ROTOLI

IMMAGINE	DESCRIZIONE	CODICE E COLORE	PAG CAT	PREZZO	NOTE
	<p>PREZZATRICE PROFESSIONALE SERIE BITZ 3 LINEE            ETICHETTE: 3,7 x 2,8 cm            LINEA SUP. 11 CARATTERI ALFANUMERICI (h: 0,3 cm)            LINEA CEN. DICITURA PROMOZIONALE (h: 0,45 cm)            LINEA INF. 7 CARATTERI NUMERICI (h: 0,45 cm)</p>	PRBZP1L305	CAT 2020	€ 236,00	
	<p>PREZZATRICE PROFESSIONALE SERIE BITZ 3 LINEE            ETICHETTE: 3,7 x 2,8 cm            LINEA SUP. 12 CARATTERI ALFANUMERICI (h: 0,3 cm)            LINEA CEN. 12 CARATTERI NUMERICI (h: 0,45 cm)            LINEA INF. 12 CARATTERI NUMERICI (h: 0,3/0,45 cm)</p>	PRBZP2L305	CAT 2020	SP	
	<p>PREZZATRICE PROFESSIONALE SERIE BITZ 3 LINEE            ETICHETTE: 3,7 x 2,8 cm            LINEA SUP. 14 CARATTERI ALFANUMERICI (h: 0,3 cm)            LINEA CEN. "DA CONS." + 5 CARATTERI NUMERICI (h: 0,45 cm)            LINEA INF. 7 CARATTERI NUMERICI (h: 0,45 cm)</p>	PRBZP3L305	CAT 2020	SP	



# PREZZATRICI, ETICHETTE E ROTOLI

IMMAGINE	DESCRIZIONE	CODICE E COLORE	PAG CAT	PREZZO	NOTE
 <p><b>SKY</b></p>	TAMPONI PER PREZZATRICI SKY	PRIRSK0105	295	SP	CONF DA 100 PZ
	TAMPONI PER PREZZATRICI SKY	PRIREV0105	295	SP	BLISTER 5 PZ
 <p><b>EVO</b></p>	TAMPONI PER PREZZATRICI EVO	PRBZP1L3	295	SP	CONF DA 100 PZ
	TAMPONI PER PREZZATRICI EVO	PRIREV0505	295	€ 9,90	BLISTER DA 5 PZ
 <p><b>OPEN 3 linee</b></p>	TAMPONI PER PREZZATRICI OPEN 3 LINEE	PRIRPN3405	295	SP	CONF DA 40 PZ
	TAMPONI PER PREZZATRICI OPEN 3 LINEE	PRIRPN3205	295	€ 4,51	BLISTER DA 2 PZ
 <p><b>OPEN</b></p>	TAMPONI PER PREZZATRICI OPEN	PRIROP0105	295	SP	CONF DA 100 PZ
	TAMPONI PER PREZZATRICI OPEN	PRIROP0505	295	€ 9,90	BLISTER DA 5 PZ
 <p><b>BLITZ</b></p>	TAMPONI PER PREZZATRICI BLITZ	PRIRBL0105	295	SP	CONF DA 100 PZ
	TAMPONI PER PREZZATRICI BLITZ	PRIRBL0505	295	€ 9,90	BLISTER DA 5 PZ
 <p><b>EVO 3 linee</b></p>	TAMPONI PER PREZZATRICI EVO 3 LINEE	PRIREV3405	295	SP	CONF DA 40 PZ
	TAMPONI PER PREZZATRICI EVO 3 LINEE	PRIREV3205	295	€ 4,51	BLISTER DA 2 PZ
 <p><b>SWING</b></p>	TAMPONI PER PREZZATRICI SWING	PRIRSW0105	295	SP	CONF DA 100 PZ
	TAMPONI PER PREZZATRICI SWING	PRIRSW0505	295	€ 9,90	BLISTER DA 5 PZ

# PREZZATRICI, ETICHETTE E ROTOLI

IMMAGINE	DESCRIZIONE	CODICE E COLORE	PAG CAT	PREZZO	NOTE
 <p><b>JOLLY</b></p>	TAMPONI PER PREZZATRICI JOLLY	PRIRJL0105	295	SP	CONF DA 100 PZ
	TAMPONI PER PREZZATRICI JOLLY	PRIRJL0505	295	€ 9,90	BLISTER DA 5 PZ
 <p><b>BLITZ 3 linee</b></p>	TAMPONI PER PREZZATRICI BLITZ 3 LINEE	PRIRBL3405	295	SP	CONF DA 40 PZ
	TAMPONI PER PREZZATRICI BLITZ 3 LINEE	PRIRBL3205	295	€ 4,51	BLISTER DA 2 PZ
 <p><b>MOTEX</b></p>	TAMPONI PER PREZZATRICI MOTEX	PRIRMX0105	295	SP	CONF DA 100 PZ
	TAMPONI PER PREZZATRICI MOTEX	PRIRMX0505	295	€ 9,90	BLISTER DA 5 PZ
 <p><b>PRIX</b></p>	TAMPONI PER PREZZATRICI PRIX	PRIRPX0105	295	SP	CONF DA 100 PZ
	TAMPONI PER PREZZATRICI PRIX	PRIRPX0505	295	SP	BLISTER DA 5 PZ
 <p><b>METO 3 linee</b></p>	TAMPONI PER PREZZATRICI METO 3 LINEE	PRIRME3405	295	SP	CONF DA 40 PZ
	TAMPONI PER PREZZATRICI METO 3 LINEE	PRIRME3205	295	SP	BLISTER DA 2 PZ
 <p><b>CONTACT</b></p>	TAMPONI PER PREZZATRICI CONTACT	PRIRCT0105	295	SP	CONF DA 100 PZ
	TAMPONI PER PREZZATRICI CONTACT	PRIRCT0505	295	SP	BLISTER DA 5 PZ
 <p><b>SMART</b></p>	TAMPONI PER PREZZATRICI SMART	PRIRSM0105	295	SP	CONF DA 100 PZ
	TAMPONI PER PREZZATRICI SMART	PRIRSM0505	295	SP	BLISTER DA 5 PZ

# PREZZATRICI, ETICHETTE E ROTOLI

IMMAGINE	DESCRIZIONE	CODICE E COLORE	PAG CAT	PREZZO	NOTE
 <p><b>TOVEL</b></p>	TAMPONI PER PREZZATRICI TOVEL	PRIRTV0105	295	SP	CONF DA 100 PZ
	TAMPONI PER PREZZATRICI TOVEL	PRIRTV0505	295	SP	BLISTER DA 5 PZ
 <p><b>METO</b></p>	TAMPONI PER PREZZATRICI METO	PRIRME0105	295	SP	CONF DA 100 PZ
	TAMPONI PER PREZZATRICI METO	PRIRME0505	295	SP	BLISTER DA 5 PZ
 <p><b>21X12</b></p>	ETICHETTA ADESIVA PER PREZZATRICE 21 x 12 mm PRESTAMPATA CON RIGHE ROSSE PERMANENTE	ETPR2112TP01	297	SP	ROTOLO DA 1000 PZ CARTONI DA 50 ROTOLO
	ETICHETTA ADESIVA PER PREZZATRICE 21 x 12 mm PRESTAMPATA CON RIGHE ROSSE REMOVIBILE	ETPR2112TR01	297	SP	ROTOLO DA 1000 PZ CARTONI DA 50 ROTOLO
	ETICHETTA ADESIVA PER PREZZATRICE 21 x 12 mm PRESTAMPATA CON RIGHE ROSSE SURGELATI	ETPR2112TS01	297	SP	ROTOLO DA 1000 PZ CARTONI DA 50 ROTOLO

# PREZZATRICI, ETICHETTE E ROTOLI

IMMAGINE	DESCRIZIONE	CODICE E COLORE	PAG CAT	PREZZO	NOTE
<div style="border: 1px solid black; padding: 10px; width: fit-content; margin: auto;"> <b>21X12</b> </div>	ETICHETTA ADESIVA PER PREZZATRICE 21 x 12 mm PERMANENTE COLORI STANDARD	ETPR2112CP01 ETPR2112CP03 ETPR2112CP06 ETPR2112CP07 ETPR2112CP09 ETPR2112CP13 ETPR2112CP14	297	SP	ROTOLO DA 1000 PZ CARTONI DA 50 ROTOLI
	ETICHETTA ADESIVA PER PREZZATRICE 21 x 12 mm PERMANENTE COLORI FLUO	ETPR2112FP50 ETPR2112FP51 ETPR2112FP52 ETPR2112FP53 ETPR2112FP54	297	SP	ROTOLO DA 1000 PZ CARTONI DA 50 ROTOLI
	ETICHETTA ADESIVA PER PREZZATRICE 21 x 12 mm REMOVIBILE COLORI STANDARD	ETPR2112CR01 ETPR2112CR03 ETPR2112CR06 ETPR2112CR07 ETPR2112CR09 ETPR2112CR13 ETPR2112CR14	297	SP	ROTOLO DA 1000 PZ CARTONI DA 50 ROTOLI
	ETICHETTA ADESIVA PER PREZZATRICE 21 x 12 mm REMOVIBILE COLORI FLUO	ETPR2112FR50 ETPR2112FR51 ETPR2112FR52 ETPR2112FR53 ETPR2112FR54	297	SP	ROTOLO DA 1000 PZ CARTONI DA 50 ROTOLI
	ETICHETTA ADESIVA PER PREZZATRICE 21 x 12 mm SURGELATI COLORI STANDARD	ETPR2112CS01 ETPR2112CS03 ETPR2112CS06 ETPR2112CS07 ETPR2112CS09 ETPR2112CS13 ETPR2112CS14	297	SP	ROTOLO DA 1000 PZ CARTONI DA 50 ROTOLI
	ETICHETTA ADESIVA PER PREZZATRICE 21 x 12 mm SURGELATI COLORI FLUO	ETPR2112FS50 ETPR2112FS51 ETPR2112FS52 ETPR2112FS53 ETPR2112FS54	297	SP	ROTOLO DA 1000 PZ CARTONI DA 50 ROTOLI



# PREZZATRICI, ETICHETTE E ROTOLI

IMMAGINE	DESCRIZIONE	CODICE E COLORE	PAG CAT	PREZZO	NOTE
	ETICHETTA ADESIVA PER PREZZATRICE 22 x 16 mm PERMANENTE COLORI STANDARD	ETPR2216CP01 ETPR2216CP03 ETPR2216CP06 ETPR2216CP07 ETPR2216CP09 ETPR2216CP13 ETPR2216CP14	297	SP	ROTOLO DA 1000 PZ CARTONI DA 42 ROTOLI
	ETICHETTA ADESIVA PER PREZZATRICE 22 x 16 mm PERMANENTE COLORI FLUO	ETPR2216FP50 ETPR2216FP51 ETPR2216FP52 ETPR2216FP53 ETPR2216FP54	297	SP	ROTOLO DA 1000 PZ CARTONI DA 42 ROTOLI
	ETICHETTA ADESIVA PER PREZZATRICE 22 x 16 mm REMOVIBILE COLORI STANDARD	ETPR2216CR01 ETPR2216CR03 ETPR2216CR06 ETPR2216CR07 ETPR2216CR09 ETPR2216CR13 ETPR2216CR14	297	SP	ROTOLO DA 1000 PZ CARTONI DA 42 ROTOLI
	ETICHETTA ADESIVA PER PREZZATRICE 22 x 16 mm REMOVIBILE COLORI FLUO	ETPR2216FR50 ETPR2216FR51 ETPR2216FR52 ETPR2216FR53 ETPR2216FR54	297	SP	ROTOLO DA 1000 PZ CARTONI DA 42 ROTOLI
	ETICHETTA ADESIVA PER PREZZATRICE 22 x 16 mm SURGELATI COLORI STANDARD	ETPR2216CS01 ETPR2216CS03 ETPR2216CS06 ETPR2216CS07 ETPR2216CS09 ETPR2216CS13 ETPR2216CS14	297	SP	ROTOLO DA 1000 PZ CARTONI DA 42 ROTOLI
	ETICHETTA ADESIVA PER PREZZATRICE 22 x 16 mm SURGELATI COLORI FLUO	ETPR2216FS50 ETPR2216FS51 ETPR2216FS52 ETPR2216FS53 ETPR2216FS54	297	SP	ROTOLO DA 1000 PZ CARTONI DA 42 ROTOLI

# PREZZATRICI, ETICHETTE E ROTOLI

IMMAGINE	DESCRIZIONE	CODICE E COLORE	PAG CAT	PREZZO	NOTE
<div style="border: 1px solid black; padding: 10px; width: fit-content; margin: auto;"> <b>26X12</b> </div>	ETICHETTA ADESIVA PER PREZZATRICE 26 x 12 mm PERMANENTE COLORI STANDARD	ETPR2612CP01 ETPR2612CP03 ETPR2612CP06 ETPR2612CP07 ETPR2612CP09 ETPR2612CP13 ETPR2612CP14	297	SP	ROTOLO DA 1000 PZ CARTONI DA 36 ROTOLI
	ETICHETTA ADESIVA PER PREZZATRICE 26 x 12 mm PERMANENTE COLORI FLUO	ETPR2612FP50 ETPR2612FP51 ETPR2612FP52 ETPR2612FP53 ETPR2612FP54	297	SP	ROTOLO DA 1000 PZ CARTONI DA 36 ROTOLI
	ETICHETTA ADESIVA PER PREZZATRICE 26x 12 mm REMOVIBILE COLORI STANDARD	ETPR2612CR01 ETPR2612CR03 ETPR2612CR06 ETPR2612CR07 ETPR2612CR09 ETPR2612CR13 ETPR2612CR14	297	SP	ROTOLO DA 1000 PZ CARTONI DA 36 ROTOLI
	ETICHETTA ADESIVA PER PREZZATRICE 26x 12 mm REMOVIBILE COLORI FLUO	ETPR2612FR50 ETPR2612FR51 ETPR2612FR52 ETPR2612FR53 ETPR2612FR54	297	SP	ROTOLO DA 1000 PZ CARTONI DA 36 ROTOLI
	ETICHETTA ADESIVA PER PREZZATRICE 26 x 12 mm SURGELATI COLORI STANDARD	ETPR2612CS01 ETPR2612CS03 ETPR2612CS06 ETPR2612CS07 ETPR2612CS09 ETPR2612CS13 ETPR2612CS14	297	SP	ROTOLO DA 1000 PZ CARTONI DA 36 ROTOLI
	ETICHETTA ADESIVA PER PREZZATRICE 26 x 12 mm SURGELATI COLORI FLUO	ETPR2612FS50 ETPR2612FS51 ETPR2612FS52 ETPR2612FS53 ETPR2612FS54	297	SP	ROTOLO DA 1000 PZ CARTONI DA 36 ROTOLI



# PREZZATRICI, ETICHETTE E ROTOLI

IMMAGINE	DESCRIZIONE	CODICE E COLORE	PAG CAT	PREZZO	NOTE
<div style="border: 1px solid black; padding: 10px; width: fit-content; margin: auto;"> <b>26X16</b> </div>	ETICHETTA ADESIVA PER PREZZATRICE 26 x 16 mm PERMANENTE COLORI STANDARD	ETPR2616CP01 ETPR2616CP03 ETPR2616CP06 ETPR2616CP07 ETPR2616CP09 ETPR2616CP13 ETPR2616CP14	297	SP	ROTOLO DA 1000 PZ CARTONI DA 36 ROTOLI
	ETICHETTA ADESIVA PER PREZZATRICE 26 x 16 mm PERMANENTE COLORI FLUO	ETPR2616FP50 ETPR2616FP51 ETPR2616FP52 ETPR2616FP53 ETPR2616FP54	297	SP	ROTOLO DA 1000 PZ CARTONI DA 36 ROTOLI
	ETICHETTA ADESIVA PER PREZZATRICE 26 x 16 mm REMOVIBILE COLORI STANDARD	ETPR2616CR01 ETPR2616CR03 ETPR2616CR06 ETPR2616CR07 ETPR2616CR09 ETPR2616CR13 ETPR2616CR14	297	SP	ROTOLO DA 1000 PZ CARTONI DA 36 ROTOLI
	ETICHETTA ADESIVA PER PREZZATRICE 26 x 16 mm REMOVIBILE COLORI FLUO	ETPR2616FR50 ETPR2616FR51 ETPR2616FR52 ETPR2616FR53 ETPR2616FR54	297	SP	ROTOLO DA 1000 PZ CARTONI DA 36 ROTOLI
	ETICHETTA ADESIVA PER PREZZATRICE 26 x 16 mm SURGELATI COLORI STANDARD	ETPR2616CS01 ETPR2616CS03 ETPR2616CS06 ETPR2616CS07 ETPR2616CS09 ETPR2616CS13 ETPR2616CS14	297	SP	ROTOLO DA 1000 PZ CARTONI DA 36 ROTOLI
	ETICHETTA ADESIVA PER PREZZATRICE 26 x 16 mm SURGELATI COLORI FLUO	ETPR2616FS50 ETPR2616FS51 ETPR2616FS52 ETPR2616FS53 ETPR2616FS54	297	SP	ROTOLO DA 1000 PZ CARTONI DA 36 ROTOLI



# PREZZATRICI, ETICHETTE E ROTOLI

IMMAGINE	DESCRIZIONE	CODICE E COLORE	PAG CAT	PREZZO	NOTE
<div style="border: 1px solid black; width: 100px; height: 100px; display: flex; align-items: center; justify-content: center; margin: 0 auto;"> <b>26X19</b> </div>	ETICHETTA ADESIVA PER PREZZATRICE 26 x 19 mm PERMANENTE COLORI STANDARD	ETPR2619CP01 ETPR2619CP03 ETPR2619CP06 ETPR2619CP07 ETPR2619CP09 ETPR2619CP13 ETPR2619CP14	298	SP	ROTOLO DA 1000 PZ CARTONI DA 36 ROTOLI
	ETICHETTA ADESIVA PER PREZZATRICE 26 x 19 mm PERMANENTE COLORI FLUO	ETPR2619FP50 ETPR2619FP51 ETPR2619FP52 ETPR2619FP53 ETPR2619FP54	298	SP	ROTOLO DA 1000 PZ CARTONI DA 36 ROTOLI
	ETICHETTA ADESIVA PER PREZZATRICE 26 x 19 mm REMOVIBILE COLORI STANDARD	ETPR2619CR01 ETPR2619CR03 ETPR2619CR06 ETPR2619CR07 ETPR2619CR09 ETPR2619CR13 ETPR2619CR14	298	SP	ROTOLO DA 1000 PZ CARTONI DA 36 ROTOLI
	ETICHETTA ADESIVA PER PREZZATRICE 26 x 19 mm REMOVIBILE COLORI FLUO	ETPR2619FR50 ETPR2619FR51 ETPR2619FR52 ETPR2619FR53 ETPR2619FR54	298	SP	ROTOLO DA 1000 PZ CARTONI DA 36 ROTOLI
	ETICHETTA ADESIVA PER PREZZATRICE 26 x 19 mm SURGELATI COLORI STANDARD	ETPR2619CS01 ETPR2619CS03 ETPR2619CS06 ETPR2619CS07 ETPR2619CS09 ETPR2619CS13 ETPR2619CS14	298	SP	ROTOLO DA 1000 PZ CARTONI DA 36 ROTOLI
	ETICHETTA ADESIVA PER PREZZATRICE 26 x 19 mm SURGELATI COLORI FLUO	ETPR2619FS50 ETPR2619FS51 ETPR2619FS52 ETPR2619FS53 ETPR2619FS54	298	SP	ROTOLO DA 1000 PZ CARTONI DA 36 ROTOLI

# PREZZATRICI, ETICHETTE E ROTOLI

IMMAGINE	DESCRIZIONE	CODICE E COLORE	PAG CAT	PREZZO	NOTE
	ETICHETTA ADESIVA PER PREZZATRICE 26 x 19 mm PERMANENTE	ETPR2928HP	298	SP	
	ETICHETTA ADESIVA PER PREZZATRICE 26 x 19 mm REMOVIBILE	ETPR2619HR	298	SP	
	ETICHETTA ADESIVA PER PREZZATRICE 26 x 19 mm SURGELATI	ETPR2619HS	298	SP	
	ETICHETTA ADESIVA PER PREZZATRICE 29 x 28 mm PERMANENTE COLORI STANDARD	ETPR2928CP01 ETPR2928CP03 ETPR2928CP06 ETPR2928CP07 ETPR2928CP09 ETPR2928CP13 ETPR2928CP14	298	SP	ROTOLO DA 700 PZ CARTONI DA 30 ROTOLI
	ETICHETTA ADESIVA PER PREZZATRICE 29 x 28 mm PERMANENTE COLORI FLUO	ETPR2928FP50 ETPR2928FP51 ETPR2928FP52 ETPR2928FP53 ETPR2928FP54	298	SP	ROTOLO DA 700 PZ CARTONI DA 30 ROTOLI
	ETICHETTA ADESIVA PER PREZZATRICE 29 x 28 mm REMOVIBILE COLORI STANDARD	ETPR2928CR01 ETPR2928CR03 ETPR2928CR06 ETPR2928CR07 ETPR2928CR09 ETPR2928CR13 ETPR2928CR14	298	SP	ROTOLO DA 700 PZ CARTONI DA 30 ROTOLI
	ETICHETTA ADESIVA PER PREZZATRICE 29 x 28 mm REMOVIBILE COLORI FLUO	ETPR2928FR50 ETPR2928FR51 ETPR2928FR52 ETPR2928FR53 ETPR2928FR54	298	SP	ROTOLO DA 700 PZ CARTONI DA 30 ROTOLI
	ETICHETTA ADESIVA PER PREZZATRICE 29 x 28 mm SURGELATI COLORI STANDARD	ETPR2928CS01 ETPR2928CS03 ETPR2928CS06 ETPR2928CS07 ETPR2928CS09 ETPR2928CS13 ETPR2928CS14	298	SP	ROTOLO DA 700 PZ CARTONI DA 30 ROTOLI
	ETICHETTA ADESIVA PER PREZZATRICE 29 x 28 mm SURGELATI COLORI FLUO	ETPR2928FS50 ETPR2928FS51 ETPR2928FS52 ETPR2928FS53 ETPR2928FS54	298	SP	ROTOLO DA 700 PZ CARTONI DA 30 ROTOLI

# PREZZATRICI, ETICHETTE E ROTOLI

IMMAGINE	DESCRIZIONE	CODICE E COLORE	PAG CAT	PREZZO	NOTE
	ETICHETTA ADESIVA PER PREZZATRICE 29 x 28 mm PERMANENTE	ETPR2928HP	298	SP	
	ETICHETTA ADESIVA PER PREZZATRICE 29 x 28 mm REMOVIBILE	ETPR2928HR	298	SP	
	ETICHETTA ADESIVA PER PREZZATRICE 29 x 28 mm SURGELATI	ETPR2928HS	298	SP	
	ETICHETTA ADESIVA PER PREZZATRICE 32 x 19 mm PERMANENTE COLORI STANDARD	ETPR3219CP01 ETPR3219CP03 ETPR3219CP06 ETPR3219CP07 ETPR3219CP09 ETPR3219CP13 ETPR3219CP14	298	SP	ROTOLO DA 1000 PZ CARTONI DA 30 ROTOLI
	ETICHETTA ADESIVA PER PREZZATRICE 32 x 19 mm PERMANENTE COLORI FLUO	ETPR3219FP50 ETPR3219FP51 ETPR3219FP52 ETPR3219FP53 ETPR3219FP54	298	SP	ROTOLO DA 1000 PZ CARTONI DA 30 ROTOLI
	ETICHETTA ADESIVA PER PREZZATRICE 32 x 19 mm REMOVIBILE COLORI STANDARD	ETPR3219CR01 ETPR3219CR03 ETPR3219CR06 ETPR3219CR07 ETPR3219CR09 ETPR3219CR13 ETPR3219CR14	298	SP	ROTOLO DA 1000 PZ CARTONI DA 30 ROTOLI
	ETICHETTA ADESIVA PER PREZZATRICE 32 x 19 mm REMOVIBILE COLORI FLUO	ETPR3219FR50 ETPR3219FR51 ETPR3219FR52 ETPR3219FR53 ETPR3219FR54	298	SP	ROTOLO DA 1000 PZ CARTONI DA 30 ROTOLI
	ETICHETTA ADESIVA PER PREZZATRICE 32 x 19 mm SURGELATI COLORI STANDARD	ETPR3219CS01 ETPR3219CS03 ETPR3219CS06 ETPR3219CS07 ETPR3219CS09 ETPR3219CS13 ETPR3219CS14	298	SP	ROTOLO DA 1000 PZ CARTONI DA 30 ROTOLI
	ETICHETTA ADESIVA PER PREZZATRICE 32 x 19 mm SURGELATI COLORI FLUO	ETPR3219FS50 ETPR3219FS51 ETPR3219FS52 ETPR3219FS53 ETPR3219FS54	298	SP	ROTOLO DA 1000 PZ CARTONI DA 30 ROTOLI

# PREZZATRICI, ETICHETTE E ROTOLI



IMMAGINE	DESCRIZIONE	CODICE E COLORE	PAG CAT	PREZZO	NOTE
<div style="border: 1px solid black; width: 100px; height: 100px; display: flex; align-items: center; justify-content: center; margin: 20px auto;"> <b>37X19</b> </div>	ETICHETTA ADESIVA PER PREZZATRICE 37 x 19 mm PERMANENTE COLORI STANDARD	ETPR3719CP01 ETPR3719CP03 ETPR3719CP06 ETPR3719CP07 ETPR3719CP09 ETPR3719CP13 ETPR3719CP14	299	SP	ROTOLO DA 700 PZ CARTONI DA 24 ROTOLO
	ETICHETTA ADESIVA PER PREZZATRICE 37 x 19 mm PERMANENTE COLORI FLUO	ETPR3719FP50 ETPR3719FP51 ETPR3719FP52 ETPR3719FP53 ETPR3719FP54	299	SP	ROTOLO DA 700 PZ CARTONI DA 24 ROTOLO
	ETICHETTA ADESIVA PER PREZZATRICE 37 x 19 mm REMOVIBILE COLORI STANDARD	ETPR3719CR01 ETPR3719CR03 ETPR3719CR06 ETPR3719CR07 ETPR3719CR09 ETPR3719CR13 ETPR3719CR14	299	SP	ROTOLO DA 700 PZ CARTONI DA 24 ROTOLO
	ETICHETTA ADESIVA PER PREZZATRICE 37 x 19 mm REMOVIBILE COLORI FLUO	ETPR3719FR50 ETPR3719FR51 ETPR3719FR52 ETPR3719FR53 ETPR3719FR54	299	SP	ROTOLO DA 700 PZ CARTONI DA 24 ROTOLO
	ETICHETTA ADESIVA PER PREZZATRICE 37 x 19 mm SURGELATI COLORI STANDARD	ETPR3719CS01 ETPR3719CS03 ETPR3719CS06 ETPR3719CS07 ETPR3719CS09 ETPR3719CS13 ETPR3719CS14	299	SP	ROTOLO DA 700 PZ CARTONI DA 24 ROTOLO
	ETICHETTA ADESIVA PER PREZZATRICE 37 x 19 mm SURGELATI COLORI FLUO	ETPR3719FS50 ETPR3719FS51 ETPR3719FS52 ETPR3719FS53 ETPR3719FS54	299	SP	ROTOLO DA 700 PZ CARTONI DA 24 ROTOLO

# PREZZATRICI, ETICHETTE E ROTOLI

IMMAGINE	DESCRIZIONE	CODICE E COLORE	PAG CAT	PREZZO	NOTE
	ETICHETTA ADESIVA PER PREZZATRICE 37 x 28 mm PERMANENTE COLORI STANDARD	ETPR3728CP01 ETPR3728CP03 ETPR3728CP06 ETPR3728CP07 ETPR3728CP09 ETPR3728CP13 ETPR3728CP14	299	SP	ROTOLO DA 700 PZ CARTONI DA 24 ROTOLO
	ETICHETTA ADESIVA PER PREZZATRICE 37 x 28 mm PERMANENTE COLORI FLUO	ETPR3728FP50 ETPR3728FP51 ETPR3728FP52 ETPR3728FP53 ETPR3728FP54	299	SP	ROTOLO DA 700 PZ CARTONI DA 24 ROTOLO
	ETICHETTA ADESIVA PER PREZZATRICE 37 x 28 mm REMOVIBILE COLORI STANDARD	ETPR3728CR01 ETPR3728CR03 ETPR3728CR06 ETPR3728CR07 ETPR3728CR09 ETPR3728CR13 ETPR3728CR14	299	SP	ROTOLO DA 700 PZ CARTONI DA 24 ROTOLO
	ETICHETTA ADESIVA PER PREZZATRICE 37 x 28 mm REMOVIBILE COLORI FLUO	ETPR3728FR50 ETPR3728FR51 ETPR3728FR52 ETPR3728FR53 ETPR3728FR54	299	SP	ROTOLO DA 700 PZ CARTONI DA 24 ROTOLO
	ETICHETTA ADESIVA PER PREZZATRICE 37 x 28 mm SURGELATI COLORI STANDARD	ETPR3728CS01 ETPR3728CS03 ETPR3728CS06 ETPR3728CS07 ETPR3728CS09 ETPR3728CS13 ETPR3728CS14	299	SP	ROTOLO DA 700 PZ CARTONI DA 24 ROTOLO
	ETICHETTA ADESIVA PER PREZZATRICE 37 x 28 mm SURGELATI COLORI FLUO	ETPR3728FS50 ETPR3728FS51 ETPR3728FS52 ETPR3728FS53 ETPR3728FS54	299	SP	ROTOLO DA 700 PZ CARTONI DA 24 ROTOLO



# PREZZATRICI, ETICHETTE E ROTOLI

IMMAGINE	DESCRIZIONE	CODICE E COLORE	PAG CAT	PREZZO	NOTE
	ETICHETTA ADESIVA PER PREZZATRICE FLASH 37 x 28 mm PERMANENTE	ETPR3728HP	299	SP	
	ETICHETTA ADESIVA PER PREZZATRICE FLASH 37 x 28 mm REMOVIBILE	ETPR3728HR	299	SP	
	ETICHETTA ADESIVA PER PREZZATRICE FLASH 37 x 28 mm SURGELATI	ETPR3728HS	299	SP	
	ETICHETTA SAGOMATA ADESIVA PER PREZZATRICE 22 x 12 mm PERMANENTE COLORI STANDARD	ETPS2212CP01 ETPS2212CP03 ETPS2212CP06 ETPS2212CP07 ETPS2212CP09 ETPS2212CP13 ETPS2212CP14	299	SP	ROTOLO DA 1500 PZ CARTONI DA 42 ROTOLO
	ETICHETTA SAGOMATA ADESIVA PER PREZZATRICE 22 x 12 mm PERMANENTE COLORI FLUO	ETPS2212FP50 ETPS2212FP51 ETPS2212FP52 ETPS2212FP53 ETPS2212FP54	299	SP	ROTOLO DA 1500 PZ CARTONI DA 42 ROTOLO
	ETICHETTA SAGOMATA ADESIVA PER PREZZATRICE 22 x 12 mm REMOVIBILE COLORI STANDARD	ETPS2212CR01 ETPS2212CR03 ETPS2212CR06 ETPS2212CR07 ETPS2212CR09 ETPS2212CR13 ETPS2212CR14	299	SP	ROTOLO DA 1500 PZ CARTONI DA 42 ROTOLO
	ETICHETTA SAGOMATA ADESIVA PER PREZZATRICE 22 x 12 mm REMOVIBILE COLORI FLUO	ETPS2212FR50 ETPS2212FR51 ETPS2212FR52 ETPS2212FR53 ETPS2212FR54	299	SP	ROTOLO DA 1500 PZ CARTONI DA 42 ROTOLO
	ETICHETTA SAGOMATA ADESIVA PER PREZZATRICE 22 x 12 mm SURGELATI COLORI STANDARD	ETPS2212CS01 ETPS2212CS03 ETPS2212CS06 ETPS2212CS07 ETPS2212CS09 ETPS2212CS13 ETPS2212CS14	299	SP	ROTOLO DA 1500 PZ CARTONI DA 42 ROTOLO
	ETICHETTA SAGOMATA ADESIVA PER PREZZATRICE 22 x 12 mm SURGELATI COLORI FLUO	ETPS2212FS50 ETPS2212FS51 ETPS2212FS52 ETPS2212FS53 ETPS2212FS54	299	SP	ROTOLO DA 1500 PZ CARTONI DA 42 ROTOLO

# PREZZATRICI, ETICHETTE E ROTOLI

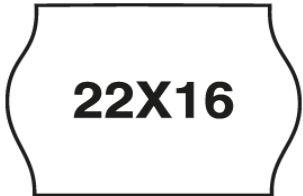
IMMAGINE	DESCRIZIONE	CODICE E COLORE	PAG CAT	PREZZO	NOTE
	ETICHETTA SAGOMATA ADESIVA PER PREZZATRICE 22 x 16 mm PERMANENTE COLORI STANDARD	ETPS2216CP01 ETPS2216CP03 ETPS2216CP06 ETPS2216CP07 ETPS2216CP09 ETPS2216CP13 ETPS2216CP14	300	SP	ROTOLO DA 1000 PZ CARTONI DA 42 ROTOLI
	ETICHETTA SAGOMATA ADESIVA PER PREZZATRICE 22 x 16 mm PERMANENTE COLORI FLUO	ETPS2216FP50 ETPS2216FP51 ETPS2216FP52 ETPS2216FP53 ETPS2216FP54	300	SP	ROTOLO DA 1000 PZ CARTONI DA 42 ROTOLI
	ETICHETTA SAGOMATA ADESIVA PER PREZZATRICE 22 x 16 mm REMOVIBILE COLORI STANDARD	ETPS2216CR01 ETPS2216CR03 ETPS2216CR06 ETPS2216CR07 ETPS2216CR09 ETPS2216CR13 ETPS2216CR14	300	SP	ROTOLO DA 1000 PZ CARTONI DA 42 ROTOLI
	ETICHETTA SAGOMATA ADESIVA PER PREZZATRICE 22 x 16 mm REMOVIBILE COLORI FLUO	ETPS2216FR50 ETPS2216FR51 ETPS2216FR52 ETPS2216FR53 ETPS2216FR54	300	SP	ROTOLO DA 1000 PZ CARTONI DA 42 ROTOLI
	ETICHETTA SAGOMATA ADESIVA PER PREZZATRICE 22 x 16 mm SURGELATI COLORI STANDARD	ETPS2216CS01 ETPS2216CS03 ETPS2216CS06 ETPS2216CS07 ETPS2216CS09 ETPS2216CS13 ETPS2216CS14	300	SP	ROTOLO DA 1000 PZ CARTONI DA 42 ROTOLI
	ETICHETTA SAGOMATA ADESIVA PER PREZZATRICE 22 x 16 mm SURGELATI COLORI FLUO	ETPS2216FS50 ETPS2216FS51 ETPS2216FS52 ETPS2216FS53 ETPS2216FS54	300	SP	ROTOLO DA 1000 PZ CARTONI DA 42 ROTOLI

# PREZZATRICI, ETICHETTE E ROTOLI

IMMAGINE	DESCRIZIONE	CODICE E COLORE	PAG CAT	PREZZO	NOTE
	ETICHETTA SAGOMATA ADESIVA PER PREZZATRICE 26 x 12 mm PERMANENTE COLORI STANDARD	ETPS2612CP01 ETPS2612CP03 ETPS2612CP06 ETPS2612CP07 ETPS2612CP09 ETPS2612CP13 ETPS2612CP14	300	SP	ROTOLI DA 1500 PZ CARTONI DA 36 ROTOLI
	ETICHETTA SAGOMATA ADESIVA PER PREZZATRICE 26 x 12 mm PERMANENTE COLORI FLUO	ETPS2612FP50 ETPS2612FP51 ETPS2612FP52 ETPS2612FP53 ETPS2612FP54	300	SP	ROTOLI DA 1500 PZ CARTONI DA 36 ROTOLI
	ETICHETTA SAGOMATA ADESIVA PER PREZZATRICE 26x 12 mm REMOVIBILE COLORI STANDARD	ETPS2612CR01 ETPS2612CR03 ETPS2612CR06 ETPS2612CR07 ETPS2612CR09 ETPS2612CR13 ETPS2612CR14	300	SP	ROTOLI DA 1500 PZ CARTONI DA 36 ROTOLI
	ETICHETTA SAGOMATA ADESIVA PER PREZZATRICE 26x 12 mm REMOVIBILE COLORI FLUO	ETPS2612FR50 ETPS2612FR51 ETPS2612FR52 ETPS2612FR53 ETPS2612FR54	300	SP	ROTOLI DA 1500 PZ CARTONI DA 36 ROTOLI
	ETICHETTA SAGOMATA ADESIVA PER PREZZATRICE 26 x 12 mm SURGELATI COLORI STANDARD	ETPS2612CS01 ETPS2612CS03 ETPS2612CS06 ETPS2612CS07 ETPS2612CS09 ETPS2612CS13 ETPS2612CS14	300	SP	ROTOLI DA 1500 PZ CARTONI DA 36 ROTOLI
	ETICHETTA SAGOMATA ADESIVA PER PREZZATRICE 26 x 12 mm SURGELATI COLORI FLUO	ETPS2612FS50 ETPS2612FS51 ETPS2612FS52 ETPS2612FS53 ETPS2612FS54	300	SP	ROTOLI DA 1500 PZ CARTONI DA 36 ROTOLI

# PREZZATRICI, ETICHETTE E ROTOLI

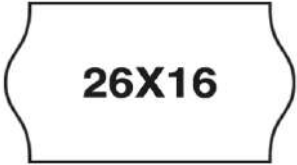
IMMAGINE	DESCRIZIONE	CODICE E COLORE	PAG CAT	PREZZO	NOTE
	ETICHETTA SAGOMATA ADESIVA PER PREZZATRICE 26 x 16 mm PERMANENTE COLORI STANDARD	ETPS2616CP01 ETPS2616CP03 ETPS2616CP06 ETPS2616CP07 ETPS2616CP09 ETPS2616CP13 ETPS2616CP14	300	SP	ROTOLO DA 1000 PZ CARTONI DA 36 ROTOLI
	ETICHETTA SAGOMATA ADESIVA PER PREZZATRICE 26 x 16 mm PERMANENTE COLORI FLUO	ETPS2616FP50 ETPS2616FP51 ETPS2616FP52 ETPS2616FP53 ETPS2616FP54	300	SP	ROTOLO DA 1000 PZ CARTONI DA 36 ROTOLI
	ETICHETTA SAGOMATA ADESIVA PER PREZZATRICE 26 x 16 mm REMOVIBILE COLORI STANDARD	ETPS2616CR01 ETPS2616CR03 ETPS2616CR06 ETPS2616CR07 ETPS2616CR09 ETPS2616CR13 ETPS2616CR14	300	SP	ROTOLO DA 1000 PZ CARTONI DA 36 ROTOLI
	ETICHETTA SAGOMATA ADESIVA PER PREZZATRICE 26 x 16 mm REMOVIBILE COLORI FLUO	ETPS2616FR50 ETPS2616FR51 ETPS2616FR52 ETPS2616FR53 ETPS2616FR54	300	SP	ROTOLO DA 1000 PZ CARTONI DA 36 ROTOLI
	ETICHETTA SAGOMATA ADESIVA PER PREZZATRICE 26 x 16 mm SURGELATI COLORI STANDARD	ETPS2616CS01 ETPS2616CS03 ETPS2616CS06 ETPS2616CS07 ETPS2616CS09 ETPS2616CS13 ETPS2616CS14	300	SP	ROTOLO DA 1000 PZ CARTONI DA 36 ROTOLI
	ETICHETTA SAGOMATA ADESIVA PER PREZZATRICE 26 x 16 mm SURGELATI COLORI FLUO	ETPS2616FS50 ETPS2616FS51 ETPS2616FS52 ETPS2616FS53 ETPS2616FS54	300	SP	ROTOLO DA 1000 PZ CARTONI DA 36 ROTOLI



# PREZZATRICI, ETICHETTE E ROTOLI

IMMAGINE	DESCRIZIONE	CODICE E COLORE	PAG CAT	PREZZO	NOTE
	ETICHETTA SAGOMATA ADESIVA PER PREZZATRICE 26 x 18 mm PERMANENTE COLORI STANDARD	ETPS2618CP01 ETPS2618CP03 ETPS2618CP06 ETPS2618CP07 ETPS2618CP09 ETPS2618CP13 ETPS2618CP14	300	SP	ROTOLO DA 1500 PZ CARTONI DA 36 ROTOLI
	ETICHETTA SAGOMATA ADESIVA PER PREZZATRICE 26 x 18 mm PERMANENTE COLORI FLUO	ETPS2618FP50 ETPS2618FP51 ETPS2618FP52 ETPS2618FP53 ETPS2618FP54	300	SP	ROTOLO DA 1500 PZ CARTONI DA 36 ROTOLI
	ETICHETTA SAGOMATA ADESIVA PER PREZZATRICE 26 x 18 mm REMOVIBILE COLORI STANDARD	ETPS2618CR01 ETPS2618CR03 ETPS2618CR06 ETPS2618CR07 ETPS2618CR09 ETPS2618CR13 ETPS2618CR14	300	SP	ROTOLO DA 1500 PZ CARTONI DA 36 ROTOLI
	ETICHETTA SAGOMATA ADESIVA PER PREZZATRICE 26 x 18 mm REMOVIBILE COLORI FLUO	ETPS2618FR50 ETPS2618FR51 ETPS2618FR52 ETPS2618FR53 ETPS2618FR54	300	SP	ROTOLO DA 1500 PZ CARTONI DA 36 ROTOLI
	ETICHETTA SAGOMATA ADESIVA PER PREZZATRICE 26 x 18 mm SURGELATI COLORI STANDARD	ETPS2618CS01 ETPS2618CS03 ETPS2618CS06 ETPS2618CS07 ETPS2618CS09 ETPS2618CS13 ETPS2618CS14	300	SP	ROTOLO DA 1500 PZ CARTONI DA 36 ROTOLI
	ETICHETTA SAGOMATA ADESIVA PER PREZZATRICE 26 x 18 mm SURGELATI COLORI FLUO	ETPS2618FS50 ETPS2618FS51 ETPS2618FS52 ETPS2618FS53 ETPS2618FS54	300	SP	ROTOLO DA 1500 PZ CARTONI DA 36 ROTOLI

# PREZZATRICI, ETICHETTE E ROTOLI

IMMAGINE	DESCRIZIONE	CODICE E COLORE	PAG CAT	PREZZO	NOTE
 <p><b>32X19</b></p>	ETICHETTA SAGOMATA ADESIVA PER PREZZATRICE 32 x 19 mm PERMANENTE COLORI STANDARD	ETPS3219CP01 ETPS3219CP03 ETPS3219CP06 ETPS3219CP07 ETPS3219CP09 ETPS3219CP13 ETPS3219CP14	300	SP	ROTOLO DA 1000 PZ CARTONI DA 36 ROTOLI
	ETICHETTA SAGOMATA ADESIVA PER PREZZATRICE 32 x 19 mm PERMANENTE COLORI FLUO	ETPS3219FP50 ETPS3219FP51 ETPS3219FP52 ETPS3219FP53 ETPS3219FP54	300	SP	ROTOLO DA 1000 PZ CARTONI DA 36 ROTOLI
	ETICHETTA SAGOMATA ADESIVA PER PREZZATRICE 32 x 19 mm REMOVIBILE COLORI STANDARD	ETPS3219CR01 ETPS3219CR03 ETPS3219CR06 ETPS3219CR07 ETPS3219CR09 ETPS3219CR13 ETPS3219CR14	300	SP	ROTOLO DA 1000 PZ CARTONI DA 36 ROTOLI
	ETICHETTA SAGOMATA ADESIVA PER PREZZATRICE 32 x 19 mm REMOVIBILE COLORI FLUO	ETPS3219FR50 ETPS3219FR51 ETPS3219FR52 ETPS3219FR53 ETPS3219FR54	300	SP	ROTOLO DA 1000 PZ CARTONI DA 36 ROTOLI
	ETICHETTA SAGOMATA ADESIVA PER PREZZATRICE 32 x 19 mm SURGELATI COLORI STANDARD	ETPS3219CS01 ETPS3219CS03 ETPS3219CS06 ETPS3219CS07 ETPS3219CS09 ETPS3219CS13 ETPS3219CS14	300	SP	ROTOLO DA 1000 PZ CARTONI DA 36 ROTOLI
	ETICHETTA SAGOMATA ADESIVA PER PREZZATRICE 32 x 19 mm SURGELATI COLORI FLUO	ETPS3219FS50 ETPS3219FS51 ETPS3219FS52 ETPS3219FS53 ETPS3219FS54	300	SP	ROTOLO DA 1000 PZ CARTONI DA 36 ROTOLI

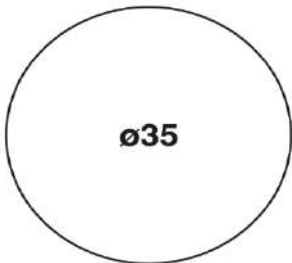
# PREZZATRICI, ETICHETTE E ROTOLI

IMMAGINE	DESCRIZIONE	CODICE E COLORE	PAG CAT	PREZZO	NOTE
	ETICHETTA ADESIVA CIRCOLARE PER PREZZATRICE Ø 35 mm PERMANENTE COLORI STANDARD	ETPTD035CP01 ETPTD035CP03 ETPTD035CP06 ETPTD035CP07 ETPTD035CP09 ETPTD035CP13 ETPTD035CP14	301	SP	ROTOLE DA 400 PZ CARTONI DA 24 ROTOLE
	ETICHETTA ADESIVA CIRCOLARE PER PREZZATRICE Ø 35 mm PERMANENTE COLORI FLUO	ETPTD035FP50 ETPTD035FP51 ETPTD035FP52 ETPTD035FP53 ETPTD035FP54	301	SP	ROTOLE DA 400 PZ CARTONI DA 24 ROTOLE
	ETICHETTA ADESIVA CIRCOLARE PER PREZZATRICE Ø 35 mm REMOVIBILE COLORI STANDARD	ETPTD035CR01 ETPTD035CR03 ETPTD035CR06 ETPTD035CR07 ETPTD035CR09 ETPTD035CR13 ETPTD035CR14	301	SP	ROTOLE DA 400 PZ CARTONI DA 24 ROTOLE
	ETICHETTA ADESIVA CIRCOLARE PER PREZZATRICE Ø 35 mm REMOVIBILE COLORI FLUO	ETPTD035FR50 ETPTD035FR51 ETPTD035FR52 ETPTD035FR53 ETPTD035FR54	301	SP	ROTOLE DA 400 PZ CARTONI DA 24 ROTOLE
	ETICHETTA ADESIVA CIRCOLARE PER PREZZATRICE Ø 35 mm SURGELATI COLORI STANDARD	ETPTD035CS01 ETPTD035CS03 ETPTD035CS06 ETPTD035CS07 ETPTD035CS09 ETPTD035CS13 ETPTD035CS14	301	SP	ROTOLE DA 400 PZ CARTONI DA 24 ROTOLE
	ETICHETTA ADESIVA CIRCOLARE PER PREZZATRICE Ø 35 mm SURGELATI COLORI FLUO	ETPTD035FS50 ETPTD035FS51 ETPTD035FS52 ETPTD035FS53 ETPTD035FS54	301	SP	ROTOLE DA 400 PZ CARTONI DA 24 ROTOLE
		ETICHETTA ADESIVA CIRCOLARE PER PREZZATRICE FLASH Ø 35 mm PERMANENTE	ETPTDH35HP	301	SP
ETICHETTA ADESIVA CIRCOLARE PER PREZZATRICE FLASH Ø 35 mm REMOVIBILE		ETPTH035HR	301	SP	
ETICHETTA ADESIVA CIRCOLARE PER PREZZATRICE FLASH Ø 35 mm SURGELATI		ETPTH035HS	301	SP	

# PREZZATRICI, ETICHETTE E ROTOLI

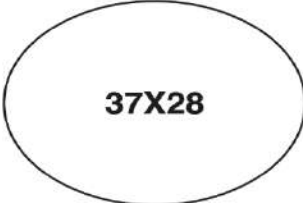
IMMAGINE	DESCRIZIONE	CODICE E COLORE	PAG CAT	PREZZO	NOTE
 <p><b>37X28</b></p>	ETICHETTA ADESIVA OVALE PER PREZZATRICE 37 x 28 mm PERMANENTE COLORI STANDARD	ETPVOV37CP01 ETPVOV37CP03 ETPVOV37CP06 ETPVOV37CP07 ETPVOV37CP09 ETPVOV37CP13 ETPVOV37CP14	301	SP	ROTOLO DA 500 PZ CARTONI DA 24 ROTOLO
	ETICHETTA ADESIVA OVALE PER PREZZATRICE 37 x 28 mm PERMANENTE COLORI FLUO	ETPVOV37FP50 ETPVOV37FP51 ETPVOV37FP52 ETPVOV37FP53 ETPVOV37FP54	301	SP	ROTOLO DA 500 PZ CARTONI DA 24 ROTOLO
	ETICHETTA ADESIVA OVALE PER PREZZATRICE 37 x 28 mm REMOVIBILE COLORI STANDARD	ETPVOV37CR01 ETPVOV37CR03 ETPVOV37CR06 ETPVOV37CR07 ETPVOV37CR09 ETPVOV37CR13 ETPVOV37CR14	301	SP	ROTOLO DA 500 PZ CARTONI DA 24 ROTOLO
	ETICHETTA ADESIVA OVALE PER PREZZATRICE 37 X 28 mm REMOVIBILE COLORI FLUO	ETPVOV37FR50 ETPVOV37FR51 ETPVOV37FR52 ETPVOV37FR53 ETPVOV37FR54	301	SP	ROTOLO DA 500 PZ CARTONI DA 24 ROTOLO
	ETICHETTA ADESIVA OVALE PER PREZZATRICE 37 x 28 mm SURGELATI COLORI STANDARD	ETPVOV37CS01 ETPVOV37CS03 ETPVOV37CS06 ETPVOV37CS07 ETPVOV37CS09 ETPVOV37CS13 ETPVOV37CS14	301	SP	ROTOLO DA 500 PZ CARTONI DA 24 ROTOLO
	ETICHETTA ADESIVA OVALE PER PREZZATRICE 37 x 28 mm SURGELATI COLORI FLUO	ETPVOV37FS50 ETPVOV37FS51 ETPVOV37FS52 ETPVOV37FS53 ETPVOV37FS54	301	SP	ROTOLO DA 500 PZ CARTONI DA 24 ROTOLO



# PREZZATRICI, ETICHETTE E ROTOLI

IMMAGINE	DESCRIZIONE	CODICE E COLORE	PAG CAT	PREZZO	NOTE
	ETICHETTA ADESIVA OVALE PER PREZZATRICE FLASH 37 x 28 mm PERMANENTE	ETPVOV37HP	301	SP	
	ETICHETTA ADESIVA OVALE PER PREZZATRICE FLASH 37 x 28 mm REMOVIBILE	ETPVOV37HR	301	SP	
	ETICHETTA ADESIVA OVALE PER PREZZATRICE FLASH 37 x 28 mm SURGELATI	ETPVOV37HS	301	SP	
	TE200 SERIES	PRPRTTE200	302	SP	
	G500 SERIES	PRPRTG500S	303	SP	
	G530 SERIES	PRPRTG530S	303	SP	
	ZX 420i SERIES	PRPRTZX420I	304	SP	
	ZX 430i SERIES	PRPRTZX430I	304	SP	
	ZX1200 SERIES	PRPRTZX1200S	305	SP	
	ZX1300	PRPRTZX1300S	305	SP	

# PREZZATRICI, ETICHETTE E ROTOLI

IMMAGINE	DESCRIZIONE	CODICE E COLORE	PAG CAT	PREZZO	NOTE
	GODEX T10	PRGODEXT10	306	SP	
	GODEX T20	PRGODEXT20	306	SP	
	GODEX T30	PRGODEXT30	306	SP	
	SCANNER BARCODE 1D/2D MANUALE CON CAVO	PRLETCV26	308	SP	
	SCANNER BARCODE 1D/2D WIRELESS BLUETOOTH	PRLETCV27	309	SP	

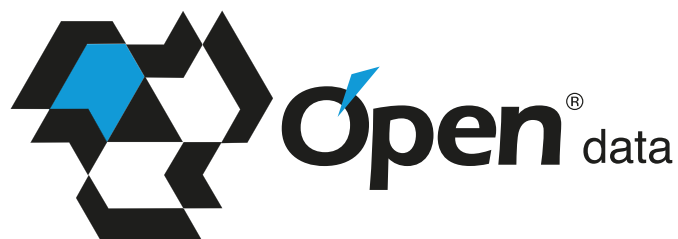

*Via Professor Filippo Manna 27 - Complesso Millefiori*

*INFO@GEKOSHOP.IT - INFO: 081 18214718*



[WWW.GEKOSHOP.IT](http://WWW.GEKOSHOP.IT)